

QUEST

A MAGAZINE DEVOTED EXCLUSIVELY TO
CITIZEN WIRELESS

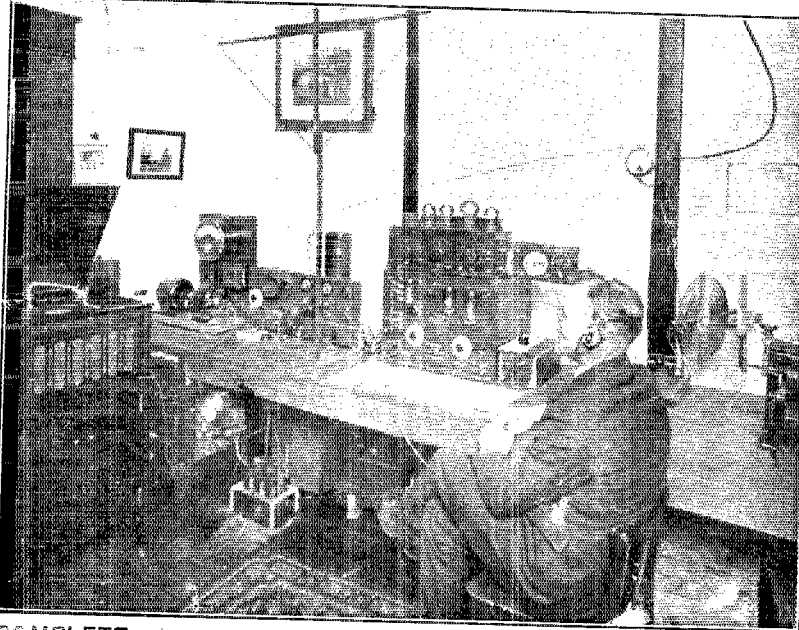

COMPLETE DESCRIPTION 5ZG. DALLAS, TEXAS IN THIS ISSUE

PUBLISHED BY THE
AMERICAN RADIO RELAY LEAGUE



AUGUST, 1921

20 CENTS

H.R. HICK

A TUBE FOR EVERY PURPOSE

RADIOTRON VACUUM TUBES are designed for reception, amplification, and transmission. There is a tube for every purpose. RADIOTRONS in your station are a guarantee of efficiency and dependability. Prove this for yourself by adopting RADIOTRONS today.

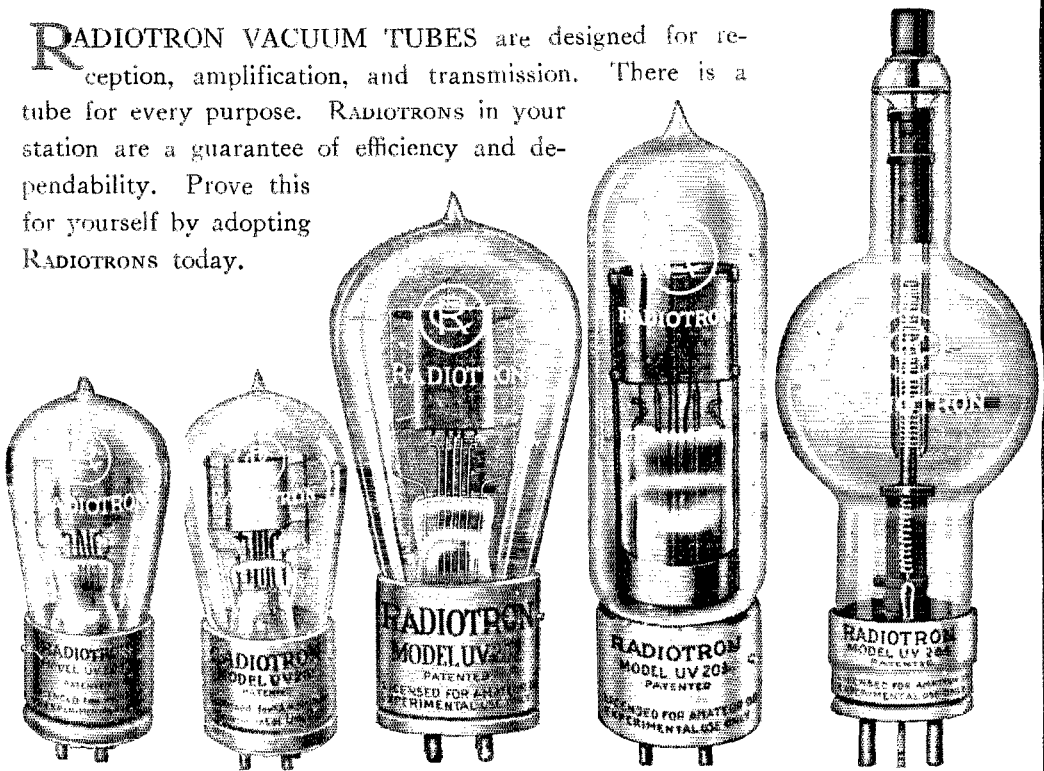

| Tube | Radiotron U.V. 200 | Radiotron U.V. 201 | Radiotron U.V. 202 | Radiotron U.V. 203 | Radiotron U.V. 204 |
|---------------|--------------------|--------------------|--------------------|---------------------|----------------------|
| Fil. Current | 1.1 Amps. | 1. Amps. | 2.35 Amps. | 6.5 Amps. | 15. Amps. |
| Plate Voltage | 15-22.5 V. | 40-100 V. | 350 V. Normal | 1000 V. Normal | 2000 V. Normal |
| Plate Current | | | .045 Amps. | .15 Amps. | .25 Amps. |
| Price | \$5.00 | \$6.50 | \$8.00 | \$30.00 | \$110.00 |
| Use | Detector | Amplifier | 5 Watt Transmitter | 50 watt Transmitter | 250 watt Transmitter |

ARE YOU USING THE

Designed specially for use with the Radiotron U.V. 200 and U.V. 201 Vacuum Tubes.

U.V. 712

**RADIO CORPORATION
INTERVALVE
TRANSFORMER?**

PRICE, \$7.50

(Shipping weight 2 lbs.)

Atlantic Radio Company, Inc.

88 Broad Street
Boston, 9 Mass.

Branch--15 Temple Street
Portland, Maine



*"This mark
your guarantee"*

- ALBANY, N. Y.
Shotton Radio Mfg. Co.
8 Market St.
- ASHEVILLE, N. C.
Hi-Grade Wireless Instru-
ment Co.
- ATLANTIC CITY, N. J.
Paramount Radio Supply
Arkansas & Pacific Sts.
- BOSTON, MASS.
Atlantic Radio Co.
88 Broad St.
- BROOKLYN, N. Y.
Kelly & Phillips,
112 Flatbush Ave.
- CHICAGO, ILL.
Chicago Radio Lab.
1316 Carmen Ave.
- EUREKA, ILL.
Klaus Radio Co.
Branch, Peoria, Ill.
- KANSAS CITY, MO.
McCreary Radio Supply
4th and Delaware Sts.
- McKEESPORT, PA.
K. & L. Electric Co.
427 Olive Street
- NEW BRUNSWICK
NEW JERSEY
Geo. N. DeLaplaine
306 George St. and
8th & Magnolia Sts.
- NEW ORLEANS, LA.
Rose Radio Supply,
604 Gravier St.
- NEWARK, N. J.
A. H. Corwin & Co.
4 West Park St.
- OMAHA, NEBRASKA
O-B Radio Supply Co.
406 Brown Building.
- PHILADELPHIA, PENN.
Philadelphia School of
Wireless Telegraphy
Broad and Cherry Sts.
- PITTSBURGH, PENN.
Radio Electric Co.
3407 Fifth Ave.
- PLAINFIELD, N. J.
Paul R. Collier,
154 E. Front St.
- PORTLAND, ME.
Atlantic Radio Co.,
15 Temple St.
- PROVIDENCE, R. I.
Rhode Island Rec. Equip.
Co.
45 Washingt. St.
- SCRANTON, PENN.
Shotton Radio Mfg. Co.
P. O. Box 2
Branch, 8 Kingsbury St.
Jamestown, N. Y.
- SEATTLE, WASH.
Northwest Radio Service
609 Fourth Ave.
- WASHINGTON, D. C.
Eastern Radio & Elec-
tric Company,
1405 Florida Avenue.
- Canadian*
MONTREAL, QUEBEC.
J. B. Miller
136 Vendome Ave. N.D.G.
- TORONTO, ONTARIO.
The Vimy Supply Co.
567 College St.

RADISCO

"Your Assurance of Satisfactory Performance"

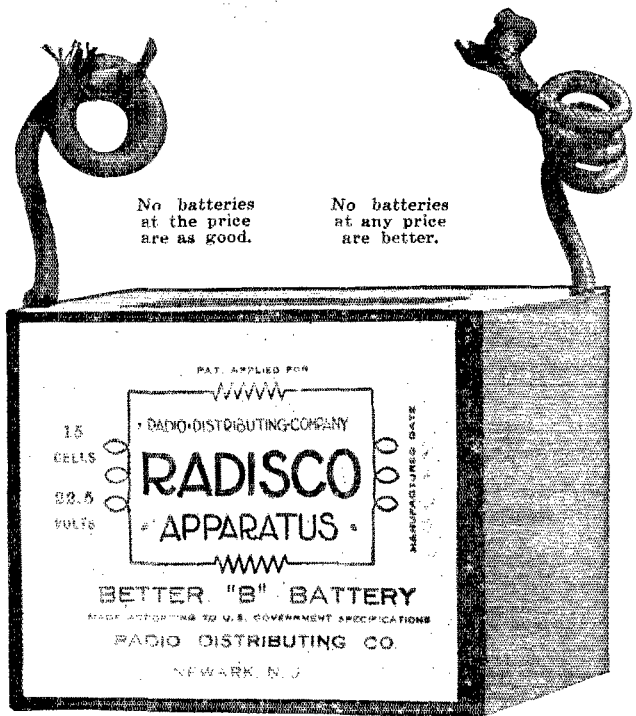

No batteries
at the price
are as good.

No batteries
at any price
are better.

RADISCO BETTER "B" BATTERIES

are an investment in satisfaction! To pay less is to sacrifice essential elements of quality. To pay more is unnecessary—a needless use of money which might better be put into other apparatus. Operating life 600 to 1000 hours, 15 cells, 22½ V. No. 1 (3½ x 2 x 2½ in.).....\$1.50
Shipping weight 2 pounds
No. 2 (6½ x 4 x 3 in.).....\$2.65
Shipping weight 5 pounds.

Larger size has variable voltage feature. Tapped in groups of three cells. Ask your dealer to explain it.

For radio phone work, Radisco Better "B" Batteries provide a reliable source of power, without the disagreeable hum of a motor generator or the rectified 60 cycle tone.

**RADIO DISTRIBUTING COMPANY
NEWARK, NEW JERSEY**

RADISCO

"Your Assurance of Satisfactory Performance"

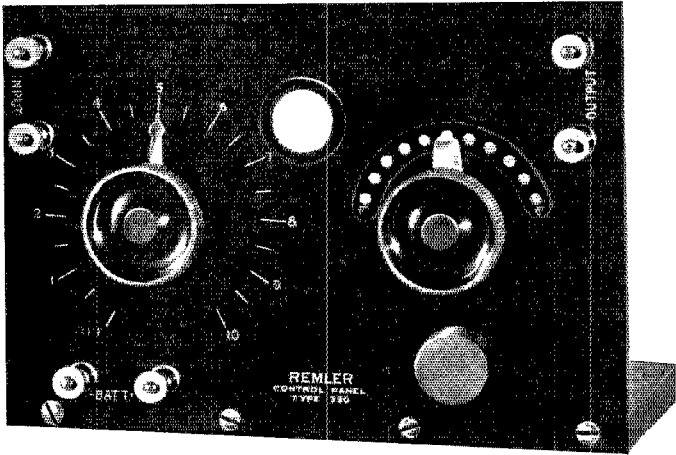

Price
\$ 8.⁰⁰

REMLER

TYPE 330

DETECTOR PANEL

A-Battery Potentiometer Plate Voltage Control

The Remler panel is genuine molded bakelite, 5x7 $\frac{1}{4}$ x $\frac{1}{8}$ inches. The surface is highly polished glossy black and the lettering and scales are recessed and filled with white enamel. The filament current is controlled by REMLER No. 810 RHEOSTAT, back mounted, and is provided with an open position. REMLER No. 93 POTENTIOMETER connected across the storage battery provides the close adjustment of plate potential necessary for sensitive detector action. Terminals at the back of the panel are provided with flexible leads for the B Battery connection. The rheostat and potentiometer knobs are polished bakelite, 1 $\frac{3}{8}$ in. diameter. The GRID LEAK is variable and grid condenser back mounted is the correct capacity for the new gas content detector tubes. REMLER No. 92 V. T. SOCKET is used and supports the tube vertically, insuring maximum filament life. Its all bakelite construction tends to eliminate induction and ground hums. An orifice in the panel permits a view of the filament. Binding posts and all metal parts are finished in polished nickel. The panel is mounted on a hardwood base 7 $\frac{1}{4}$ x 3 $\frac{1}{2}$ inches, finished in black, but can readily be mounted in a cabinet. The wiring is the approved bus bar type, and is laid out so that the input and output terminals are at opposite sides.

Send for Bulletin No. 1002 and 1003 on the Remler Bakelite Detector and Amplifier Panels, Types 330, 331 and 333. Two or more of these panels can be mounted in a cabinet to make any desired detector-amplifier combination.

DEALERS:—There is an exclusive and very profitable proposition for you on Remler Apparatus. Write for full particulars.

Remler Apparatus Radiates Quality

REMLER RADIO MFG. CO.

E. T. CUNNINGHAM, General Manager

163 Sutter St.,

San Francisco, Calif.

CUNNINGHAM

TYPE C 300 TYPE C 301

RECEIVING TUBES

Operating Instructions and Circuit Diagrams including an Explanation of Vacuum Tube Operation and Characteristics

E. J. Cunningham

TRADE MARK AS
AUDIOTRON MANUFACTURING CO.
SAN FRANCISCO

11 Montgomerly St.

GE

The trade-mark GE is the guarantee of these quality tubes. Each tube is built to most rigid specifications.

This 8-page Cunningham Direction Sheet is now in the hands of your dealer and is supplied with each receiving tube.

CUNNINGHAM TUBE SERVICE

Nationally Known Since 1915
General Electric Quality Plus Cunningham Service

Cunningham Type C-300
Gas Content Detector Tube
of low plate voltage. Price \$5.00.

Cunningham Type C-301
Pliotron or Navy Type. High
Vacuum Amplifier. Price \$6.50.

| Model | TRANSMITTER TUBE SPECIFICATIONS | | | Plate Voltage | Price |
|-------|---------------------------------|-------|-------------------|---------------|---------|
| | Output Conservative Rating | Amps. | Filament Volts | | |
| C 302 | 5 watts | 2.35 | 7.5 | 350-400 | \$ 8 00 |
| C 303 | 50 watts | 6.5 | 10. | 1000 | 30.00 |
| C 304 | 250 watts | 15. | 12. | 4000 Max | 110.00 |

C 304 job. New York or San Francisco.
C 302 is mounted on the standard four prong receiving tube base.
The larger tubes have special bases.

Cunningham Service is more than a trade expression—it is an in-built quality which has served the most rigid tube tests in the radio field for the past six years.
DEALERS—Standard Packages F. O. B. Cleveland, San Francisco, New York. Broken Packages F. O. B. San Francisco

E. J. Cunningham

Trading as Audiotron Mfg. Company
since 1915.

35 MONTGOMERY STREET

SAN FRANCISCO, CAL.



ASSURANCE

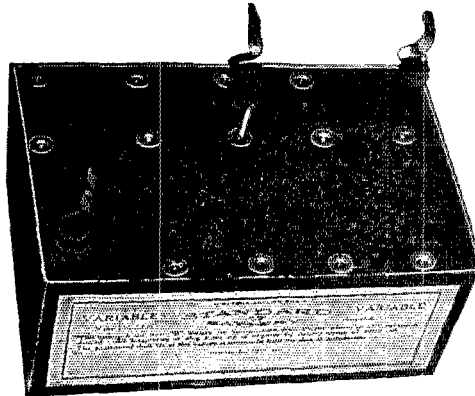

Cast en bloc
Moisture proof
Ruggedly Built

Fully Guaranteed
Long Life
Silent Performance

When you need a "B" battery and want to feel assured of long life and satisfactory service, buy the guaranteed STANDARD VT BATTERY. Built into the STANDARD VT BATTERY is quality—every STANDARD VT BATTERY is a solid moulded unit of power that will give the service which you expect.

Reasonably priced, these batteries are offered to meet the pockets of all. The next time you are in need of a "B" battery ask your dealer about the STANDARD VT BATTERIES, especially our #7600, which are now in the hands of the most reliable dealers throughout the United States and Canada.

| Number | Description | Price |
|--------|---------------------------|--------|
| 7623 | Small type untapped | \$1.50 |
| 7625 | Large type untapped | 2.65 |
| 7600 | Large semi-variable type | 3.00 |
| 7650 | Large type fully variable | 3.50 |

DEALERS—Have you our literature and prices?

Pacents Electric Company, Inc.

Louis Gerard Pacent, President

SOLE DISTRIBUTORS FOR

Wicony's Complete Line of "Eventual" Apparatus.

Duo-Lateral Coils,
Standard VT Batteries,

Pacents Universal Plugs,
Dubilier Condensers,

Sullivan Apparatus,
Seibt Condensers,

Special Distributors for Brandes Phones

150 Nassau Street,

Telephone
Beekman 5810

New York City

QST

The Official Organ of the A.R.R.L.

VOLUME V.

AUGUST, 1921

No. 1

| | | |
|--|-----------------------------|-----|
| Come to The Convention! | | 7 |
| Modulation in Radio Telephony—Part II | <i>R. A. Heising</i> | 9 |
| A Dream | <i>The Old Boy</i> | 15 |
| Spark Reception on Honeycombs—Part II | <i>Chas. Kinyon</i> | 16 |
| Quiet Hours for Listening for DX | <i>The Traffic Manager</i> | 18 |
| Our Board of Direction | | 19 |
| Amateur Quenched Gap Problems | <i>H. J. Tyzzer</i> | 20 |
| Reception of 200-meter Signals by Means of a Loop and an Armstrong Super-Heterodyne | <i>Leroy M. E. Clausing</i> | 24 |
| New Apparatus | | 26 |
| The C.W. Transmitter at 8ZV | <i>Henry L. Ley</i> | 28 |
| Editorials | | 31 |
| The Operating Department | | 34 |
| Amateur Radio Stations | | 43 |
| With the Affiliated Clubs | | 47 |
| "Strays" | | 49 |
| Calls Heard | | 52 |
| June Station Reports | | 56 |
| Radio Communications by the Amateurs | | 57 |
| QST's Index of Advertisers | | 119 |

QST is published monthly by The American Radio Relay League, Inc., at Hartford, Conn. Kenneth B. Warner (Secretary, A.R.R.L.), Business Manager, Editor.

Edwin C. Adams, Advertising Manager.
Subscription price in United States, Possessions, and Canada, \$2.00 per year.
Foreign, \$2.50. Single Copies, 20 cents.

Entered as second-class matter May 29, 1919, at the post office of Hartford, Connecticut, under the Act of March 3, 1879.

Copyright, 1921, by The American Radio Relay League, Inc.
Title registered at United States Patent Office.

THE AMERICAN RADIO RELAY LEAGUE, Inc.

HARTFORD, CONN.

THE AMERICAN RADIO RELAY LEAGUE

"A national non-commercial organization of radio amateurs, bonded for the more effective relaying of friendly messages between their stations, for legislative protection, and for scientific growth."

President
HIRAM PERCY MAXIM
Hartford, Conn.

Vice President
CHAS. A. SERVICE, JR.
Bala, Pa.

A. E. BESSEY
Sunnyvale, Calif.
V. F. CAMP
Brightwaters, L. I.
J. M. CLAYTON
Little Rock, Ark.
F. M. CORLETT
Dallas, Tex.
S. KRUSE
Washington, D. C.
W. T. GRAVELY
Danville, Va.

ATLANTIC DIVISION
Manager
Chas. H. Stewart
St. David's, Pa.

Asst. Mgr., Central Sec.
C. J. Goette
1624 Hamilton Ave.
Woodhaven, L. I.

Asst. Mgr., Southern Sec.
Edw. R. Duvall
3909 Cottage Ave.
Baltimore, Md.

EAST GULF DIVISION
Manager
E. H. Merritt
192 W. North Ave.
Atlanta, Ga.

CENTRAL DIVISION
Manager
R. H. G. Mathews
6433 Ravenswood Ave.
Chicago

Assistant Manager
L. A. Pease
2256 W. 24th St.
Chicago

ALASKAN DIVISION
Manager
Roy Anderson, 71T
P. O. Box 206
Ketchikan, Alaska

C. S. BALLANTINE
WM. C. BALLARD, Jr.
LEROY M. E. CLAUSING
FRANK CONRAD
LEO C. YOUNG

OFFICERS

Traffic Manager
F. H. SCHNELL
1045 Main St.,
Hartford, Conn.

Treasurer
A. A. HEBERT
Nutley, N. J.

Secretary
K. B. WARNER
Hartford, Conn.

DIRECTORS

F. F. HAMILTON
Indianapolis
A. A. HEBERT
Nutley, N. J.
HIRAM PERCY MAXIM
Hartford, Conn.
C. A. SERVICE, JR.
Bala, Pa.

H. L. STANLEY
Babylon, L. I.
C. H. STEWART
St. David's, Pa.
E. B. WARNER
Hartford, Conn.
M. B. WEST
Waukegan, Ill.
F. H. SCHNELL
Hartford, Conn.
H. M. ANTHONY
Muncie, Ind.

OPERATING DEPARTMENT

WEST GULF DIVISION
Manager
Frank M. Corlett
1101 East Eighth St.
Dallas, Tex.

Assistant Manager
Raymond L. White
900 No. Preston St.
Ennis, Tex.

PACIFIC DIVISION
Manager
A. E. Bessey
Sunnyvale, Calif.

Assistant Manager
E. G. Arnold
181 No. 17th St.
San Jose, Calif.

ST. LAWRENCE DIVISION
Manager
Albert J. Lorimer
243 Mackay St.
Montreal, Que.

ONTARIO DIVISION
Manager
A. H. Keith Russell
353 Markham St.
Toronto, Ont.

DAKOTA DIVISION
Manager
Boyd Phelps
3844 First Ave., South
Minneapolis, Minn.

NEW ENGLAND DIVISION
Manager
Guy E. Entwistle
137 Sutherland Road
Brookline, Mass.

ROANOKE DIVISION
Manager
W. T. Gravelly
854 Main St.
Danville, Va.

DELTA DIVISION
Manager
John M. Clayton
1301 Welch St.
Little Rock, Ark.
Assistant Manager
Hubert E. de Ben
1044 City Park Ave.,
New Orleans.

ROCKY MOUNTAIN DIV.
Manager
M. S. Andelin
Richfield, Utah

MIDWEST DIVISION
Manager
L. A. Benson
4942 Wiesehan Ave.
St. Louis

NORTHWESTERN DIV.
Acting Manager
R. T. Galvean
460 Miller St.
Portland, Ore.

Asst. Mgr., Eastern Sec.
H. E. Cutting
Box 517,
Bozeman, Mont.

ADVISORY TECHNICAL COMMITTEE

MINTON CRONKHITE
J. H. DELLINGER
C. L. FARRAND
PAUL F. GODLEY

L. A. HAZELTINE
C. D. TUSKA
R. H. G. MATHEWS
J. O. SMITH
S. KRUSE

Address General Correspondence to Executive Headquarters, Hartford, Conn.

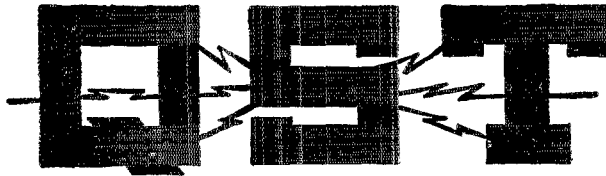

A Magazine Devoted Exclusively to the Radio Amateur

Come to the Convention!

THIS issue of QST is our last opportunity to tell you about the big meeting—the First National A.R. R.L. Convention and Radio Show—which will convene in Chicago on the morning of August 31st and provide four days as chock-full of things of interest to radio men as we can think of, concluding with an immense banquet on the night of September 3d.

The convention was originally announced for five days, but that seemed a little long and so August 30th is now given over to meeting arrivals and making reservations, etc., the first meeting being called to order at 10:30 a.m. on the 31st. Now just glance over this brief outline of the program:

First Day

The first meeting will be a general one, opened by addresses of welcome by the Central Division Manager and the Chicago City Manager, followed by our president, Hiram Percy Maxim, who will formally open the convention. President Harding and the Secretaries of Commerce and the Navy are invited to address us but at this writing their replies have not been received. Representatives of the A.T.&T. Co. and the Radio Corporation are also expected to address us at this meeting on the relations of their companies with us amateurs.

At 1:30 p.m. there will be a meeting of the Central Division organization, to which all are invited. In addition to talks by Manager Mathews and his assistants B. W. Stolte and L. A. Pease, district reports will be rendered by Superintendents Mrs. Chas. Candler, Henry Klaus, H. J. Burhop, C. E. Darr, J. A. Kolb, Jr., R. D. McCommon, K. A. Duerk, F. F. Hamilton, and M. W. Hutchinson.

At 3:30 p.m. the main business meeting of the convention meets for the discussion of organization, interference control, time division, police co-operation, traffic regulation, observation of laws, legislative matters, etc. The speakers at present scheduled are the Secretaries of Commerce

and the Navy, Messrs. H. P. Maxim, M. B. West, F. H. Schnell, N. E. Wunderlich, F. M. J. Murphy, Mrs. Emma Candler, S. Kruse, Radio Inspectors C. C. Kolster and L. R. Schmitt, E. B. Warner, A. E. Bessey, F. M. Corlett, Boyd Phelps, E. S. Rogers, R. H. G. Mathews and C. H. Stewart.



PUZZLE: FIND CHICAGO

This meeting will last until 6:30 and at 7:30 we will be back hard at it in a technical session devoted to spark transmitting and receiving apparatus, with talks scheduled by Paul F. Godley, M. B. West, J. K. Hewitt, V. M. Bitz, E. S. Rogers, R. H. G. Mathews, E. W. Stone, P. E. Wiggin and Irving Vermilya. If Mr. Stone accepts the invitation, there will also probably be a debate on power factor between him and Mr. West—Oh Boy!

Second Day

The program opens with educational lectures at 10:30 a.m. by Prof. R. V. Achatz of Purdue, Mr. Harvey Mitchell Anthony of Muncie, and Prof. C. M. Jansky of the University of Minnesota.

At 1:30 p.m. there will be a meeting on clubs and their work, their relation to

traffic work, suggestions for their improvement, etc., with addresses by Messrs. Maxim, Schnell, F. Clifford Estey, Hamilton, Stolte, and Bos.

The A.R.R.L. Operating Department will have a general traffic meeting at 3:30 in the afternoon to take action on matters discussed in the general business meeting of the preceding day, with addresses by Traffic Manager Schnell, President Maxim, and all of the A.R.R.L. Division Managers.

At 7:30 we will resume with another technical session, this time devoted to C.W. apparatus, both transmitting and receiving, with talks expected from Dr. Lee deForest, Major E. H. Armstrong, Commander A. Hoyt Taylor, and Messrs. L. M. Clausing, Robt. F. Gowen, Frank Conrad, E. F. W. Alexanderson, and K. B. Warner. Mr. Conrad's talk in particular will be of interest—"The Effect of the Radio Phone on Traffic Work."

Third Day

The third day again opens with educational lectures at 10:30 by Messrs. Kruse and Anthony and Prof. W. Terry of the University of Wisconsin. Mr. Kruse will discuss fading phenomena and give us some first-hand dope on the A.R.R.L.—B.S. co-operative tests.

Now for a little fun: at 1:00 p.m. there will be an indoor baseball game between the A.R.R.L. Board of Direction and the Chicago Executive Council, each player wearing his call letters in large letters on a placard on his back. Matty promises a compressed air whistle, controlled by a key, to pull off some "razzing" in Continental.

If our Board of Direction is able to walk after the game, they will have an executive session for the formal transaction of League business from 3 to 7 p.m.

And for the rest of the night we have engaged one of Chicago's best cabarets for a real get-together, all for fun and with no speeches whatever. Watch out here for T.O.M. and his Wouff-Hong! And possibly here will be the Liar's Contest—if anybody will be able to make himself heard.

Last Day

Again at 10:30 the day starts off with lectures by Mr. Anthony and by Mr. J. H. Miller, of the Jewell Electrical Instrument Co.

From 2 to 5 p.m. a Stunt Party will be held, with many novel and interesting tests for which valuable prizes will be awarded.

And at 8 p.m. the biggest banquet ever held in the history of Amateur Radio, at the Edgewater Beach Hotel on the famous beach walk, with short addresses via Magnavox from gondolas on the lake. Dancing too, and counting noses for various clubs represented, and the introduction of prominent fists.

How Does That Sound?

Isn't that a program to make a fellow put his transformer in hock to get there? You tell 'em, Bessey, I'm too Busy! There will be not several hundred present, but several thousand. Reservations are pouring in, and we honestly have three hotels lined up to take care of the crowd, with special rates for us radio men.

Each morning there will be automobile and motor-bus tours over the city, with yacht and motor-boat rides on the lake, and hydroaeroplane trips, swimming, tennis and golf facilities available on the hotel grounds—so that it will not be all work and no play bianimeans. In fact, here's the chance of a lifetime to combine a peach of a vacation with all the radio you can soak in.

Special Railroad Rates

Here is some good news. The railroads have special fares for large conventions and we have succeeded in making arrangements whereby a rate of one and a half times the one-way fare will apply for the round trip for all visitors except from the west coast, from which territory the arrangement does not apply. This will save one-fourth on transportation! The following should be carefully observed:

The reduced fare applies for delegates and members and their dependents, for "going" tickets purchased not earlier than Aug. 26th and not later than Sept. 1st. A ticket to Chicago should be purchased at the regular rate, *but be sure to secure from your ticket agent a "certificate-receipt" at the time of purchase.* This is important, as on Sept. 2d and 3d there will be a special agent of the railroads present at the convention who will countersign this form after it is certified by Mr. R. H. G. Mathews, our representative for the purpose, and upon surrender of this certificate at any ticket window a return ticket will be issued for *one-half* the regular fare to your home. Return tickets must be purchased by September 7th.

The Radio Show

The Broadway Armory, the most modern and largest exhibition hall in Chicago, just a few blocks from the three convention hotels, has been secured for a radio exhibit that will skin the world. You will see here the best that our manufacturers have to offer, and this show alone will be well worth the trip to Chicago. You who are planning bigger and better stations for next fall (and who among us isn't?) will have the chance to see the actual apparatus, to compare different makes, and to place your orders on the spot. This exhibit is being planned on a huge scale and in beauty and splendor will equal the successful automobile shows which have preceded it at the Armory. Space is going

rapidly and interested manufacturers should communicate at once with the show director, Mr. N. E. Wunderlich, 4533 No. Sawyer Ave., Chicago.

Q S T Musicians

An orchestra of radio men is being organized to furnish entertainment. The organizers desire to hear from every radio bug who can acceptably play any musical instrument, especially wind instruments. Cello and base-viol are also needed. Parodies on popular songs are solicited. Orchestrations on the music selected will be sent free of charge. It is preferable that the members of the orchestra be present on the 30th if possible, altho this is not essential. Those interested will please communicate with 9PQ or 9SA, who will furnish further information.

Police Co-operation

At the general business meeting on Aug. 30th attention will be given the matter of co-operation with police departments in the recovery of stolen autos by amateur broadcasts relating thereto and to other police matters. We want the police folks from cities who are interested in this work to be present and hear the discussions and gain an idea of what we can do for them. To this end, will every A.R.R.L. member see that his police officials are informed of this opportunity to see for themselves the

possibilities of accepting amateur co-operation in their work?

The Ladies

We want them—bring 'em along, they'll enjoy every minute of their stay. Visitors will be met at incoming trains by auto or bus and special arrangements are being made for the ladies' accommodation, the plans including shopping tours thru the various stores, automobile and lake trips, etc., under the kindly pilotage of the Chicago O.W.'s.

How to Get There

Now O.M., we've made this thing so fine, done it up in such apple-pie A.R.R.L. style, that we know you'll admit with us that you just have to go. Our dream of years is about to be realized—our whole big A.R.R.L. is going to get together—officers, directors, traffic officials, relaying stations, and general membership. From the four corners of Canada and the U.S. we'll be there, to greet each other, to swap yarns, to clasp the hand that theretofore has been heard but never seen, and we're going to have four big days of it. Don't you dare to miss the First National A.R.R.L. Convention. The thing to do is to sit right down and dash off your reservation to Mr. N. C. Bos, Reservation Manager, 118 No. LaSalle St., Chicago, and tell him just what you want.

CU QSA Chicago, OM!

Modulation in Radio Telephony*

By R. A. Heising

In Two Parts: Part II.
Constant Current System

The most desirable circuit for most amateurs to use is the constant current system. This has been described in numerous papers but is indicated again in Figure 10. It consists essentially of an oscillator and a modulator tube being supplied in parallel from a constant current source. The constant current source needs to be of constant current only as regards the signalling frequency, and then, does not have to be exactly so, but merely relative. The simplest arrangement is indicated as consisting of a constant potential generator with a large choke coil in series. Any variation of current through the generator and choke coil at the signal frequency is enormously opposed by the large choke coil, so that if a signal is impressed upon the grid of the modulator tube causing the current taken by it to vary, the variation must pass through the oscillator for the reason that the large choke coil imposes such a large impedance to any variation in current through the generator that the variable current is forced through the oscillator.

This causes the oscillator to deliver an antenna current which varies according to the power supply.

The behavior of the constant current system is represented in Figure 11. The modulator has such a negative voltage that its space current is about the same as that of the oscillator. Theoretically they should be exactly the same but practically the modulator can be adjusted to take one half the space current of the oscillator when not signalling and on account of the curvature of the tube's characteristic, it will rise to an equal value while signalling. In curve I they are represented as equal. The top horizontal line represents the total space current which is kept constant. As the signal is impressed upon the modulator grid, the current taken by it varies according to the distance between the curved line and the top horizontal line, forcing the oscillator to take the remainder of the current—that represented by the ordinates of the curved line—from the bottom horizontal line. Now the voltage necessary to force this varying current through the oscillator must vary also, and it happens to vary in a corresponding manner, having the form shown in curve II. The antenna

*Presented at Radio Club of America Columbia University, Feb. 25, 1921.

current amplitude is proportional to the oscillator voltage or to the oscillator current and will also vary in a corresponding manner as shown in curve III. We thus get in the antenna a h.f. current whose amplitude varies according to the signal to be transmitted.

any power is lost there. Thus at the two extremes of maximum and minimum antenna current, the modulator dissipates no power, and the average while transmitting a completely modulated signal is one half the non-signaling amount wasted.

A desirable feature of this system is that no further changes or adjustments are necessary to the oscillator after tuning it up properly. The modulator is not part of the high frequency circuit and upon completing the high frequency adjustments, the system is ready to work.

It must be remembered, however, that the modulator has its own adjustment—that of the negative grid potential—but this adjustment is independent of the high frequency circuit.

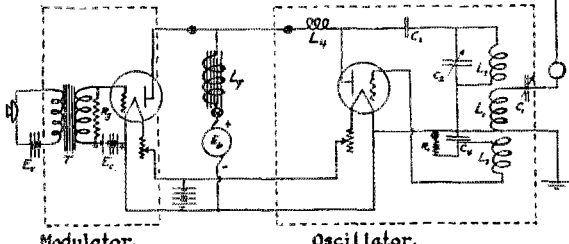

FIG. 10 200 Meter Constant Current Transmitter

The reason for the rise in voltage at point X to twice the generator voltage is explained by the fact that the constant current choke coil acts as a storehouse for energy at times and delivers this energy back at other times. Thus at point Y curve II the voltage across the oscillator and modulator is practically zero because the modulator resistance has dropped and the choke coil has such a large reactance against an increase in current that most of the generator voltage, if not all, is taken up by it. During this period, the choke coil stores up energy being delivered by the B battery. At other instants such as X, the modulator resistance has gone to infinity and the choke coil now delivers up this stored energy and causes the voltage across the oscillator to rise to twice the normal value.

This system can be used with any type of oscillator, or with certain master-oscillator-controlled amplifiers. The principal precautions to be observed are to see that the high frequency and audio frequency circuits have proper condensers or choke coils in them to pass the desired currents and stop the undesired ones.

Master Oscillator Systems

Each system so far described has certain advantages and disadvantages as com-

The variation of power to the oscillator is represented in curve IV. This curve is arrived at by multiplying curve I by curve II. An interesting fact to be observed is that at point X the power being delivered to the oscillator is twice the average being delivered by the B battery. This is accounted for by the fact previously mentioned of the choke coil storing up energy during part of the signal cycle (around point Y) and delivering up this energy at another time. It causes the constant current system to be one of the most efficient circuits that has been devised.

Curve V represents the power delivered to the modulator. The power lost there is a maximum under the non-signaling condition. At point X when all the current goes to the oscillator and none to the modulator, the power dissipated in the modulator is zero. At point Y when all the current goes to the modulator and none to the oscillator, the voltage across the modulator is so small that again scarcely

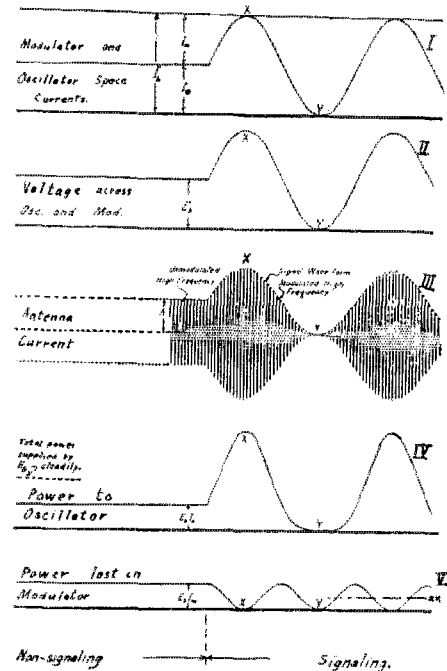

FIG. 11 Constant Current System Behavior Curves.

pared to the others. The Van der Bijl system is what may be termed a "master oscillator system": that is, the frequency is set by a separate oscillator circuit and not by the antenna circuit. The Modulating Amplifier also has this advantage. The frequency in these circuits is thus not dependent upon variations in antenna capacity, something which varies considerably in a rolling vessel, and sometimes with weather in a land station. The constant current system has its own advantages and it would appear quite desirable to have a system which had the advantages of all. Such an arrangement is shown in Figure 12. In this circuit, the frequency is set by the oscillation circuit L_1C_1 of the master

circuit shown in Figure 13 when used on short waves.

Voltage At Which Systems Must Operate

A question of importance to the amateur is "what voltage must I operate at, or what system should I use if I have power at a certain voltage available." This brings out the fact that the minimum voltage at which a given kind of a tube can be operated to give the rated power varies with the system. If we assume the same plate circuit efficiencies in the constant current system oscillator, the modulating-amplifier system amplifier, and the Van der Bijl system amplifier, and have an adjustment which will give maximum power while sig-

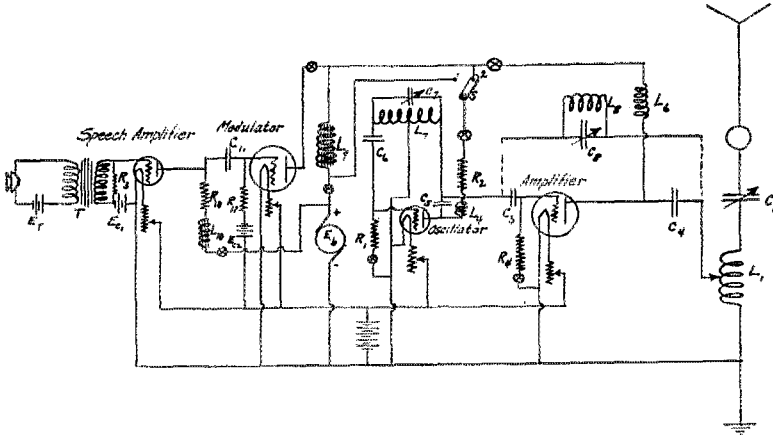

FIG. 12 - Current Modulation of Separately Excited Amplifier.

oscillator. The plate current supply to the amplifier alone, or to both the amplifier and the oscillator, is modulated by the constant current system. The desirable reasons for modulating the power supply to both oscillator and amplifier are given in detail in my paper delivered before the Institute of Radio Engineers on December 1st 1920. Very good results are obtained if only the amplifier is modulated.

In using this arrangement or any other master oscillator arrangement the amateur may find that a considerable amount of power from the oscillator goes directly through the grid-plate capacity of the amplifier into the antenna, and the frequency of the oscillator is not independent of the antenna tuning. This is especially the case at short waves. To eliminate this trouble, the grid-plate capacity of the amplifier should be "anti-resonated" at the carrier frequency by placing a parallel tuned circuit across the grid-to-plate terminals and adjusting the capacity (C_5 in figure 12) until the minimum power goes through. This anti-resonant circuit is also desirable in the modulating-amplifier cir-

cu-lling, it will be found that the relative voltages necessary for getting the same amount of modulated power from the same number of tubes is:

- Constant Current System.....E
- Modulating Amplifier System..... $E \sqrt{2}$
- Van der Bijl and all Amplifier Systems..... $E \sqrt{2}$

This means that if two tubes capable of giving 50 watts each at 750 volts in an oscillator circuit adjusted for maximum power are to be used in the modulating amplifier system, or as the last amplifier stage in any amplifier system where a small amount of power is first modulated and then amplified, a voltage of $\sqrt{2} \times 750$ or 1061 must be used on both tubes in parallel as amplifiers to get the same modulated high frequency current into the antenna that THEY will give if used on 750 volts in the constant current system (one as oscillator and one as modulator). The reason for this difference is pointed out below.

Suppose you have two tubes capable of delivering 50 watts each at 750 volts with

a plate circuit efficiency of 60% whether used as oscillator or amplifier. If used in the constant current system the non-signalling condition of the oscillator is:

| E_b | I_b | Power in | H. F. Power |
|-------|-------|-----------|-------------|
| 750 | .1104 | 83 1/3 w. | 50 w. |

At the instant of delivering maximum power to the antenna, (X in curve III, Figure 11) the total oscillator and modulator space currents are forced through the oscillator alone at double the average plate voltage (X in curves I and II, Figure 11) or

| E_b | I_b | Power in | H. F. Power |
|-------|-------|------------|-------------|
| 1500 | .2208 | 333 1/3 w. | 200 w. |

which is four times the normal power. Any system to deliver this same modulated H. F. power (50 watts non-signalling and

give the peak value of 200 watts, and cannot cause the same modulated power to be delivered to the antenna. These two tubes together take at a maximum only the same space current that the signal tube as oscillator in the constant current system takes at the maximum point, and also have only 750 volts at that instant while the oscillator has 1500. To make the two tubes as amplifiers give 200 watts maximum, the plate voltage must be raised to $\sqrt{2} \times 750$, at which time they will take a space current of $\sqrt{2} \times .2208$ or a power of $2 \times 166 \frac{2}{3}$ w. and will give out $2 \times 100 = 200$ watts. This is then the maximum power condition:

| E_b | I_b | Power in | H. F. Power |
|-------|-------|------------|-------------|
| 1061 | .312 | 333 1/3 w. | 200 w. |

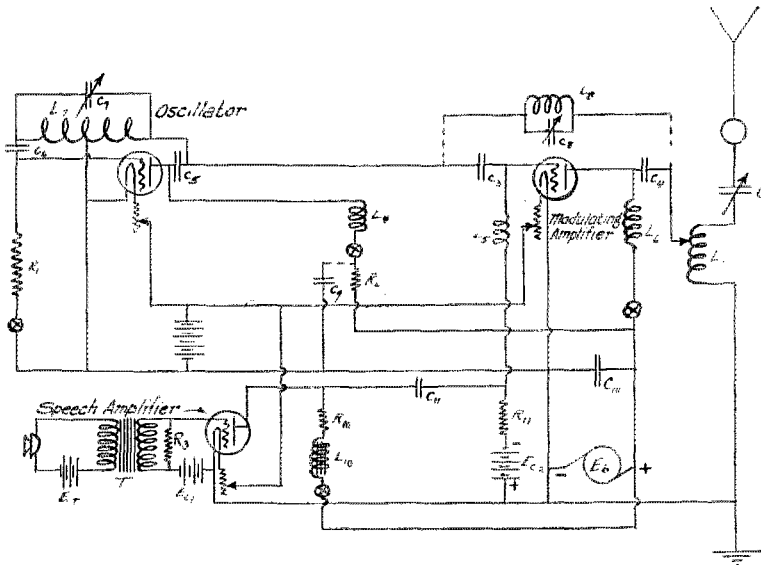

FIG. 13~ 200 Meter Modulating Amplifier Transmitter.

200 watts maximum while signalling) must be capable at some instant of delivering 200 watts by some adjustment and this adjustment must be one which can be operated by the speech signal.

If the two tubes are used in parallel as amplifiers, instead of being used one as oscillator and one as modulator, the two of them together will give

| E_b | I_b | Power in | H. F. Power |
|-------|-------|------------|-------------|
| 750 | .2208 | 166 2/3 w. | 100 w. |

This is their maximum power adjustment, and NO ADJUSTMENT IS POSSIBLE THAT WILL MAKE THEM GIVE MORE. A signal operating upon the grid therefore cannot cause the two tubes to give more power, and cannot cause them to

The experimenter is here cautioned against thinking the above adjustment is to be maintained. It is merely the maximum power adjustment. The negative voltage of the power tubes must now be increased until the antenna current is one half the maximum to get the non-signalling steady value, the adjustment which he must have when he expects to communicate. The power relations in the circuit then are:

| E_b | I_b | Power in | H. F. Power |
|-------|-------|-----------|-------------|
| 1061 | .156 | 83 1/3 w. | 50 w. |

That is, the system must operate on a plate voltage of $\sqrt{2} E$ and each tube must take a space current of $\frac{I}{\sqrt{2}}$, where E and

SOME TUBE COMBINATIONS AND THE CIRCUITS MOST DESIRABLE TO USE.

| No. | Tubes | Circuit | Master Oscillator | H.F. Amp. | Speech Amp. | Antenna Oscillator | Modulator | Plate Voltage | Order of Desirability |
|-----|--------------------------|--------------------|-------------------|-----------|-------------|--------------------|--------------|---------------|-----------------------|
| 1. | 1-5 Watt | Fig. 5 | | | | 5 W | | 300 | 6 |
| 2. | 2-5 W | Fig. 10 | | | | 5 W | 5 W | 300 | 3 |
| 3. | 1-5 W 1-50 W | Fig. 8 | 5 W | 50 W | | | | 750-1000 | 5 |
| 4. | 2-5 W 1-50 W | Fig. 13 | 5 W | 50 W | 5 W | | | 750-1200 | 3 |
| 5. | 1-1 W 1-5 W 1-50 W | Fig. 13 | 5 W | 50 W | 1 W | | | 750-1200 | 3 |
| 6. | 2-50 W | Fig. 10 | | | | 50 W | 50 W | 750 | 4 |
| 7. | 1-1 W 2-50 W | Fig. 14 | | | 1 W | 50 W | 50 W | 750 | 3 |
| 8. | 1-5 W 2-50 W | Fig. 14 | | | 5 W | 50 W | 50 W | 750 | 2 |
| 9. | 1-1 W 1-5 W 2-50 W | Fig. 12 | 5 W | 50 W | 1 W | | 50 W | 750 | 2 |
| 10. | 2-5 W 2-50 W | Fig. 12 | 5 W | 50 W | 5 W | | 50 W | 750 | 1.5 |
| 11. | 1-5 W 3-50 W | Fig. 14 | | | 5 W | 50 W | 2-50 W | 750 | 1 |
| 12. | 2-5 W 3-50 W | Fig. 12 | 5 W | 50 W | 5 W | | 2-50 W | 750 | 1 |
| 13. | 3-5 W | Fig. 10 Fig. 14 | | | 5 W | 5 W | 2-5 W 5 W | 300 | 2 |
| 14. | 1-1 W 3-5 W | Fig. 14 | | | 1 W | 5 W | 2-5 W | 300 | 1 |

E are the generator voltage and the current per tube, respectively, for the constant current system.

The above mentioned ratio of voltage required for constant current and amplifier systems does not hold if the adjustment when used in the constant current system is not for maximum power but for something less. That is, if the same two tubes

are used on say, 1200 volts to give 50 watts h.f. from one as oscillator, it is obvious that the adjustment is not for maximum power since 50 watts can be obtained at 750 volts. If the two are now used as amplifiers, they will give the required 200 watts maximum at 1200 volts without any trouble at a different adjustment.

(Concluded on second following page.)

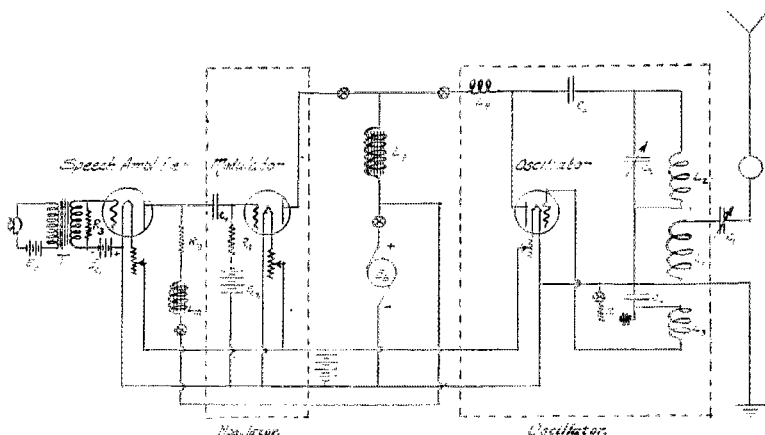

FIG. 14 - 200 Watt Constant Current Transmitter

TYPICAL CONSTANTS FOR CIRCUITS

These constants are for a 200 meter set on an antenna of .0006 mf. capacity, resistance of 15 ohms, and free period of 300 meters. Tubes are rated as 5 Watt on 300 Volts and 50 Watt on 750 Volts. (T.F. 5 W means tungsten filament 5 watt tubes, C. F. 50 W means Coated filament 50 Watt tubes, etc.)

| Element | Description | Circuits Used In |
|-------------------------------|---|---------------------------|
| L_1 | .038 mh. (5 W tubes) 14 turns #22 TCCC on 4 $\frac{5}{8}$ " tubing | Figures 10 and 14 |
| | .026 mh. (50 W tubes) 9 turns #22 TCCC on 4 $\frac{5}{8}$ " tubing | |
| | .035 mh. 30 turns #22 TCCC on 2 inch tubing. Tap each turn for coupling. | |
| L_2 | For 5 W tubes same as L_1 For T.F. 50 W—.04 mh.—12-T #22 TCCC on 4 $\frac{5}{8}$ " For C.F. 50 W—.021 mh.—8-T #22 TCCC on 4 $\frac{5}{8}$ " | Figures 10 and 14 |
| L_3 | T.F. 5 W—.056 mh.—15-T #24 DCCC on 4 $\frac{5}{8}$ " C.F. 5 W—.027 mh.—10-T #24 DCCC on 4 $\frac{5}{8}$ " T.F. 50 W—.036 mh.—11-T #22 TCCC on 4 $\frac{5}{8}$ " C.F. 50 W—.008 mh.—5-T #22 TCCC on 4 $\frac{5}{8}$ " | Figures 10 and 14 |
| L_4 | 3 mh. (type 67-A) choke coil | Figures 10, 12, 13 and 14 |
| L_5 | 3 mh. (type 67-A) choke coil | Figure 13 |
| L_6 | 6mh. (two type 67-A choke coils) | Figures 12 and 13 |
| L_7 } | each .075 mh.—40-T #22 TCCC on 2 $\frac{1}{2}$ " tubing or 44-T 81 strand #38 SCCC on 2 $\frac{1}{2}$ " tubing | Figures 12 and 13 |
| L_8 } | | |
| L_9 | With 5 W tubes 1 Henry (type 54-D) With 50 W tubes 2 Henrys (two type 64-B) | Figures 10, 12 and 14 |
| L_{10} | 5 Henrys or more. Not essential if E_b is large and R_{10} is 10000 ohms or more. | Figures 12, 13 and 14 |
| C_1 | .0 to .000175 mf. variable. If 50 W tubes are used it must stand considerable voltage. | Figures 10, 12, 13 and 14 |
| C_2 | .0 to .000150 mf. variable for 5 W tubes. .0 to .0005 for 50 W tubes and must stand considerable voltage. | Figures 10 and 14 |
| $C_3=C_4$ | Fixed condenser. Any value between .0005 and .01 mf. | Figures 10, 12, 13 and 14 |
| $C_5=C_6$ | Same as C_2 | Figures 12 and 13 |
| $C_7=C_8$ | 0 to .000150 variable | Figures 12 and 13 |
| C_9 | 1 mf. or larger. Not essential to the circuit but aids modulation some. | Figure 13 |
| C_{10} | 1 to 10 mf., preferably 10 mf. 22-AA type | Figure 13 |
| C_{11} | 1 mf. | Figures 12 and 13 |
| R_1 | 12,000 ohms if on a 5 W oscillator 6,000 ohms if on a 50 W oscillator | Figures 10, 12, 13 and 14 |
| R_2 | Sufficient to reduce voltage across oscillator to the desired value. | Figures 12 and 13 |
| R_3 | $\frac{1}{2}$ megohm or over with 1 or 5 W tube. 50,000 if on 50 W tube. | Figures 10, 12, 13 and 14 |
| R_4 | 6000 ohms for 1-50 W tube h.f. amplifier 3000 ohms for 2-50 W tube h.f. amplifier | Figure 12 |
| R_{10} | Sufficient to reduce voltage across speech amplifier to the desired value. | Figures 12, 13 and 14 |
| R_{11} | 10,000 to 20,000 ohms | Figures 12, 13 and 14 |
| T | 50 to 750,000 impedance ratio for 5 W (201-C) 50 to 50,000 impedance ratio for 50 W (201-J) | Figures 10, 12, 13 and 14 |
| E_t | 3 dry cells | Figures 10, 12, 13 and 14 |
| E_{c_1} and E_{c_2} | 22.5 volts for 5 W tube 30 volts for 50 W tube | Figures 10, 12, 13 and 14 |

Systems The Amateur Can Use

The system an amateur should use depends considerably upon the types and number of audions he has available. Some of the combinations to be considered are given in this table together with the uses of the tubes. In the list, the 5 watt tube may be a Western Electric Type E (VT-2) or G.E. VT-14, and the 1 watt tube a Western Electric Type J (VT-1).

By "desirableness" is meant desirableness from the point of view of tube arrangement only. It does not take into consideration the different voltages nor the constancy of frequency.

Following are the additional diagrams (Figures 13 and 14) referred to in the list

with some of the constants for the parts of the circuit. These constants must not be taken as exactly correct because the antennae used by amateurs vary so widely. The values given are for a 200 meter set on an antenna of .0006 mf. capacity, 15 ohms resistance, and a free period of 300 meters. In the sets where the oscillator works directly on the antenna, the oscillator circuit most desirable is the one shown—Aker's modification of the Meissner circuit. It is better for a high resistance antenna at short waves than the Colpitts oscillator. If the antenna should have a low resistance around 6 ohms or the wave length be longer than 200 meters, the Colpitts oscillator will work as well and possibly be easier to adjust.

A Dream

By The Old Boy

THE rain was lapping on the pane, the wind moaned faintly without. By straining ear and imagination, I could faintly decipher some phone music 'neath the rasping squawk of the flivver coils and the grunting roars of the big bugs. Way up in C minor, some sap was playing a ditty with a cootie key, and the ham next door was just asking the seventeenth patient op. (I counted 'em) how wuz his sigs. Nothing on the pin, nothing to do, so I sprawled out in my easy chair, and gradually committed myself to Morpheus' care.

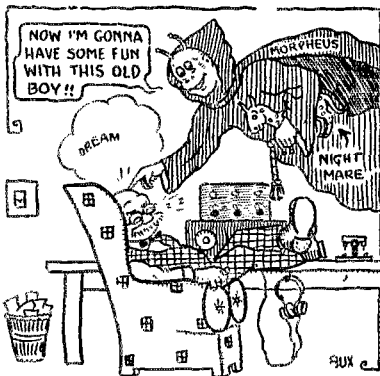

I was in the street. To and fro people were scurrying, and to my amazement each cuckoo wore a set of Chelsea "Muds", to which was attached a complete receiver, the whole set measuring ten cubic inches in all. All wore tall plug hats, which reminded me of a picture of some old Solomon reposing serenely among the garret's dust. Later I discovered that the hats contained small loops of about thirteen hundred

turns of No. 76 bare carbon wire, which furnished the antenna system for these sets. As I wandered along, I came to a building into which the masses were flocking. Stopping a pedestrian, I chirped: "What's the great attraction, circus or 10th District Exposition?"

Removing one fone, he favored me with a blank stare, and grunted: "Dit-dit-dit-dit-dit-dit-dit-dit-dit-dit dit-dit-dah-dah-de-dit."

Whereupon two facts penetrated my wool: (1) that Morse was the language in which these cuckoos jammed each other, and (2) that this individual cuckoo had asked me "huh?" Turning my quiz into Morse, I made myself understood, and learned that a great trial was going on within.

Following my informer, I entered a large room, in which hundreds of people were crowded, all "ditting" and "dahing" at a phenomenal rate. Presently a hush was heard to fall upon the audience, a door opened, and a venerable old cuss entered, and sat down behind the desk. 'Twas T.O.M. On one shoulder perched ye cat, he carried ye Wouff Hong and Rettysnitch, and was puffing away at ye old corncob with all the vigor noticeable in his "rotten" stories. As he seated himself a crier arose, and announced the purpose of the court in Morse, at about 260 words per minute, which I copied easily, although I never have done better than fifty-five consciously, or fifty-six unconsciously.

"Congregated Hams of the Universe", he chirped, "we are here today to try several dumb-bells convicted of QRming".

Then he called out a name. A youth was dragged forward, and the charge was read; i.e., of sitting on a key after fourteen A.M. on the evening of April 31, 1954.

After much discussion T.O.M. arose, and in the midst of a tense silence, handed the Wouff-Hong to the Sergeant-at Arms, and the prisoner was dragged out. When his

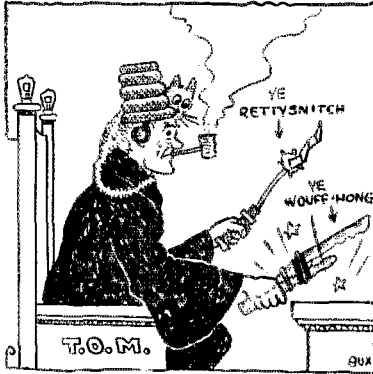

screams had ceased, the court resumed business. The next case was a QRMer on 35 KW., who was tried and sentenced to the Rettysnitch.

The next victim was the Young Squirt. As he stood before T.O.M. he shrieked, "Curses on you, you profligatious son-of-a-gun, I hope you choke!"

T.O.M. scowled benevolently, and hissed: "Squirt, ol' deah, you'd better sine off now, for never again shalt thou call thy venerable father names." Then to the Sergeant-at-Arms, "To the Arc Furnace!"

As the Y.S. was led away he turned and shouted, "You blamed old corn-cob chewer, here's hoping the ham next door puts a book on his key when you're trying to work 6XYZ!"

Then a crier arose and called another

name. Eyes were focused on me, I was seized and dragged before T.O.M. Giving me the malevolent O.O., he read the charge: "You, T.O.B., are accused of causing QRM on 3501 KW. and 16 centimeters with a Century buzzer, and are sentenced to be electrocuted."

Dumbly I stood there, then a guard stepped forth and dragged me out. We went into another room, and I was strapped into a chair. Suddenly the guard pushed a switch, there was an awful roar, and I found myself being used as fuel by a current of about 600000 amperes, more or less.

I awoke to find myself sitting on the key, holding on to the secondary terminals of the fivver coil, and hollering for help. I quickly changed my position, and relit my

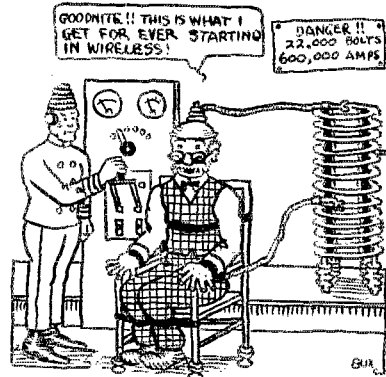

bulb, returning to the faint strains of music, the QRMING ham on the next corner, and the 2 KW. bug, mentally vowing to tune that transmitter NOW.

Spark Reception on Honeycombs

By Chas. Kinyon

In Two Parts: Part II.

The adjustment I speak of may be obtained in the following manner: select a primary coil of such size that the desired wave length will be obtained with the primary condenser set at about 10 to 40 degrees when placed in multiple and from 140 to 180 degrees when used in series with the primary coil. Other settings of this condenser can of course be used if necessary but the settings mentioned seem to me to give slightly louder signals and easier adjustment.

The secondary shunt condenser should be as near to zero value as possible and still get the wavelength desired. This usually means use L-35 coil for 200 meters and L-100 for 600 meters, although the

coils vary somewhat in inductance and other parts of the set may cause different coils to work better. The value of the capacity of the grid condenser does not seem to be very critical but in general I get better results by using greatest capacity with short waves and smaller capacity with the longer wave lengths. The grid leak is connected from grid to filament and adjusted to the greatest resistance which will prevent the tube from producing a continuous clicking sound.

Select a tickler coil of suitable size (size will vary with individual bulbs) so that very close coupling will have to be used to cause the tube to oscillate when the secondary condenser is set on zero and the

plate condenser near minimum amount. It is well to leave a little margin to adjust to closer coupling and lower plate capacity if necessary.

Having determined what coils to use turn the tickler at right angles to the secondary or better yet short it out and adjust "B" battery potential and filament current to a point just below where the hissing sound is produced or where the circuit gets rather noisy. Then turn the tickler coil back to approximately 30 to 45 degrees with the secondary and very likely the bulb will again become noisy. If it does not do so try different adjustments of the primary condenser or the secondary condenser and plate condenser until it does become noisy and sounds like it ordinarily would with too high a filament current. At times it may also be necessary to try different degrees of coupling between the primary and secondary or the secondary and tickler. With the bulb in this comparatively noisy condition then try varying the primary or secondary condenser separately until the bulb goes quiet again. When the proper adjustment is reached you will find that by turning either primary or secondary condensers one or two degrees in either direction the bulb may again be made noisy but between these points the bulb is quiet except for ordinary static. When in this position the bulb is unusually sensitive to spark signals and brings them in with no more distortion of the natural note than is noticed in a regenerative set. Signals may be heard quite loudly which are entirely inaudible by the ordinary method of adjustment. Signals from a still farther distance may be read by throwing either the primary or the secondary condensers very slightly to either side but they then come in with a mushy note characteristic of the regular oscillating tube and at times with some tubes the noise of the tube may become so loud as to resemble bad static and prevent the signals being read. This quiet spot may be moved from point to point on the condenser scale of the primary and secondary condensers and so varied to different wave lengths and different stations picked up. This arrangement greatly increases the selectivity of the set as it apparently cuts down the signal strength of stations not coming in on the quiet spot as much as it increases the strength of those that do come in there.

When changing from one wave length to another several perplexing situations may develop, as for instance, if you are properly adjusted with the primary and secondary condensers both on 40 degrees and find that turning either condenser 2 degrees in either direction causes the bulb to be noisy and you desire to change to a wavelength whose proper setting would be at say 60 degrees on both primary and

secondary condensers, you are quite likely to find that in this position turning either the primary or secondary condenser to 58 degrees will make the bulb noisy but that turning the condensers any distance over 60 degrees will not do so. This condition indicates that the tickler coil is too far from the secondary or that the plate condenser has too little capacity and may be remedied by more capacity in the plate condenser or by closer coupling of the tickler coil.

Again if you were to change from a proper adjustment at 40 degrees to one say at 20 degrees you are likely to find that by turning either condenser to 22 degrees the bulb will become noisy but that by turning them in the other direction any distance down to zero they will not make the bulb noisy. This indicates that too much capacity is being used in the plate condenser. The remedy is obvious.

Another situation which may be somewhat confusing at first occurs at times when the noisy spots can be found on both sides of the correct setting but are separated too far to give good results. For instance assume that the wave you desire to receive adjusts to 40 degrees on both primary and secondary condensers but that when either primary or secondary condensers are varied they can be turned to 60 degrees or to 20 degrees before the bulb goes noisy. This condition leaves the station readable if he is loud but if weak you may not even hear him at all. It can be corrected and the noisy spots brought close together by increasing the separation between the primary and secondary (decreasing the coupling) or by bringing the tickler coil closer to the secondary or increasing the capacity of the plate condenser or by adjusting all of them some. I frequently bring in stations very loud, which I was not able to hear at all before making the adjustment, by merely increasing the coupling of the primary and secondary.

Another condition sometimes arises where the noisy spot occurs right on the desired wave length and there is only one noisy spot. This indicates that the primary coil is separated too far from the secondary coil or the tickler coil is too close to the secondary coil or too much capacity is in use in the plate condenser. Improper adjustment of the filament current may also cause either of the above cases but is much less likely to do so than the causes mentioned.

This adjustment cannot be used for arc reception as the necessary heterodyne beats are not obtained, at least at audible frequency, and one condenser or the other must be turned to one side or the other of this point to bring the arcs in.

(Continued on page 30)

Quiet Hours for Listening for DX

By The Traffic Manager

FELLOWS, with your help we are going to have "quiet hours". The spontaneous endorsement of The Old Man's suggestion which appeared in June QST, page 25, has prompted The Operating Department to adopt the scheme in the hope that we may hang up some new records. The Old Man thinks that some of the Pacific Coast stations can be heard on the Atlantic Coast and vice versa, and we have come to the same conclusion and are firmly of the opinion that

Section C will QRX

Tuesday 1:00 A.M. to 2:00 A.M. E.S.T.
 Thursday 1:00 A.M. to 2:00 A.M. E.S.T.
 Saturday 12:01 A.M. to 1:00 A.M. E.S.T.

When the time comes for the section in which you are located to QRX it means that you should stop transmitting immediately, respecting the rights of other amateurs and showing the true A.R.R.L. spirit of good sportsmanship and co-operation by keeping your transmitter silent during your QRX period. Remember

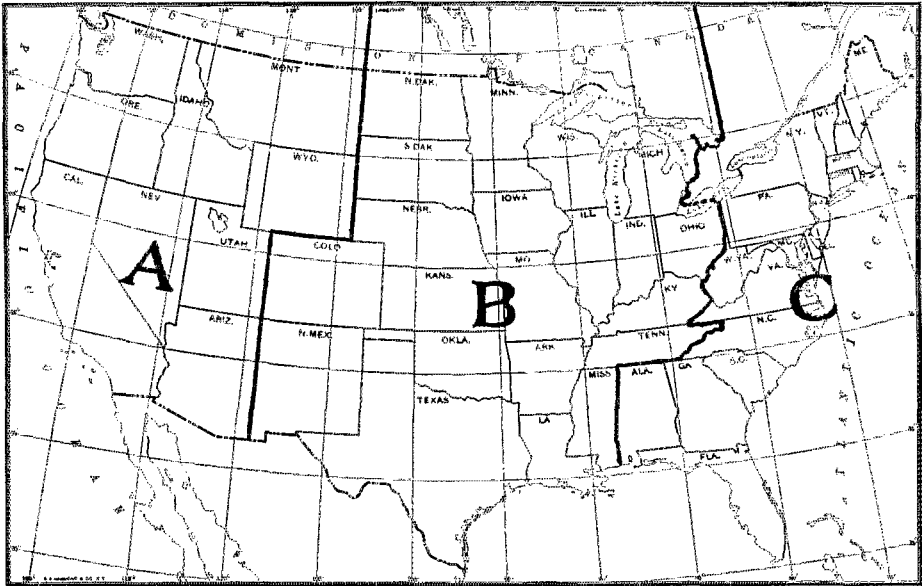

this winter will see many of our stations reaching from coast to coast during the quiet hours.

As the easiest method of putting the scheme into effect, we have divided the country into three zones, as per the appended map, and formulated the following schedule to apply thereon. For convenience's sake these figures are all in Eastern Standard Time. Central Time is one hour earlier, Rocky Mountain Time two hours earlier, and Pacific Time three hours earlier than the figures show.

Section A will QRX

Tuesday 12:01 A.M. to 1:00 A.M. E.S.T.
 Thursday 1:00 A.M. to 2:00 A.M. E.S.T.
 Saturday 1:00 A.M. to 2:00 A.M. E.S.T.

Section B will QRX

Tuesday 1:00 A.M. to 2:00 A.M. E.S.T.
 Thursday 12:01 A.M. to 1:00 A.M. E.S.T.
 Saturday 1:00 A.M. to 2:00 A.M. E.S.T.

you have the same chance of being heard when you are transmitting and the others are QRX-ing, and surely you would not like to have your record spoiled by others QRM-ing just as you were signing off.

The adoption of this schedule does not mean that you are to sit on your key for hours at a stretch calling "CQ" while other sections are standing by, or that you are to give up handling traffic in any sense of the word. When you are not on your quiet hour, go right on with your traffic in the customary manner and the listening stations will do the rest—we do not want to interfere with message handling and no interference will be experienced if everyone does his part.

One very important thing to remember is to keep a log—not only of what you hear but of every transmission of your own station, with the exact time. This is es-

sential if we are to verify reports to the satisfaction of all concerned. We can and will make some wonderful records but we will have to be able to verify them before we start crowing. In the best amateur stations you will find a complete log. Be one of the best amateurs—keep a complete log. And when you make a record that

seems worthy of mention, send it to QST for publication.

Once more: *we cannot have quiet hours unless you want them.* If you want them, as replies to T.O.M.'s suggestion indicate, you will observe the schedule and help your fellow amateurs to do the same.

Our Board of Direction

MANY of our members will be curious to learn what a meeting of our A.R. R.L. Board of Direction looks like. The photograph below was taken at a meeting in early June at the Engineers' Club, New York City. Left to right we see S. Kruse, H. L. Stanley, V. F. Camp, J. O. Smith, Traffic Manager F. H. Schnell, President H. P. Maxim,

which are read at the meetings. At a meeting held in St. Louis during the December convention nearly all of those absent in this photograph were present, and in the meeting scheduled to take place during the coming National Convention at Chicago we expect all of our little official family will get together.

The meetings of our Board are interest-



Secretary K. B. Warner, Treasurer A. A. Hebert, and Chas. H. Stewart.

The particular reason for having this photograph made was that this was Mr. Smith's last meeting with us, his resignation having been made necessary, in accordance with our Constitution, by his recently-developed connection with the Radio Corporation of America. Mr. Smith was a member of our Board from its early days and in his years of service he has been one of our "strong men". We will miss him, but wish him success in his new work.

Our Directors in the south and west do not often get to our meetings in the east, but they make themselves heard by letters

ing affairs. Our Directors are men who have proved their qualifications in the amateur world and when all of them focus attention on some difficulty that particular problem is quite likely to be speedily solved. Our meetings generally commence about 8 o'clock and run far into the night, and of course one can't expect to get a dozen good amateurs around a table and spend all night talking about business—these men are real amateurs and the amateur spirit doesn't "stay put" very well, with the result that the meeting is in perpetual danger of turning into a ham-fest at the slightest provocation, and indeed it generally so terminates.

Around this same table these elected representatives of our A.R.R.L. membership work out the solution to our amateur difficulties. Here they have had long sessions to determine how we should be governed in legislative trouble, and over

this table every important piece of League business is discussed and settled. Responsibility rests on these men, as representatives of the general membership, and they are aware of it. It is really a fine sight to see Citizen Radio at work.

Amateur Quenched Gap Problems

By H. J. Tyzzer*

SEVERAL articles have recently been published in radio magazines concerning amateur quenched spark transmitters, comparing the merits of the rotary and quenched gaps, and debating upon the high and low note for DX transmission. Many of these articles have been very well written and are well supported by facts. However, the magnitude of the questions under discussion will not permit a hurried statement that one is superior to another. Only a careful study of existing conditions aids in solving

and may assign values to the remainder of the apparatus as he may see fit. Amateurs, however, may be supplied with no less than twenty different types of transformers on power lines which vary considerably. Satisfactory quenched gap operation, therefore, lies entirely with the operator, who must choose his apparatus and adjust it in an intelligent manner. It may seem that such an equipment calling for critical adjustments would not be suitable for amateur use, but it is the author's opinion that the amateur, when supplied

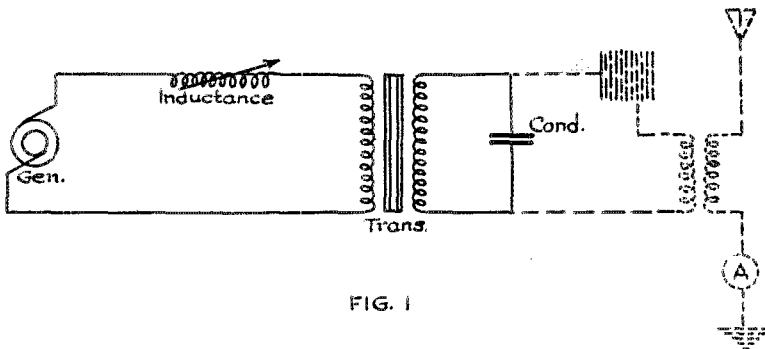

the problems involved. In this paper an attempt has been made to give explanations which will enable the amateur to solve his own particular problem.

If we compare a 500-cycle quenched spark commercial transmitter with a rotary gap outfit of the same power and SPARK FREQUENCY, we find that there is a considerable balance in favor of the quenched set. As a foundation for such a statement, which is far different from the amateur problem mentioned above, a detailed explanation is given of the action of a typical 500-cycle quenched spark transmitter. This may appear as rather far-fetched, but it is absolutely essential that the reader have a clear understanding of the action of such an equipment before undertaking the analysis of the more complicated amateur situation. In the design of a commercial transmitter, the engineer is supplied with definite data regarding generator and transformer characteristics,

with sufficient information, is more ingenious and persistent than the commercial operator, and we find that the regenerative receiver, although quite critical in adjustment, has found much more favor with amateurs because of its increased sensitivity.

In the design of a 500-cycle quenched spark transmitter, the engineer requires the following data: power input, wavelength and antenna capacity.

Let us assume that the values are as follows:

- Frequency.....500 cycles
- Power input.....500 watts
- Wavelength.....200 meters
- Antenna cap......00035 mfd.

A value of primary condenser and secondary voltage must first be chosen. These two factors are co-related by the formula $P = CV^2N$ where P equals the power (500 watts), C equals the primary capacity (to be determined), V equals

*Engineer, American Radio & Research Corpn.

the transformer secondary peak voltage squared (to be determined), and N the frequency in CYCLES (500). It is possible to use a primary capacity as high as .008 mfd. for amateur work, but after applying this to the above formula, we find that the voltage necessary to give the desired power is only of the order of 11,200 peak voltage or 8,000 R.M.S. value. By R.M.S. the root mean square or average value of the voltage is meant, or that which is indicated or measured by a voltmeter. Thus when we speak of 110 volts a.c. we refer to 110 volts R.M.S. value whereas the peak or maximum value is 1.41 times the R.M.S. value, which on a 110-volt a.c. line would be 155 volts peak.

It has been found that for stable quenched gap action, from 1000 to 1500 volts per gap is most suitable. We can see that with the value of primary capacity chosen above, .008 mfd., we will be limited to 8 or 9 gaps, and furthermore it will be necessary to make our primary leads as short as possible to include sufficient inductance in the primary of the oscillation transformer to give the necessary coupling between the closed and open circuits. It would therefore seem more advisable to choose a lower capacity, preferably .004 mfd., which when applied to the above formula gives us a voltage of 15,800 peak or 11,200 R.M.S., and will enable us to employ additional gaps. We now have a complete set of values to use in the radio circuits, and are prepared to proceed with the design of the low frequency and low voltage circuits. It is here that we become acquainted with a resonance phenomenon which is absolutely essential to quenched gap action, and which is a factor causing considerable trouble in amateur quenched gap operation.

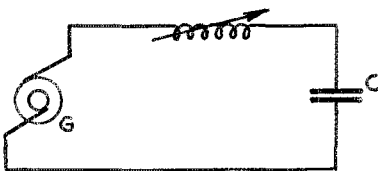

FIG. 2

A thorough explanation of this low frequency phenomenon is very technical, and only that information necessary for successful operation and adjustment of this circuit is given in this paper, the reader being referred to H. E. Halborg's paper in the June 1915 issue of the I.R.E. Proceedings for a more thorough explanation.

A diagram of a simple 500-cycle quenched gap radio transmitter is shown in Fig. 1. Here the radio or high frequency circuits are shown in dotted lines and the audio or low frequency circuits in full lines. Con-

sidering for the moment the low frequency circuit, it is possible to replace, for purposes of analysis, the transformer and condenser by a capacity equal to the transformer turn-ratio squared multiplied by the capacity of the secondary condenser (.004 mfd.). (This statement is true only in case of a non-leakage or non-resonant transformer). Our low frequency circuit is then simplified as shown in Fig. 2. Here

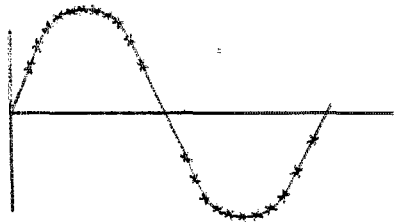

FIG. 3

we have only three elements, the generator G, the capacity C and the variable inductance L.

In an alternating current circuit, we find that a capacity will pass current depending upon the impressed voltage, the size of the condenser, and the frequency of the alternating current. The ability of a capacity to *prevent* the flow of alternating current is dependent therefore on the frequency and the size of the condenser, and is termed "capacity reactance". A very similar condition is encountered when inductance is placed in the circuit, and the quality of an inductance which restricts the current flowing through it is known as its "inductive reactance". Where both of these are present, as in Fig. 2, and where both have the same value of reactance, a condition of resonance is present, which means the effects of the capacity will be counterbalanced by the inductance. Under these conditions the current in the circuit will be limited by resistance only, just as in a d.c. circuit, and abnormally high voltages may appear across both the capacity and inductance. It is now proposed to explain how and why this resonant condition is taken advantage of in a quenched gap radio transmitter.

It requires a much higher voltage to break down a quenched gap at the beginning of a dash, as in telegraphic sending, than to maintain the discharge for the remainder of that dash. This is due to the fact that complete de-ionization of the gap between audio frequency sparks or discharges is practically impossible, and those ions remaining in the gap chamber at the end of the first discharge tend to lower the sparking voltage of the second discharge. If we keep a constant voltage on the gap such as is pictured in the sine

wave, Fig. 3, we find that the gap may break down once during the first alternation and several times in each of the following alternations. *This will give an uneven and rough note which is unsuitable for radio purposes.* However, if we supply what is known as a falling characteristic voltage, that is, a voltage the value of which falls off rapidly as soon as the gap is broken down, this tendency to crowd in extra sparks is eliminated.

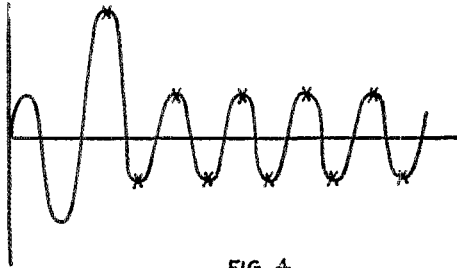

FIG. 4

This is exactly what happens when we resonate our transformer circuit, and voltage such as is shown in Fig. 4 will be present across the condenser terminals. It will be noted that the voltage across the condenser gradually builds up until perhaps at the third alternation it is sufficient to break down the gap. The condenser is then discharged and the voltage must be built up as before, but as the gap has been broken down once, the voltage reached in the first alternation may be sufficient to break it down the second time, and from then on throughout the duration of the dot or dash we have sparks occurring regularly and hence the tone or note is pure. If the total gap is made longer by adding more individual gaps, it may not break down until the fifth alternation as in Fig. 5, and every other alternation following. Under these conditions a half note is obtained which is equivalent to one spark per cycle.

It is hoped that from this the reader understands the importance of the primary or low voltage circuit of the transformer. We are now in a position to tackle the greater problem of successful quenched gap action on 60 cycles under amateur conditions.

The only changes from the 500-cycle problem lie in the frequency and character of the supply, but that is sufficient to alter the design considerably. Assuming the following values as before:

- Power input..... 500 watts
- Frequency..... 60 cycles
- Wavelength..... 200 meters
- Antenna cap..... 0.0035 mfd.

and applying the formula $V = \frac{W}{CN}$, we

find that with a .004 mfd. condenser, our desired voltage will be 32,400 R.M.S., which is exceedingly high for a ½-kw. transformer. It would therefore seem preferable to use .008, in which case our voltage is reduced to 22,800 R.M.S. Now, there are at present no transformers available of ½-kw. capacity which will give the above voltage under load conditions. There are several reasons for this: first, up to the present time the rotary gap has proven most satisfactory for amateur use and manufacturers have for the most part constructed transformers for rotary gaps having a much higher spark frequency; second, the cost of a small high voltage transformer with its increased insulation is usually greater, as is also a condenser with adequate dielectric strength.

We therefore find that the quenched gap is not as popular as it should be in amateur circles, because it is *rarely ever used under the conditions which it calls for.* There is to the author's knowledge a considerable number of quenched gaps distributed to amateurs throughout the country, and although hardly one of them is being operated under favorable conditions, some of them are doing remarkable work with only half a chance. The stations of 2PL, 9PV, 9AFX, 5ZA, and 6ZY, all employing quenched gaps, form a fairly reliable transcontinental line from New Jersey to California, and yet they all can be considerably improved. It will take a lot of time and careful work, but the results are worth it. For instance, 2PL, who uses a 1-kw. Thordarson transformer which is perhaps most favorable for this work, can put only ½-kw. into his closed oscillating circuit, and yet his station has been heard QSA a distance of 1200 miles. With a full kilowatt in the closed circuit this distance could be increased and furthermore New Jersey has not the record of having extremely favorable geographic conditions.

As has been stated before, the existence of low voltage transformers, manufactured for use with the rotary gap, is partially responsible for many instances of unfavorable quenched gap action. Let us take for an example the case of an amateur with a 10,000-volt R.M.S. or 14,100-volt peak transformer. From our formula we find that at 60 cycles or a 120-spark frequency, only 96 watts can be used to good advantage. If we attempt to resonate the transformer by an external inductive reactance, there is a danger of breaking down the transformer insulation. With the transformer alone, however, without any reactance, there is no falling characteristic and only a mushy note resembling escaping steam can be obtained. The only alternative is to insert resistance in the primary of the transformer, which will limit the power drawn from the

secondary and also give the *desired falling characteristic*. This of course will reduce our secondary voltage until we find that 75 watts is the most we can use to good advantage from a 60-cycle, $\frac{1}{2}$ -kw., 10,000-volt transformer. Fortunately, however, it is found that by carefully adjusting the primary voltage by reducing the inserted resistance, we are able to obtain a double-frequency note corresponding to two sparks per alternation, and the useful power is increased to approximately 125 watts. Here is the condition we have, then: a 10,000-volt $\frac{1}{2}$ -kw. transformer which will draw 500 watts with a rotary gap and put perhaps 3 amps. into the antenna, and yet when properly adjusted and used with the quenched gap, will utilize only 125 watts to good advantage, and put only 2 amps. into the antenna, the remaining 375 watts being wasted in heating the primary resistance. This of course is only one of the many unfavorable conditions under which the gap has been used, but it is sufficient to cause the owner to condemn the gap with apparently plenty of evidence to prove that he is justified.

Tests made with the quenched gap on 60 cycles indicate that a 1-kw. transmitter, if used under proper conditions, should be capable of spanning the continent in one jump without jamming every amateur between the two coasts. Rotary gap amateurs are being persuaded to change to C.W. to relieve QRM, but the expense involved in purchasing and the *upkeep cost* of a vacuum tube set makes such a step prohibitive for many. However, a quenched gap set when properly tuned is a step half-way between the rotary gap and C.W. and will greatly reduce the QRM problem.

Now then, just a few words regarding the radio frequency circuits. With a quenched gap, the tuning between the primary and secondary circuits is generally quite sharp, and the coupling between them is far more critical than with the rotary gap. Also the peak value of the current in the primary circuit is extremely high, necessitating the use of heavy primary leads, which of course should be as short as possible.

The decrement or sharpness of the emitted wave in a quenched spark transmitter is practically entirely dependent upon the antenna resistance. This resistance is made up of two components: one useful and one wasteful, both together being responsible for the total dissipation of energy from the antenna system. The useful resistance is that factor which, when multiplied by the antenna current, represents the energy being radiated into space, and for that reason is often known as the "radiation resistance". On the other hand, the wasteful resistance is the factor which results in uselessly heating up the antenna

system and includes ground resistance, hysteresis loss, etc.

It can readily be seen how desirable it is that this last factor be as small as possible for an efficient transmitter as well as for one having a low decrement or sharp wave. A large portion of the wasteful resistance in many instances is caused by high resistance currents. This loss may be greatly lessened by the use of a counterpoise, which is nothing more than a network of wires placed under the antenna a few feet above the ground, and insulated from it. With such an arrangement, the effectiveness of the transmitter, as well as the decrement, is vastly improved and its uses is highly recommended.

A low spark frequency, such as 60 cycles, means that the antenna potentials are exceedingly high, thus necessitating good aerial insulation throughout, or leakage will result. Of course this is dependent upon the power employed, but high antenna insulation is never detrimental, and it is a factor of considerable importance.

We may sum up the essentials for successful quenched gap operation as follows, and if each detail is carefully considered, the results will be gratifying:

(1) A transformer with sufficiently high voltage for the power and frequency to be used, together with an external reactance or some other method for resonating the low frequency circuit.

(2) A condenser capable of withstanding at least three times the secondary working voltage of the transformer with low losses.

(3) An oscillation transformer having a heavy primary winding, good insulation, with a means for easily adjusting the coupling.

(4) A well-insulated antenna system employing a counterpoise if possible.

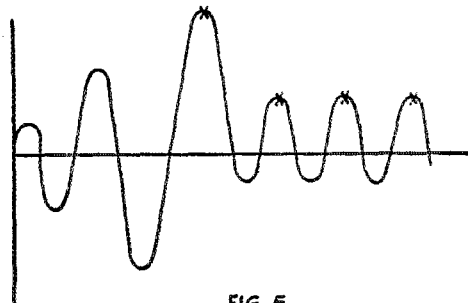

FIG. 5

It is comparatively difficult to fulfill the first three requirements with the apparatus now available, although if those which nearest approach the desired characteristics are chosen, remarkably good results may be expected. As the possibilities and operating characteristic of the quenched gap become better known by amateurs in gen-

eral, no doubt there will be a demand for suitable accompanying transformers, etc. Anticipating this demand, the manufacturers of the Amrad quenched gap are at present developing new HIGH voltage transformers with resonating reactances quite different from anything now on the market.

In this article, an attempt has been made

Reception of 200-meter Signals by Means of a Loop and an Armstrong Super-Heterodyne*

By Leroy M. E. Clausing†

THE advantages of loop reception are chiefly those of a partial selectivity as far as direction is concerned, and the limited amount of space required for the collector. These advantages are however counter-balanced to a certain extent by the inefficiency of the loop as a collector. On this account it has been found necessary to employ radio frequency amplifiers giving high amplification, for receiving signals over long distances with a loop collector.

The difficulties encountered in trying to design and construct a radio frequency amplifier to cover a sufficiently broad range of wave lengths to meet practical requirements have not been overcome up to the present date, but Mr. E. H. Armstrong has shown us a way to get around this difficulty by using a heterodyne, a detector and a long wave amplifier. This system does not appeal strongly to the average amateur because of the large number of tubes involved, and because of the added complication. The latter objection is imaginary as far as manipulation and operation is concerned, if good hard tubes are obtained; some that will not show a blue glow with 150 volts on the plate and the filament current slightly in excess of that normally used.

Since the theory of the operation of this combination of instruments for receiving short waves has been covered by one or two amateur radio magazines it will not be necessary to repeat it here, and this paper will be limited to a description of the apparatus and data on circuit constants.

The Long Wave Radio Frequency Amplifier

The amplifier used by the writer was of the type that employed tuned coupling coils between the successive radio frequency stages. This type will give higher ampli-

fication than the resistance coupled type for a given number of stages and it is therefore the most desirable type for amateur use. The wave length at which this instrument gives maximum amplification need not be critically chosen and for this reason it should not be difficult to construct an efficient amplifier for this purpose. In practice it has been found that 200 meter signals can be heterodyned to any wave length between 1000 meters and 6000

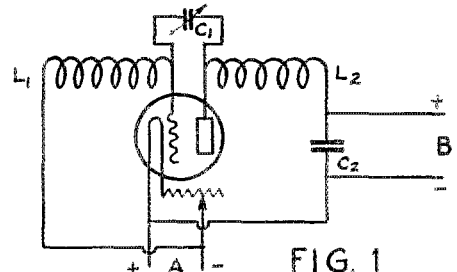

FIG. 1

LEGEND:

- L_1 = 22 turns of #20 D.C.C. on a form $3\frac{3}{8}$ " diam.
- L_2 = 22 turns of #20 D.C.C. on a form $2\frac{7}{8}$ " diam.
- L_1 and L_2 closely coupled.
- C_1 = .001 mfd. (max.) variable condenser.
- C_2 = .004 mfd. fixed condenser (radio frequency by-pass.)

eters. Detailed instructions for constructing radio frequency amplifiers have appeared from time to time in the various radio magazines. Any of these descriptions will lead to excellent results if the instructions are carefully followed. One point that is not usually mentioned in connection with these articles is that the tendency towards internal oscillation in the amplifier is greatly reduced by employing tubes having a low electrostatic capacity between the electrodes. Another advantage is that the wave length range of an amplifier is

*A paper read before the Third District Amateur Radio Convention at Philadelphia, Feb. 26, 1921.
†Radio Aide, U. S. Navy, pre-war 8YL.

much broader when built with tubes of this type. An amplifier having these characteristics is very desirable for amplifying heterodyned signals because the signal distortion is reduced to a minimum.

The Heterodyne

In designing the heterodyne particular attention was directed towards the wave length range (150 meters to approximately 800 meters), simplicity of operation (the entire range was covered by one .001 mfd. condenser), and the fact that all of the

The Detector

The detector circuit is like that of any standard vacuum tube detector as far as the input side is concerned, but it differs slightly on the output side. This difference will be readily seen by looking at Fig. 2, in which the usual telephones have been replaced by the radio frequency circuit C_3 and L_3 .

Fig. 3 shows schematic diagram of complete receiving circuit as used in connection

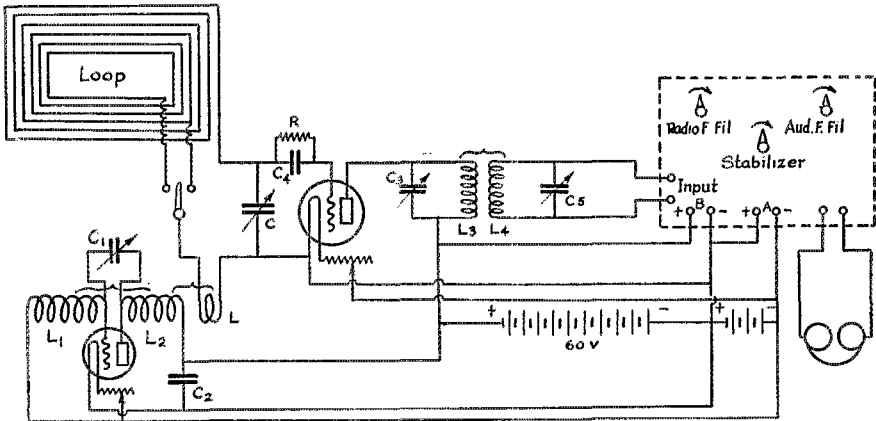

FIG 3

LEGEND:

Loop=6 turns #18 annunciator wire, outside turn 3' x 5'; each successive turn going toward center, spaced 1 1/2" at corners. Tap on third turn for wave lengths between 150 meters and 450 meters.

$L=6$ turns #18 wire on form 4" diam.
 $C=.0015$ mfd. (max.) variable condenser.
 $L_1, L_2, L_3, C_1, C_2, C_3, C_4$ and R =same as in other figures.
 $C_5=.001$ mfd. (max.) variable condenser.
 $L_4=15$ millihenry coil, same as L_3 .

receiving instruments must operate from one "A" and one "B" battery. These points were well covered by the circuits shown in Fig. 1.

with a 6-tube radio-audio frequency amplifier that gave maximum amplification at approximately 5500 meters.

Operation of Apparatus

The following instructions are intended to cover an installation in which the coupling between the radio frequency stages of the amplifier consists of tuned coupling coils. If a resistance coupled amplifier is used the method for adjusting the amplifier for maximum sensitiveness and for obtaining resonance between the circuits C_3, L_3 and L_4, C_5 will not hold. After the filaments of all the tubes in the circuit have been lighted to the proper brilliancy, condensers C, C_1 and C_2 are set to 0°. C_5 is now adjusted until the familiar hiss given by an oscillating tube is heard in the phones, radio frequency oscillations are now present in the amplifier, the small high-inductance coils L_3 and L_4 placed within 1/8" of each other and the capacity of C_3 increased until the familiar resonance click is heard. If the oscillation stops while the pointer of C_3 covers a range of

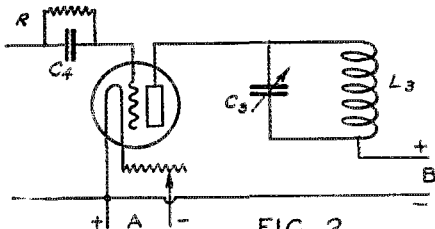

FIG. 2

LEGEND:

R =Grid leak of 1/2 megohm.
 $C_4=.0008$ mfd. fixed condenser.
 $C_3=.001$ mfd (max.) variable condenser.
 $L_3=15$ millihenries when the radio frequency amplifier gives max. amplification on approximately 5000 meters. (made of #36 silk enamel wire wound in form of a "pie", 3/8" thick, 1/2" internal diam. 1 1/4" external diam.)

20° on the scale, it will be necessary to either decrease the coupling between L_3 and L_4 or increase the regeneration by means of the amplifier stabilizer so that the breadth of adjustment for non-oscillation on C_3 narrows down to a few degrees. The amplifier is now at its maximum sensitiveness and the circuits C_3 , L_3 and L_4 , C_4 are in resonance. A slight re-adjustment of C_3 and the coupling between L_3 and L_4 may be necessary later for securing the maximum signal intensity, but after that those adjustments need not be touched. A test is now made for oscillations in the heterodyne circuit by setting C at say 90°, coupling L to L_2 and slowly varying C_1 through its entire range. If the heterodyne is functioning properly a loud roar of static and probably a signal will be heard for two settings of C_1 (both settings are usually within a range of 10°.) If these effects are not obtained, reverse the coupling between L_1 and L_2 . No further trouble should be experienced after this, and by following the adjustments of C with those of C_1 ,

so that the static roar is heard for various settings of C , the tuning is carried throughout the entire range. A small change of coupling between L and L_2 may also be necessary when covering this range.

From the foregoing description it will be seen that after the preliminary adjustments of amplifier circuits and detector output circuit have once been made, there are just two adjustments necessary (C and C_1), for operating over wave lengths between 150 meters and 300 meters, and an additional adjustment when covering the entire range (coupling between L and L_2).

Results

Over thirty different stations were copied within one hour from the following districts: 1st, 2nd, 3rd, 4th, 5th, 8th, and 9th. The average distance of these stations is approximately 500 miles and all but one or two could be copied 10 ft. from the phones. The receiving station was located at Lima, Ohio. The directive effect of the loop is very good.

New Apparatus

THE Radio Corporation of America has brought out a new amplifying transformer especially designed for use with Radiotrons, as shown in the accompanying illustration. It is of the shell type with an overall height of 2 3/4", length 3 7/8", and base area 2" x 2 3/4". The secondary to primary turns-ratio is nine to one, the D.C. resistances of primary and secondary 430 ohms and 5100 ohms, respectively, and the impedances at 1000 cycles approximately as follows:

Primary with secondary open...19,000 ohms
 Primary with secondary shorted...650 "
 Secondary with primary
 open.....1,400,000 "
 Secondary with primary closed.43,000 "

amplification. It is highly essential to connect the transformer terminals as marked; the one marked "G" must always be connected to the grid of the next tube. The diagram here given has the secondary "F" terminal connected to the filament rheostat on the side away from the filament, which puts a bias negative potential on the grid of the amplifier of a value of about one volt when a 6-volt battery is used and the filament adjusted to its correct current of one ampere. This biasing potential shifts the operation of the tube to a point on its characteristic curve where best amplification obtains, and is a point that should be well noted by all amateurs who have built

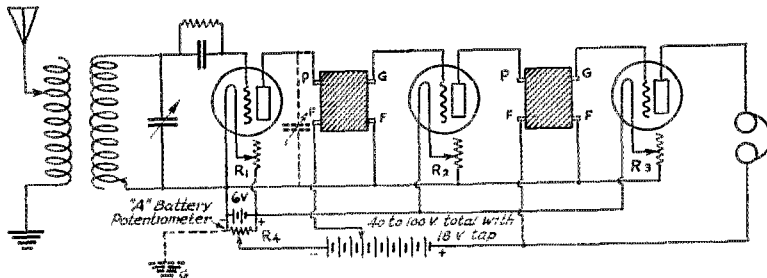

FIG. 1

The wiring diagram recommended by the Radio Corporation for their tubes is shown in the annexed circuit, employing a U.V.200 for detecting and U.V.201's for

their own amplifiers, as it adds greatly to the results obtained and its absence is the main reason why so many home-made amplifiers distort telephone signals.

The Doolittle Decremeter

The measurement of logarithmic decrement is one of the most difficult ones in the adjustment of amateur spark transmitters. This measurement is based upon the well known Bjerknes equation thrown into the form

$$\delta_1 + \delta_2 = \pi \frac{C_2 - C_1}{C_2 + C_1} \sqrt{\frac{I^2}{I_r^2 - I^2}}$$

In practice it is usual to choose the value of I^2 so that it will be equal to $\frac{1}{2} I_r^2$ (half of the square of the indicated current at resonance) in which case the value of the radical becomes unity. In the practical application of the method what is done is to tune a decrometer to resonance with the transmitter to be measured at such coupling as to give a convenient indication on some current-indicating device (usually a current-squared meter) and then throw the decrometer circuit out of resonance, first on

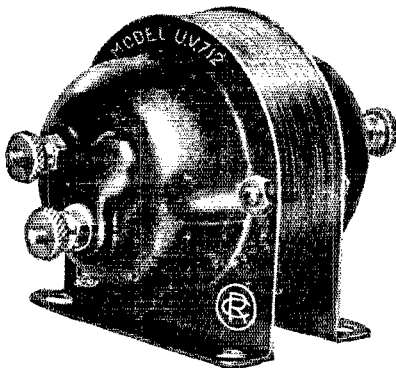

The U. V. 712.

one side and then on the other, until the square of the current falls to half its value at resonance, the respective values of capacity above and below resonance then being inserted in the formula and solved to give the sum of the decrements of the circuit under measurement and the decrometer itself.

The delicacy and expense of a sensitive current-squared meter has kept such a decrometer beyond the reach of many amateurs, but the F. M. Doolittle Co. has brought out a decrometer that is as serviceable and rugged as it is ingenious and sells at a reasonable figure. Its operation is based upon the same Bjerknes theory except that a photometric method is used for determining resonance conditions instead of a meter. It is provided with two small matched incandescent bulbs which are mounted at the bottom of a cylindrical tube, the upper end of which is closed by

a frosted screen, and with a vertical partition separating the bulbs. One of these bulbs is lighted by the current induced in the oscillatory circuit of the decrometer and the other is lighted by two dry cells. The wiring diagram is shown herewith.

The operation of the instrument is as follows: The decrometer is first adjusted to perfect resonance with the antenna circuit as indicated by maximum illumination of the oscillatory circuit bulb. The other bulb is then lighted and the coupling between the decrometer and the transmitter varied until the illumination produced on the screen by the two bulbs is equal. A

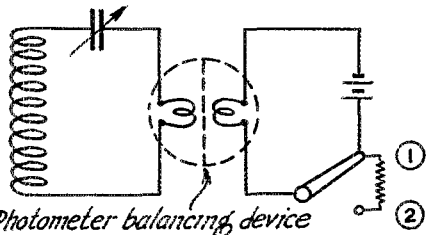

resistance is then cut into the battery circuit by throwing a switch, which reduces the current by a suitable predetermined fraction, and thereby reduces the illumination on the screen associated with the battery circuit bulb. The variable condenser of the decrometer is then rotated, first on one side of resonance and then on the other, until the illumination on the two halves of the screen is again equal, and the scale reading is taken in each position.

The difference between the two readings is the sum of the decrement of the circuit under measurement and that of

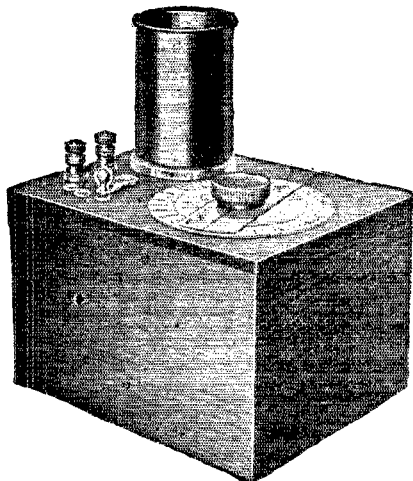

The Doolittle Decremeter

the decremeter itself. The decrement of the decremeter is subtracted to obtain the final result. No complicated calculations of any kind are necessary. The measurement of the logarithmic decrement has thus been reduced to its simplest possible terms, the total time required for making a measurement not exceeding one minute.

In operating the instrument it is important that it be coupled to a turn or two of wire inserted in the ground lead of the station at a considerable distance from the oscillation transformer, so that there shall be no coupling with the latter. This is necessary since the decrements of closed and aerial circuits differ widely and it is that of the aerial circuit which is to be measured.

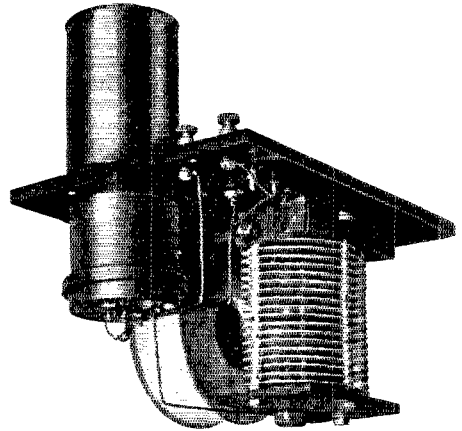

The C. W. Transmitter at 8ZV

By Henry L. Ley

THE following is a description of the little C.W. transmitter which has been in use at station 8ZV for the past several months, with which very satisfactory and consistent results have been obtained.

Probably the most remarkable work which has been done was on the night of February 10th, when speech from 8ZV was copied, with but a few breaks due to QRM, during a half hour period by 3EN, Norfolk, Va. Antenna current at this time was 1.1 ampere and the wave length 375 meters. 3EN reported the speech very clear and of good intensity, having no difficulty whatever in reading, except when broken up by interference from some spark station. Speech has also been reported clear and of good intensity by 3XL, Washington, D. C., on several occasions.

The Radiating System

Mention of the antenna in use at 8ZV is made because of the rather unusual construction, which I have called a "Tee-Fan type". The flat top is composed of four wires, 130 feet long, each spaced 6 feet apart. The west end of the antenna is 65 feet high and the opposite end 55 feet high, the wires and down leads being of No. 10 solid copper wire. Three sets of down leads are brought into the station, which is located under the center of the antenna; that is, three wires are brought down from each wire in the flat top portion, making a total of 12 down leads. One down lead is taken in the exact center, and another 18 feet away on each side of the center, thus forming the Tee-Fan aerial.

Ground is obtained by means of driven rods and connection to the city water

system. The fundamental of this antenna is 205 meters.

The Transmitting Set

The complete transmitting set, excepting the motor generator and filters and the filament heating transformer, is mounted

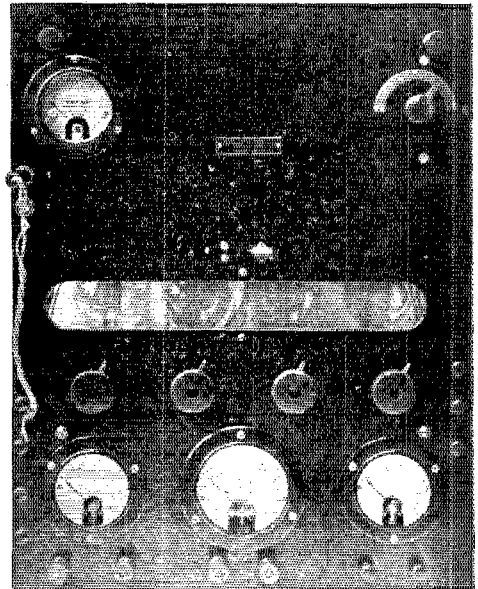

Figure 1.

on a Formica panel 14" x 18" and ¼" thick, front view of which is shown in Fig. 1, a rear view, showing wiring etc. in Fig. 2

and a complete diagram of the connections in Fig. 3.

The circuit employed is an adaptation of the Meissner circuit, to which the Heising method of modulation has been applied for I.C.W. and speech. This circuit has been found to be an excellent oscillator, and very easy of control and adjustment.

Meters are provided for measuring the plate voltage and current, the filament current, and of course the antenna current. Regulation of the plate voltage is obtained by means of a resistance in the shunt winding of the compound wound generator, this being of 100 watts output, and driven

results are obtained when this capacity value is kept low, the normal capacity being of the order of .00025 mfd.

A litz-wound honeycomb coil of 600 turns happened to be at hand, and this was tried as a radio frequency choke coil between the plates of the oscillator and modulator tubes, and was found to function very satisfactorily. A standard modulation transformer is included in the grid circuit of the modulators, and a negative potential of $22\frac{1}{2}$ volts supplied by a standard block battery. A plug and jack enables either the buzzer or microphone to be connected in the modulation circuit, the

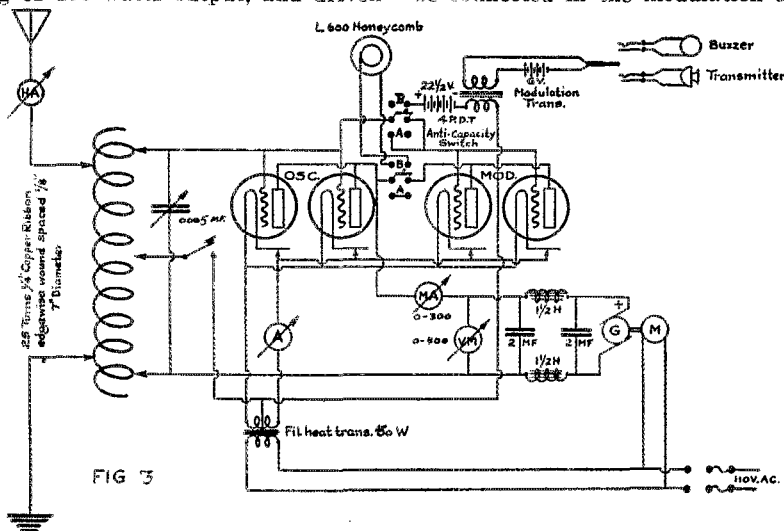

FIG 3

by a 1750 r.p.m. $\frac{1}{4}$ H.P. single-phase A.C. motor, direct connected.

Filament current is obtained from a step-down transformer, the center of the secondary being tapped to overcome the 60 cycle hum, as shown in Fig. 3. A small rheostat is included in the filament circuit of each tube, serving to carefully control the flow of current, which is necessary if the life of the tubes is to be conserved.

Western Electric VT-2 tubes are employed, two for the oscillators, and two for the modulators. It has been found that the new Radiotron U.V.202 5-watt tubes are equally efficient; in fact slightly better results have been obtained with their use.

On account of the key being placed in the feedback circuit it has been found that the tubes may be run at a considerable overload, as the load is not on when the key is in the "up" position.

The inductance consists of 25 turns of edgewise wound copper strip, dimensions of which are given in Fig. 3, around which is shunted a variable condenser of .0005 maximum mfd. capacity, which serves to accurately control the wavelength. Best

key being closed for speech, or used to start or stop the carrier wave when using I.C.W., the buzzer being continuously operated during the time of such transmission.

The anti-capacity four-pole double-throw switch serves to change from straight C.W. telegraph to modulated, and as shown in Fig. 3 will connect all four tubes as oscillators when in position indicated by "A" or connect two as oscillators and two as modulators in position "B". Actually, this has not been found desirable, as very little increase in radiation could be obtained by using more than two tubes in parallel for oscillators, and the circuit did not function nearly so well, probably due to the increased capacity effect of the tubes, so that the connections were altered so that on position "A" two tubes are in parallel as oscillators, and on position "B" the filaments, grid and plate circuits of the other two tubes were connected in as modulators through the radio-frequency choke coil L600.

A Magnavox hand-microphone has been found to give very powerful and clear modulation, and is much superior to any other microphone which has been tried.

When using straight C.W. telegraph, using two oscillators in parallel, the antenna current averages 1.3 amperes, although it has been possible to obtain as much as 1.7 amperes. The plate voltage used is 400, the space current being about 200 milliamperes for the two tubes. The

average antenna current when modulating is 1.1 ampere, plate voltage being reduced slightly, that is to 350 volts, and the space current varying from 200 to 350 milliamperes as the voice or buzzer is impressed on the modulating tubes, with a slight increase in radiation when full modulation is taking place.

The most consistent C.W. telegraph work has been carried on with 2ZL, Mr. J. O. Smith, Valley Stream, L. I. 9XI, University of Minnesota, Minneapolis, and with XF-1, Langley, Field, Va. Many stations up to 1000 miles distant have heard the signals of 8ZV, and the results would indicate that the future for C.W. is very promising for the amateur, that cost of a transmitter of this type not being greatly in excess of a good spark set, with the additional advantage that his traffic will carry through interference and strays where a spark station would have difficulty in working 100 miles.

It might be of interest to mention that it has been possible on numerous occasions to carry on work between 2ZL and 8ZV with the antenna switch in both stations in the transmitting position, and the motor generator running, so that it was possible to "break in" from either station. This method of operation is almost exclusively used when communication is carried on between 8ZG and 8ZV.

It would seem from the results obtained that the C.W. telegraph range for this set under ordinary night conditions would be upwards of 500 miles, while speech under the same conditions would carry about 100 miles.

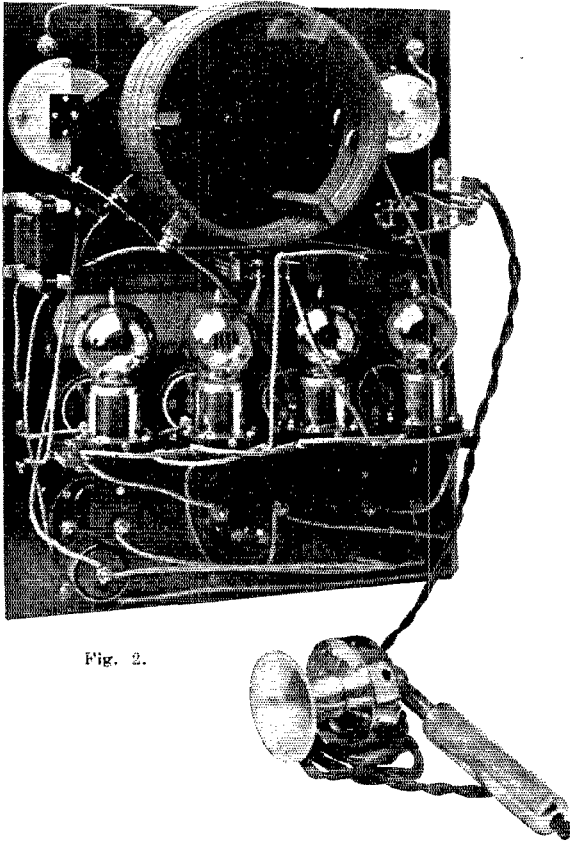

Fig. 2.

SPARK RECEPTION ON HONEYCOMBS

(Continued from page 17)

I have found some sets which could not be adjusted by this method evidently due to some improper wiring, not of actual connection but due to wires being in the wrong relation to each other. In these cases the long waves were received in good shape but amateur stations from any distance could not be received; in fact the station could hardly read any amateurs out of his own town and the 600 meter station were also weak although readable.

Also I have found some tubes which would not operate according to this method and again long distances on short waves were impossible.

In order to check up your set and be

sure the bulbs and set are in workable shape you should locate the quiet spot on say the L-35 coil in the secondary with the secondary shunt condenser at or near zero and follow this quiet spot through to the 180 degree adjustment of the shunt condenser, which will probably mean that the first settings of the primary condenser will be obtained with it in series and set near the zero end and increase up to 180 degrees when the series condenser will be thrown to the multiple position and again adjusted from zero to near the 180 degree position if the secondary condenser is large enough to demand this extreme range on the primary side.

(Concluded on page 56)

EDITORIALS

de AMERICAN RADIO RELAY LEAGUE



Summer Radio

HAVE you fellows noticed the way radio interest is keeping up this summer? We could not help wondering at it the other night when there happened to be but little static and the flivver was out of commission. Usually the latter keeps us away from the set these rare New England summer evenings, but the carbon got pretty thick recently and the transmission got out of resonance and we had to lay her up for a few days. This gave us a chance to get the phones on again and as it happened to be a good night we heard lots of the stuff coming through. It made us ponder over the ways of to-day as compared with the days of eight years ago.

In that prehistoric age, when men used cat whiskers and lumps of galena and loose couplers, radio simply went out of business when the warm weather came around. Static is not with us all the time, even in summer, at least here in the northern tier of States, and there really is no reason why one should not make use of his station and continue with both traffic dispatching and experimenting. The reason we threw up the radio sponge in the early days was because our instruments were so insensitive and also because we were younger, and the warm weather and outdoors appealed more than any other earthly pleasure. There were not many older men in the game then. But to-day, our instruments are super-sensitive, we are older, and while the great out-doors still appeals, we still have our evenings at home and the old set is a never-ending source of interest. Summer no longer is the QRT signal and instead marks simply the advent of a fresh school of experimenters.

The summer air sounds very different from the winter air. The old timers are not present in such solid phalanx. New call letters appear. New operators answer you and you have to consult the QRA book frequently. C.W. experimenters are present this summer in great mobs. We used to think that a fellow with a three letter call hadn't much business fooling with C.W. But summer has changed all this. It seems that most of the traffic and also the C.W. stuff is coming from three letter call stations. It adds an entirely new zest to the game, and we confess we enjoy it.

It keeps us busy consulting the call book and the latest supplements, but it is good fun just the same. And the way some of these three letter chaps shoot the stuff through makes you wonder how the old timers will sound when they get in again.

Summer cuts no figure at all with amateur radio in the northern part of the country, after the first flush of excitement over warm weather is past, and we are glad to see it. It means greater reliability to our traffic handling, greater confidence on the part of the authorities who are taking increasing interest in us all the time, and more stability to the business of our manufacturers, without whom we would not be what we are.

Salem: A Comedy

IN the good old city of Salem, Mass., where they used to burn witches without first giving them a chance to be heard, the city fathers recently passed an ordinance that as a bit of radio humor cannot be surpassed and certainly belongs under the class of light summer reading:

"No person shall set up, install or maintain a wireless apparatus connected with or intended to be connected with a current of electricity without first having obtained therefor a permit in writing from the City Electrician".

Shades of T.O.M.! What could be more rotten than that? In the first place it's duplication of effort, for a Federal law states that a radio license gives its possessor authority to operate a station and the underwriter's inspection code is sufficient guarantee for the public safety. But granted that the Salem council has the privilege of passing any additional measures they deem necessary for the good of their citizens, there is still much to be said. The Salem amateurs under the energetic Brother Estey of course promptly rose on their hind legs and protested, but the council wouldn't and won't give them a hearing, and seems to think the ordinance is very nice as is, thank you. That chosen representatives of the people should so conduct themselves is astonishing. But the ordinance is more so, for notice that while a permit is necessary no rules are stipula-

ted which must be complied with before a permit is granted, leaving the fate of Salem amateurs in the hands of one unfriendly man, with no appeal possible, a situation which will be recognized as paralleling the Poindexter radio bills. Such autocratic provisions we consider unconstitutional and certainly contrary to the spirit of our democratic government.

And say! Do the city fathers mean to tell us that we must have a permit for a receiving station? Hi! Yet all modern receiving sets certainly contemplate connection with a "current of electricity"—two of 'em, in fact: A and B batteries. Of course they meant transmitters but they didn't say so. And the word "maintain", so Mr. Webster says, means to hold or keep or possess. From which it follows that there is no place within the city limits of that dear Salem in which one may even store a piece of radio apparatus without permit and that any dealer who stocks equipment for amateurs does so in violation of law. Hi again!

Gentlemen of the Salem Council, the radio world is laughing at you. From coast to coast your ordinance is hailed as a darned good joke. It does not say what you mean it to say and it says a lot that it shouldn't, which is a dangerous situation. It ought to be promptly repealed. Then, if you still think you should have municipal regulation of amateur radio (which by the way we think wholly unnecessary and amply covered by existing regulations), for goodness' sake call in some representative Salem amateurs and get the thing straight. You won't have to fight amateurs, gentlemen; you will find them more than anxious to co-operate with you, for co-operation is a basic principle in amateur organization.

More Folks Should Read QST

THE good work that the A.R.R.L. is doing in the advance of Citizen Wireless Communication ought to be better known than it is. Radio men seek QST wherever they go but the great general public rarely hears of us and is not aware that in this land there exists a nation-wide organization of citizens who are able to communicate with each other over privately-owned equipment, who are carrying on a noble work in the advancement of science, and who are of genuine public value in countless ways.

There are lots of people in the non-radio public that should read QST—legislators, police folks, city officials, etc. Our work would be more fruitful and more channels for our activity would appear if we were better known to influential men all over the country. So we want to ask A.R.R.L. members to help us in the compilation of a

mailing list to whom we will send free copies of QST for the general good of amateur radio. It costs money to print QST and we are not prepared to take on an unlimited complimentary list, so there must be no "dead timber" in it, but sit down and think hard and write us the names of influential folks you know whose appreciation of our work would aid the cause of amateur radio, and we will very gladly do the rest. We thank you.

The Transition

IN every mail we get news of another good spark station gone wrong—the apparatus junked or offered for sale. "I'm putting in a good C.W. set", the writers say, "and I'll be all ready for business by fall."

That simple little story is being repeated in every town every day. Men, we have reached the great transition—the dawn of the change we have been expecting. The spark is not "doomed"; not a bit of it; we will have sparks with us for years to come. But co-operation, if nothing else, will demand that they be improved in their interfering proclivities and only the really good ones will survive. And the mediocre spark station will surely pass, for the simple reason that it can be easily surpassed by a small C.W. set. Thus by fall we expect that the situation will be pretty much this: the average DX station will be C.W., and the DX sparks will be those few really good ones whose owners are satisfied with their range and hesitate to venture into a new field.

Meanwhile traffic suffers. To be blunt, traffic work is shot all to the devil, what with rotten weather and experimenting with C.W. This period has been foreseen, tho, and we are fortunate that it has come upon us in the summer when traffic is naturally light, and doubly fortunate in that we will be all set for traffic by cool weather. A.R.R.L. members will not forget that our main work is the DX handling of citizen messages, and we want to work hard, all of us, to get the C.W. sets whipped into shape so that our traffic can rise to its normal proportions with the coming of fall.

It certainly is a comfortable feeling to have a good C.W. transmitter. It will work at wave lengths so short that a spark set wouldn't have any output worth mentioning if it tried to get down as low. It goes bumping thru the static when the sparks are helpless. It's compact and quiet, and Oh Brother what distances per watt output! The experiences of those actively on the air with C.W. sets has amply proved that our faith in the quiet efficiency of tube transmission was well founded, and the earnest consideration of these facts is asked

of the dwindling minority of "spark hounds".

So here's the word, fellows: traffic is suffering, as suffer it must while the change is on, but let's make it short and snappy and bend every effort to getting the C.W. sets (and that very positively includes receiving sets) lined up for DX work by the time September rolls around.

And next winter we'll have an All-CW Transcon Route! Will you be on it?

Canada

THERE has been a little agitation in Canada about a separate relay league. It has been intimated that "the Yanks are trying to run things for their own fun". The flag has been waved and lurid talk made of the danger of continuing in the A.R.R.L. because of the possibility of war between Canada and the States, etc.

Fortunately saner views have prevailed and the wild bolshevistic part of the movement has expired, so that it is assured that if Canada has a league of her own it will hand in hand with A.R.R.L. We want to take this opportunity to clear our hook to our good Canadian friends on a few matters that are not as well understood as they should be:

The A.R.R.L. Operating Department was expanded to take in Canadian work in co-operation with our own at the earnest request of some well-informed Canadian amateurs. The Division Managers are Canadians, and always will be, and except in the broader observance of A.R.R.L. policies as universally known and approved these managers direct their divisions in complete accordance with their own peculiar local conditions. We have never really dared to hope that Canada would want always to remain within the A.R.R.L. organization, much as we would like to see such a permanent union. Our idea has been to give a helping hand to a land in which amateur radio is much younger than it is in our own, and in this we honestly believe we have been succeeding and that the well-posted Canadians agree with us. Let us say, if there be those who don't know it, that it isn't at all a case of the Yanks trying to run things to suit themselves. Such a policy is entirely contrary to basic A.R.R.L. ideas, which are founded on democracy and for that very reason have stood the tests of seven years. Whenever it is apparent that Canada needs a separate organization and a promising framework and supporting stations for that organization come into existence, the A.R.R.L. will be ready to recognize it and co-operate fully.

But that time is not yet here. Canadian stations are as yet limited in number and in range, and for a season or two more

the bulk of the relaying into and out of Canada will be north and south via various cross-overs from the States. The best minds in Canadian amateur work are agreed that until such time as Canada has east and west lines of its own it needs the supporting arms of the A.R.R.L. This is vastly wiser than any hasty proposal of separation, and after all we are all of us working to a single end: the furtherance of citizen relay communication.

Let brotherly love prevail!

Radio Amplification

MR. Manufacturer, isn't there some way you can take care of us amateurs in our need for radio-frequency amplification? We need it, and need it badly. We have realized it for a long time and have been watchfully waiting in the hope that something would develop but we're still where we were before the war.

The principle of audio-frequency amplification is all wrong for our amateur work. All it does is to boost the strength of signals that already exist in the detector almost loud enough to read, and it is of almost no help in the case of signals that cannot be heard in the detector circuit. And tube noises increase in faster proportion than the amplification of weak signals.

An audion detector is "unfair" to weak signals, as its rectifying properties depend upon the square of the impressed voltage, with the result that strong signals are amplified more than weak ones, which is obviously undesirable. Radio-frequency amplification boosts the signal amplitude before it is rectified, and there being no tube noises at this frequency, many stages can be used if necessary. There is no doubt at all in our minds that a little r.f. amplification would make coast-to-coast reception a common thing in amateur work.

The present tubes are of no particular value for this purpose, as the capacitative reactance of their input circuit is so low at our high amateur frequencies as to practically short-circuit the ordinary means for repeating from one tube to the next. Tuned output circuits perhaps have some promise, but the plurality of controls involved in such a scheme is discouraging. What we need is a tube of very low internal capacity, with tiny elements, having lead-wires separated and brought out remote from one another, and either mounting in tiny clips or being suspended by the lead wires themselves like the good old AudioTron.

Now, Mr. Manufacturer, why can't we have them? Canadian amateurs have the V-24, a British Marconi tube which seems fairly satisfactory for this work, but the

(Concluded on page 56)

The Operating Department

F. H. SCHNELL, Traffic Manager
1045 Main St., Hartford, Conn.

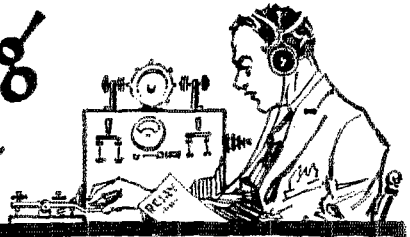

OUR message traffic certainly did a "Carpentier" last month, dropping to a total of 4380 messages which were reported as follows: Atlantic 1760, New England 302, Central 793, West Gulf 682, Northwestern 119, Roanoke 125, and Ontario 99. Of course message reports are missing from several divisions but it seems that QRN is playing havoc with our traffic. We know that the terrific heat has done much toward keeping men out of their shacks. One thing that stands out more prominently than any other is the fact that spark stations are being dismantled and sold while C.W. sets are taking their places very conspicuously. The entire amateur world seems to be undergoing a change. CW, CW, CW is all one hears these days and the fall and winter will not find all of those famous long distance spark stations but in their stead will be the little squeal of the CW reaching out over greater distances than those old familiar sparks that one could recognize before the call was signed. Those familiar sparks did handle messages by the hundreds, but CW will be the means of better and more reliable communication. We can be sure of less QRM from sparks as, at the present rate of dismantling, there will be but few left.

The Atlantic Division takes first honors with the busiest station this month.

 MR. F. B. OSTMAN, 20M
 Ridgewood, N. J.
 306 Messages
 Atlantic Division

Mr. Bessey, Pacific Division Manager, seems to have trouble in getting his men to send in reports of messages handled. We have not had a traffic report from that Division since we started keeping count and we ask that all amateurs in the Pacific Division assist their Manager by sending in a report of messages handled during the month. Let the rest of the amateurs see what your messages will total for a period of one month. Come, you fellows on the West Coast; you can do 'most anything else; now let us see a report of traffic,

We know you are there because Bitz, 6JD, told us so.

After Mr. Russell, Ontario Division Manager, gets over his latest excitement of being married, he is going to start a campaign for good relay material for the coming winter and he wants all men to make immediate application to him for appointments. There are many vacancies and Mr. Russell wants the very best men he can get.

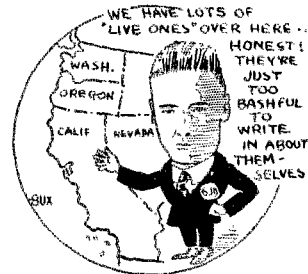

Those good amateurs in the West Gulf Division under the management of Mr. Corlett have certainly shown a wonderful spirit of co-operation and they are to be commended most highly for their excellent work. This division was hardly known a year ago, while today it is rapidly showing the result of persistent effort on the part of those men who stand for the best in amateur radio. We take our hats off to you men in the West Gulf Division and may you keep up the good work in the interest of Citizen Wireless.

Some confusion is going to result in the New England Division because practically all the three letter calls have been changed, and we ask that all amateurs be kind enough to re-address all mail to the proper stations until such time as the calls become familiar again.

The reports of the Division Managers follow:

ONTARIO DIVISION
A. H. K. Russell, Mgr.

In Ontario the summer season is usually devoted to building and installing apparatus. The short wave length allowed the amateurs near routes of navigation makes

it extremely difficult to do any DX work, although certain amateurs (ex-commercial operators), have been able to get special licenses for 200 meters all the year round, but they have to contend with the static, which is beginning its ravages up here, and usually do not get very far.

The station of Mr. Rogers, 3BP, is the star station of the Province. He is located in an inland town, forty miles from the nearest commercial station, and is consequently allowed a wave length of 200 meters. He has been getting a lot of traffic through south as far as Kentucky, and east as far as New York, and is heard in Hartford. Total msg's. handled, 70.

In Toronto, there are quite a number of CW and fone sets in operation, but very few of them have been able to get through to any distance. Station 3GE, using $\frac{1}{2}$ k.w. spark, has so far kept a traffic schedule with 8CG at Niagara, and has handled quite a number of both outbound and inbound messages. A new spark set is being installed at this station and will be in operation by September 1st. It is expected to establish constant communication between Windsor on the west, and Kingston or Montreal on the east. Station 3EI is getting in shape for the DX work next fall, and 3IN is heard regularly by 3BP, forty miles away over land, and is only using a one-inch induction coil. According to Mr. Rogers, he comes in much louder than many of the amateurs at the same distance using $\frac{1}{2}$ K.W. transformers and rotary gaps.

The Wireless Association at Toronto has closed down for the summer on account of a number of the members not being present at the meetings during the hot months.

H. J. Carter of Windsor reports that heavy QRN does much to retard the relay work except at distances of 150 miles or closer. An average of about two nights a week is all that can be depended on. A valuable station has been located at Amherstburg, Ont., about 20 miles from Windsor. Most of the traffic handled has been coming in for Michigan points. Total messages at 3DH—31.

H. S. Gowan of Kitchener, Superintendent for Southwestern Ontario, reports the opening of a large number of stations in his territory. 3PM of Brantford has started with a 60 cycle transmitter and a short wave regenerative receiver, and has been reported QSA by a number of stations. At St. Jerome's College a new station has been installed including a $\frac{1}{2}$ K.W. 25 cycle spark with Grebe receiving equipment, call 3QJ. The D. S. helped unpack the Grebe apparatus and with one step of amplification, and an indoor aerial 200 feet long lying on the floor near radiators and pipes heard NSF QSA and 2XK over 75 feet from the phones while at 50 feet 4GL

and 8RQ, both on CW, were easily heard, in addition to many spark stations.

3KL of Preston has installed a transmitter and is coming along fast. The most certain route of this division is via 3DS, 3BP (Newmarket), and 3GE, 9AL or 3E1 (Toronto) and 8CG (Niagara Falls) or often 3BP can hand the messages direct to almost any part of the United States east of the Mississippi. 3KA of Guelph is installing an efficient transmitter. He has of late been getting very good receiving results, having copied music from KDKA on a crystal receiver. A 20 watt CW set is in process of installation at 3OP Woodstock. The Superintendent's station at Kitchener has installed a new transmitter consisting of two $\frac{1}{4}$ KW Acme transformers with the primaries connected in parallel and secondaries in series. He has been heard by 8WY and was copied in Buffalo on crystal, and his signals are quite consistent in Toronto. Total msg's handled by 3DS—19. Taken altogether, this is the most progressive district in the Province. If they keep on at this rate, they will have a fine schedule going by next winter.

Mr. Donnelly, Supt. of Kingston District, reports that most of the transmitting carried on there now is done by means of low power buzzer and spark coil sets to avoid interference with the local Marconi station, but the Kingston Radio Association is installing a CW set and expects to be handling messages in a short time. Total msg's—10; 3HF—3; 3HE—6; 3HN—1.

A test was carried on to try to establish communication direct between 3GE (Toronto) and 3HE, but on account of QRM and QRN it was a failure.



Mr. Woodley, Supt of Belleville District, reports that a CW station is being erected there which will be a very important link in our chain from Windsor to Montreal. The distance between Toronto and Kingston is rather great for steady daylight transmission, and this station midway between the two cities will act as a stepping-stone. Most of the stations in this division are closed down at present, on account of the examinations at school, but as the

owners finish school they open their stations, and in the course of a month everything will be in full swing again.

NEW ENGLAND DIVISION G. R. Entwistle, Mgr.

DX work in the vicinity of Boston has considerably decreased due to the summer QRN. Nevertheless, our old standbys seem to get the traffic off without any great delay.

Castner (1UQ) reports activity as still continuing in Maine. A regular route has been established via 1LBR that is a great aid in expediting traffic to the west. 1UL, 1CAO and 1PAT at Bath are constantly on the job and no traffic dies there. Station 1HAK is successfully operating an ICW-CW set and is working several DX stations all over the district. In Maine he is very QSA everywhere and is on with a concert almost every night from 9 to 11 p.m. Preparations are being made for the Second Annual Citizen Radio Operators' Convention of Northern New England and the A.D.M. is doing all possible to make it a real success. 1BBK is equipped with the most modern apparatus including a 2-50 watt tube set and will be on during the summer for DX. Special efforts will be made to establish records from this station.

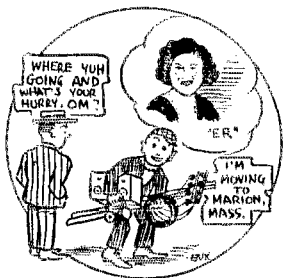

A.D.M. Mix reports following traffic. Southern Conn. Dist., H. E. Nichols, Supt.: 1HO 29; 1BM 12; 1FW, 1UAW and 1FAQ nil; 1QN and 1FQ on but no report. Northern Conn. Dist., J. C. Randall, Supt.: 1NAQ 53; 1AW 40; ITS 47; 1MO 3; 1JBF 6. No report from Western Mass. 1NAQ's call has been changed to 1ANQ.

1CK has suspended operations for a short time and expects to erect an entirely new antenna system at an early date.

Vermilya reports that during this month 1ZE handled ONLY 258 messages due to bad weather conditions. A new station located at Mattapoisett and owned by Miss Eunice Randall, now famous as the "O.W. at 1XE" has recently been erected. A 2 KW 500 cycle set has been installed at 1XE, but some trouble has been experienced in properly driving the motor generator.

1CBK has lately overhauled his station and now comes forth with a real husky spark.

Supt. Johnson (1DY) reports stations in the north coming in better during the past month, especially 1OE, 1DAL, 1YB, 1NBP and 1LBR. 1LZ in Lowell also comes thru QSA. Amateurs who have had high waves have almost all reduced them. 1DY handled 156 messages during the past month; 1SN 113; 1SAF 85.

ATLANTIC DIVISION C. H. Stewart, Mgr.

Traffic in general is falling off with the coming of summer static and the absence of operators from their stations. On the other hand there is a great deal of activity all over the division in reconstruction. The CW transmitters are proving their worth in cutting thru static.

Northern New Jersey, F. B. Ostman, 2OM: Altho 3XM, Princeton, is closed for the summer the Northern Route, New York to Philadelphia, is now in operation and a daylight route is in operation. Mr. Gaete, 2BG of Paterson, is filling the gap made by 3XM. Up to the present writing the following stations are listed on this route and traffic handed to any of them will be QSR'd without delay: 2OX, 2OM, 2SQ, 2BG, 2CL, 2RU, 2KY, 2UK, 3NB, 3EH, 3CC, 3HX, and 3HJ. 2OX handled 36 messages, 2AXB—60 msgs. Reports were not received from other stations in this district.

Southern New Jersey, Marcus Frye, Jr., 3NB: Conditions in this district have been normal for the past month, regular summer signals coming thru. Stations north and south which are difficult in the winter are being received quite consistently. West to Pittsburgh signals are fair with dead spots beyond that point. Very good work is being done with middle and eastern Penna. and New York stations. Baltimore and Washington are now connected and traffic is moving quite regularly. 3FB is still out of commission. If 3DT comes back he will fill the gap made by 3FB. 3FS and 3HD in Philadelphia have been reported causing bad QRM after 10 P.M. doing local work. 3EH has handled 30 messages with stations north and south. 3NB handled 125 msgs. Total for the district about 250 messages.

Hudson Valley District, C. E. Trube, 2BK: Progress during the past month has not measured up to the expectations, probably due to QRN. Wanted: ONE RELIABLE STATION TO FILL THE GAP BETWEEN ALBANY AND POUGHKEEPSIE. 2BM is busy with music and cannot spare the time to operate. 2DA is bothered with QRN, (so is every one else —T.M.) and even daylight work is next to impossible. Old standby 2UA cleared 121 msgs. 2UA has four ops. and is open

for business every night from 11 P.M. until 2 A.M. (When we say business, we mean relay traffic business as 2UA is very very seldom heard chewing the rag and we have heard him giving and taking messages by the handful with 1ZE.—T.M.) 2BK cleared 178 messages.

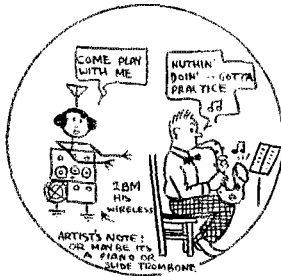

Long Island, H. S. Collins, 2AJW: The few regular standbys in this district have been on the job as strong as ever and QRN does not seem to feaze them. 2EL is setting the pace with his good work west and south. 2EL moves traffic with Savannah direct on schedule. 2BGR has a schedule with 1HO in Bridgeport and cleared 54 msgs last month. 2AJW has 44 msgs to his credit. 2ZL still holds up his end with his far reaching CW set which consists of 2 fifty watt tubes on A.C.

Capitol District, F. H. Myers, 2FG: A few gaps between Utica and Rochester need filling. Help! We need stations between these two points to complete a daylight route. More help! 2SZ and 2AWF did not make out reports but they both have been working consistently. 2FG is undergoing repairs. Tests will be made with 8HP with a view of establishing communication between Albany and Utica.

Western New York, Benzee Bros.: 8AMZ of Oakland is installing a 1 K.W. spark. 8AHV is closed for the summer. (WHY?) 8MF, Woodmansee of Buffalo, is moving to Mesa, Idaho, where he will continue good work for the League. (R. T. Gal-yeau—Take due notice thereof and govern yourself accordingly.—T.M.) 8AYM and 8TY of Jamestown handled 62 messages. City Manager Young reports that 8QM and himself are doing good work on CW. Daylight schedule with 8VH of Erie and Buffalo is working in fine shape. V. Graham, 8IX of Rochester, has been appointed City Manager to succeed Mr. Haire who resigned. The busiest station in the district was 8CG with 109 messages, while the total for the district was 284.

New York City, E. A. Cyriax: Thru co-operation it is now possible for some of our good relay stations right in the heart of what is undoubtedly the most congested section of the country to clear DX traffic with stations in other districts. 2CT with

his CW set is doing excellent work, also 2YM and 2IF. 2DI cleared 74 messages. Matthias Thury, 2CT, has been appointed Asst. Dist. Supt.

Brooklyn, N. Y., F. A. Maher: Traffic has been moving but QRN has shown its strength. 1st and 3rd district stations have been fading badly. 2PF has been added to the list shown in last month's report and we expect to keep traffic moving. 2RM handled 52 msgs, 2WB 60, and 2PF 67.

Central Penn. District, W. A. Cawley reporting for Mr. Walleze: Traffic is moving quite consistently altho a few of the official stations are closed for the summer, while the majority has adopted the plan to work right thru the summer. 8XE, our intermediate station on trunk line "B" between Milton and Pittsburgh, has closed for the summer. Quite a bit of traffic has been coming thru 8RQ and several other stations. 8RQ comes thru well on spark or CW. Our main jump between here and Reading on trunk "B" is gradually getting in shape. We have had numerous tests Sunday afternoon and we get 3LP, 3AIC and 3GX of Reading OK, which stations have not been coming thru before. 3LP gets our signals OK at nite. Up to the present we have been giving our east-bound traffic to New York or New Jersey stations. Traffic to the south has been going via 3AQR or Baltimore direct. Traffic to the north goes via 3BP (Canadian) or direct to Western New York.

Eastern Penn., S. W. Place: I. E. Aston, 140 E. New St., Lancaster, Pa., has been appointed Traffic Asst., covering counties of Lancaster, Chester, and Berks. Mr. Aston reports communication between Philadelphia and Harrisburg is working fine, 3ACS or 3ZO to 3WX or 3AGT. 3WX also works 3AIC and 3LP at Reading. 3ABP and 3DB are in active communication with Harrisburg and Lancaster. 3AVG has moved to Pittsburgh and now has the call 8VE. R. C. Ehrhardt of Dunmore reports nothing new since last report. 3ZA has had condenser trouble for the past month but is back in action again. 3CC has been doing excellent work all thru the year, but few reports have been received from him. 3CC works on schedule with 3XF on Monday, Wednesday, and Friday at 9 P.M. 3CC—68 msgs. (3CC comes thru quite well and we hear him very QSA in Hartford.—T.M.) 3CC uses CW and spark and works 3AS of Ocean City when conditions permit. 3BH is no more, as a special has been granted with the call 3ZV.

District of Columbia, F. M. Baer: Traffic has increased during the past month. 3IW is the star station with 80 msgs, 3AAO—71, 3XF—15; total 166. There is nothing further to report.

Eastern Maryland District, G. L. Deichmann, Jr.: Messages handled, 3UC—6,

30U—17, 3HG—38; total 61. Our total would be greater if all stations in Baltimore would make their reports to the D.S. by the 18th or 19th. 3HG and 30U have handled a considerable amount of traffic under the poor conditions of QRN and QRM. 3DW and 3AN have been doing good work. 3AJD, 3YH, 3ER, 3EQ, 3CT, and 3TN are making rapid strides in an effort to keep traffic moving in cases of breakdown of 3HG or 30U. More interest in radio is being shown this summer than previously, which may be due to CW coming into the field.

ROANOKE DIVISION

W. T. Gravely, Mgr.

Severe static has brought relay work throughout the division to practically a standstill except on the part of C.W. stations working C.W. stations, and has greatly limited even this sort of traffic. Interest however has not slackened and much construction work, especially on C.W., is reported in every town.

The reports of the D.S.'s from certain sections of the division contain a great deal of information concerning stations contemplated and in the course of erection. While this information is desirable we do not think it worthy of a place in QST, consequently in the future this report will contain information only about those stations actually handling relay work.

3AOV of Stonega, Va., is handling traffic right along now and has connected with 5DA, 4AG, 3BZ, 3CA and several middle west stations. Gundry deserves a great deal of credit for the way he has developed his station under difficulties that would discourage a less persistent worker. He is giving valuable aid in Western Virginia.

Dr. H. M. Quisenberry, Lexington, Va. has been assigned call 3ZX and is being heard in several places. Wave length 350 meters. He is expected to form an important link in the central Virginia route this fall.

3ZL, D.S. Blair of Richmond, is handling traffic on regular schedule with 3XM but reports that his sigs are not heard in Norfolk a comparatively short distance away. Amateurs in both cities should make diligent efforts to connect up. Blair promises a route through the center of the division this fall starting at Norfolk, ending at Fairmont, W. Va., and including the cities of Richmond, Lexington, and Roanoke.

The following stations are using C.W. to good advantage, 3BZ, 3EN, 3VV, 3MM, 3AEV.

3GO will soon be in the air with a very powerful C.W. set and will be second to none in the country in range, equipment and personnel. 3FG has been closed up

due to pressure of business on Mr. Herndon. 3EZ, Blanford of Portsmouth, has broken out into the big lot and is handling considerable traffic.

While the number of messages handled during the month cannot be accurately stated it will run about 125. Credit for the majority of these msgs goes to 8SP, 3EN, 3VV, XF-1, 3ACT, 3ACE, 3ACK, 3EZ, 3AOV, 3BZ and 3ZL.

The situation throughout North Carolina remains the same, that is, stations promised and being worked on, but very little actual work carried on. As soon as a good station appears in Charlotte that city will be connected with both Winston-Salem and Danville for short-jump traffic to the south.

Several more good stations are badly needed in W. Va. and it is hoped that by the opening of the coming season there will be more good DX stations there.

Complete routes covering the entire division are being worked on and will appear in next QST.

WEST GULF DIVISION

Frank M. Corlett, Mgr.

Summer and the terrific static that goes with it is upon us, judging from all reports received, and I personally know that there is SOME STATIC. Notwithstanding the heavy QRN some actual relay work has been done as the reports from the various District Supts. show.

Oklahoma District, Lorin G. Dill, Supt., 234 S. Broadway, Oklahoma City: Your District Supt. recently made a trip to the eastern section of the state in and around McAlester. There are several good receiving sets there but room for improvement in transmitters. Mr. Poor and Mr. Cooper own the only two transmitting sets. Mr. Cooper is just getting in the game and of course will improve with age. Mr. Poor is making some changes in his gap and will then have a very efficient station. The C.W. craze has hit McAlester too and a number of sets are under construction. Fellows, don't wait for your Dist. Supt. to "find" you but report to him what you have in the way of a set. He may want you in his organization. Muskogee stations have been in the air more than any other Oklahoma stations and 5MF seems to be the busiest of the three. 5RK at Norman is doing some active work. 5JR of Enid is continuing to "kick out". Operator of 5MF visited headquarters recently. 5FO also of Norman expects to have an efficient set in operation soon. 5LO of Miami is still in working condition. Two new stations, one a ¾ K.W. and the other a 1 K.W., are under construction in Oklahoma City. Traffic throughout the district has been moving very slowly. 5HL Oklahoma City can work 5ZA's CW thru some

of the heaviest static. CW sets to the north are heard and worked at times. For the most part traffic north goes thru 9OE, 9QO, 9AP, and 9AEG. To the east thru 5JD, 5RK, (do not hear much of 5YH any more). South 5ZAA, 5ZU, 5ZX, and west to 5ZA. Old 5CP Oklahoma City will soon be in operation with a CW set. Mr. Miracle is installing a $\frac{1}{2}$ K.W. set at Krebs. No report received from Mr. Selby of Muskogee. All stations are requested to report on the 15th of the month the number of messages handled during the preceding 30 days. Our district makes a poor showing in number of messages handled this month due to stations not reporting. 5HL handled 67 messages and this will have to be our total for the district. Let's have your reports, fellows.

Northern Texas District, Harold P. Heafer, Supt., 516 W. Jefferson, Dallas: According to reports received most of the work in this District has been confined to the Eastern Territory, specifically Dallas and Dallas County. No report received from A.D.S. Martin of the Western Territory (this is Martin's first offense). No report received from John Dorsa, A.D.S. Eastern Territory. Mr. Guy Neel, 5XJ, Dublin, A.D.S. Central Territory, makes a rather lengthy report dealing mostly with descriptions of various stations in his Territory. Mr. Neel has just returned from a trip to Brownwood, Texas, where he succeeded in lining up two promising stations. 5NS of Granbury will have an efficient set soon. This will complete a short-jump route from Dallas, Ft. Worth, Granbury, Dublin, and connect with a set being installed at Pecos, Texas, by Mr. J. F. Garrett, which we understand is to be a 1 K.W. Mr. Bennett Emerson, 5ZG Dallas, has been appointed City Manager in charge of Dallas and Dallas County and makes his first report. Emerson says he is going to do his best, with the co-operation of the Dallas stations, to make Dallas a dependable relay point rather than the nest of inefficient stations jamming each other as has been generally the case heretofore. The City of Dallas is divided into four sections with an assistant to be appointed in each section who will report direct to the City Manager. Unlicensed or unauthorized calls will not be permitted; every transmitting set must have a license. The District Supt. has furnished the City Manager and Division Manager with large maps of the city and a complete map system of all stations will be kept showing the exact location of every station in the city. Together with this will be kept a card system giving the details of each station. There are a number of CW sets under construction in the district.

5ZAF, Mr. William P. Clark, Waco, Tex., was the busiest station for the month, handling 238 messages. Total messages

for the district 376. I want to again impress upon the various stations to report on the 15th of each month the number of messages handled the past thirty days. Make this report to your traffic officer of your immediate city or territory as the case may be.

Southern Texas District, W. H. Tilley, Supt., 4112 Ave. F, Austin: 5ZU and 5ZAG seem to have been left with the "bag to hold" in the Austin Territory. They are both working day-light schedules with 5YK, Mr. Sahm, New Braunfels, Texas. 5YK has handled 104 messages during the month, mostly with 5ZU, 5XI, and some with 5XB, 5YI, 5ZAC. Night work of course is difficult due to heavy QRN. 5YK believes in the early morning work and wonders why more of the fellows don't try it.

Austin stations are complaining of not being able to work north. 5ZU and 5ZAG are working during the day-time and want some station north in the vicinity of Waco to set a schedule with them to clear traffic north and south. (What's the trouble with 5ZU and 5ZAG getting together with 5ZAF at Waco?—D.M.)

Mr. Daniels, 5ZX, A.D.S. Houston Territory, makes an interesting report as usual. Several of the Houston stations are undergoing radical changes, among these being 5ZE, 5ZT, and 5HZ. 5ZX is in operation every night, QRN or not, and doing such work as is possible. 5ZX has also been doing some daylight testing with 5XI and 5XJ. 5JK is daily broadcasting time signals and QST's at the usual hour, giving rest to the stations who have long been doing that work. 5ZW has been experimenting with CW and 500 cycle spark. 5EC, 5CA and 5ZAA have gone to sea for the summer. Our principal relay station, 5XB, has shut down for the summer which cripples our short relay system throughout the whole district. Total number of messages handled 83, with 5ZX handling 23 and 5ZW 15, these being the busiest stations. Total number for the Southern Texas District 239, with 5ZU handling 156 and being the busiest station. Once again, if you fellows don't tell me what you and your stations are doing don't blame anyone but yourselves for it not appearing in QST. Send in the dope.

New Mexico District, Louis Falconi, Supt., Box 421, Roswell, N. M.: No report received.

CENTRAL DIVISION

R. H. G. Mathews, Div. Mgr.

During the month of June activity in the Central Division has been at a minimum partly due to the fact that many of our best stations are being rebuilt in preparation for the coming winter, while others are installing CW sets to be used later in the summer. In some districts CW trans-

mitters are already in operation and these districts are carrying on traffic work almost as well as during the winter months. This is particularly true of the District of Eastern Ohio which is handling east coast traffic regularly. Henry Klaus, District Superintendent of Illinois, reports traffic very light all over the District. The dropping out of many prominent relay stations and trouble with QRN is the primary cause, presumably. 9LR is doing very good work on a new DeForest "Midget" set. 9DFF is a newcomer and is rapidly becoming a very good station in Decatur, Ill. 9ASL at Springfield is coming through on spark very well, using tone very much like 5XB. 9DLS is a new one at Mattoon, Ill. He is using a 1 KW but hasn't had a chance to do DX work. 9UK is now proprietor of the Marshall Electric Co., Marshall, Ill. He is only at home on Sundays and so 9UK's traffic is not heavy now. 9VC is about through with spark for the summer and is going to try and gather enough to make up a semi-high power CW set. 9PQ has a few 40 watt tubes which he will probably use for CW during QRN. 9DQY and 9VC at Moweaqua, are planning on erecting a big station out on the edge of town using a vertical fan antenna and 9DYQ's new synchronous gap. 9NQ complains of hot weather and very heavy QRN which cut down his usually high report to 25 messages for this month. 9KL total messages—52. 9ANV, of La Salle, who receives messages from Mars asking what kind of a "boiler-factory" he uses "down here," has left for the Naval Academy at Annapolis and so is out of the game for some time. A steady relayer and a fine fellow. 9ACL is out of the game for the summer, but will be back next winter with both feet, likewise his partner, 9AMK. 9JV, an important link in the short cross-state daylight route will be off until next fall.

Mr. & Mrs. Chas. Candler, District Superintendents of the Miami Valley District of Ohio, have very little to report this month outside of messages handled since there seems very little activity. Xenia is coming to the front with a radio club which expects to become affiliated. 8FT at Troy is back in the game and is doing his usual good work. He reports that 8AIB and 8AEE of Dayton are doing excellent work. No report direct from Dayton this month. I should like to have published in QST a request to all the stations in this district to write to the superintendent and let us know what they are doing. 8ZL continues on the "blink".

H. J. Burhop, District Superintendent of Wisconsin, reports but 42 messages handled in the district, these handled by 9MH, Milton, Wisc. Due to numerous accidents 9ZL has been delayed in getting back in commission.

R. D. McCommon, District Superintendent of Eastern Ohio, reports he has been operating 8BDP and has handled a number of messages at this station. 8FD is opening up with a 100 watt power tube set and hopes to be in better position to handle traffic than heretofore.

M. W. Hutchinson, newly appointed District Superintendent of Northern Indiana, has undertaken to carry on the work started by Mr. H. H. Moore, his predecessor, and is handling his District in fine shape. He has appointed Mr. E. E. Pippinger of Goshen as his assistant. Mr. Hutchinson advises only two reports received, from Fort Wayne and from Goshen. Messages handled by 9ME, 46. He reports that he is having a little trouble with some of the fellows and that they do not hand in any message totals to him. 9ME is doing good DX work at present and has little or no difficulty in getting his traffic off. 9DAX and 9PC are unreliable and 9AKH is out of the game at present. Detroit messages can be cleared without any trouble. 9ME is working on a CW set. Messages handled by 9FS, Goshen, 87. He reports that things are going about as usual and that good work is being done at times when the static is not too bad. He has been clearing traffic to 9AAW at noon without difficulty. 9FG and 9ALY have not been in operation for some time.

MID-WEST DIVISION

L. A. Benson, Mgr.

During the past month little or no DX work has been accomplished. Throughout the division QRN is in its prime. The short-jump policy is being adhered to and day-light traffic moves with some degree of regularity in spite of QRN. Very few reports from district superintendents have been received. It seems that they are either out on a fishing trip or tearing down the old apparatus and getting ready for the coming season. A few C.W. stations are still sticking to it and can be heard off and on through the terrific QRN.

Geo. Turner, 9ZAD has won the hand-painted Audion Bulb for writing the longest report. He is still continuing his ups and downs with the local Light Company and rumors are about that he has given the manager a good shot of moon-shine, and since, the line voltage has been around 115 and things are getting along in great shape. Turner says, "you tell him moon-shine, I can't keep still."

O'Rourke of Omaha must have a drag with the Government radio station in his vicinity as he states he is now using a SCR-67 Radio-phone and has been reported QSA in N. Platte, Nebraska and Chicago. O'Rourke is getting into the sleepless wonder class as he says he will continue to

maintain a mid-night until day-light schedule and also reports that 9DIT of Omaha has a C.W. set in operation and has succeeded in handling much of the Omaha traffic. 9VE and 9EW are also on the job. No word has been received from O.M. Stover of Iowa City. He probably is out on another fishing trip as we have heard that he has a record for catching the largest fish in Iowa.

9ZB and 9LC have been handling the bulk of the traffic through the state of Missouri using C.W. and radio-phone.

Haddaway of St. Louis, the home-made tube specialist, has just perfected a new transmitting Tube which he calls the "coffin" tube. He says that these tubes are rated at 5 watts but deliver about 25. A letter to the Division Manager was received from a New York amateur asking how it was that 9ZB could be heard all over the country using two 5 watt Tubes. Sh----- they must be "coffin" tubes.

No detailed information is at hand regarding the number of messages handled and the busiest station.

NORTHWESTERN DIVISION

R. T. Galyean, Acting Mgr.

Re-organization of the Northwestern Division is progressing nicely and a number of new Dist. Superintendents and Traffic Assistants have been appointed in Washington and Oregon. In the eastern part of the Division, Cutting, A.D.M., has made a number of changes in the personnel and appointed several new Dist. Supts. In Idaho, Mr. E. O. Selby, operator of the Boise High School station, 7YA, has been appointed District Supt., and we expect more complete reports from that most important point of our Northern Route to the east.

Although there has been an increase in the number of messages handled in the Seattle District during the past month, difficulty has been experienced in putting some of the traffic thru. Summer static is at its height and often it is necessary to turn off the amplifiers and go down to one tube in order to be able to keep on the fones. Traffic is greatly handicapped by the intense local QRM which is on the increase in Seattle and Tacoma. Seattle traffic has been cleared during the past month with 7FI to the east, 7LS to the north, 7ED and 7ZJ of the Portland District and 6AFG, 6OH, 6HC in California. 7BK of Seattle continues to clear the bulk of the traffic. 7AC, an old timer, is back on the job in Seattle and has been taking an active part in relay work.

In the Tacoma District, 7CE, 7BA, 7BC, 7CB and 7KM have been keeping their hooks clear. 7BA and 7KM are both reported very QSA in Portland, a most difficult place to get thru to most of the

time. 7YS has installed a radio-phone and is carrying on extensive tests with the airplane fleet at Camp Lewis.

Operation at 7YA, Boise, Idaho, has been broken up by the closing of school, but communication has been quite regular with the western stations—especially 6ZR. Traffic to the east has been held up much of the time by QRN which has been very bad every night this month. 7FT at Kuna, Idaho, is off the job for the summer and will give his station a complete overhauling. 7LN at Nampa, Idaho, is getting good results, but is not on very regularly. Nearly all traffic thru this District is handled by 7YA.

At Portland, 7ED has been handling the bulk of traffic this month. 7DA, assistant superintendent at Portland has been off the job for some time owing to the building of a new antenna and some other improvements to his station. 7XE (ex 7ZI) is doing some very fine work with his ten watt CW set. His voice has been heard by a ship 1400 miles north of the Columbia River. 7BP and 7BJ are out of commission owing to the operators holding down cannery stations for the summer in Alaska.

7CN at Marshfield, Ore., is breaking thru in fine style. He has been appointed Dist. Supt. 7HN is beginning to be heard in Portland and is in constant communication with a number of Sixes. Efforts are being made to line up that long-looked-for day-light route to Seattle. We are still hoping that, with the coming of fall, this route will prove a reality.

Arrangements for broadcasting reports of stolen automobiles for the Portland police department have been completed and this service started June 20th. The report is sent out as a QST by 7DA at 9:30 P.M. on spark at 200 meters, and is immediately repeated by 7XF on CW at 260 meters. The D.M. is also putting this same matter before the Police Department of Seattle and it is hoped that we will also be able to have auto theft reports from a number of Oregon and Washington cities soon.

The busiest station in the Division this month was 7BK who handled a total number of 119 messages.

PACIFIC DIVISION

E. G. Arnold, Asst. Mgr.

There has been very little long distance work in this division the past month, compared to other times, as the regular summer QRN has set in. It is true that there are a few that are getting through at times, but very unreliably in the handling of traffic.

Most of the traffic that is getting through now is being made in short jumps. Traffic is being handled along the coast in a fairly reliable manner, the main

difficulty being to get the traffic through to the east. The old reliable 7YA is heard but very seldom now and the only other outlet is through 6ZH and 6ZJ, both of Richfield, Utah. 6ZX of Walnut Grove is still handling the greatest number of messages. He is working straight through to 6ZH. The returning traffic is then sent from 6ZX down the coast via 6IM of Vallejo, 6JM of Napa, to 6DP, 6AAK, 6KP and 6ZN, along with others.

It is peculiar to note that traffic from the Bay cities going south has an altogether different routing. From San Francisco via 6HC, 6TV, 6VX, 6DP direct to their destination.

The only high powered special licensed stations that are getting through now are 6ZN, 6ZR, 6ZAA, and 6ZX. We are glad to report that our manager Mr. A. E. Bessey, of Sunnyvale, is now back on the job with a beautiful roaring 120 cycle synchronous set.

Every A.R.R.L. man is requested to keep a record of the number of messages that he handles every month. A number have been neglecting to do this and it is a matter of vital importance. Now fellows, let's start today and send those reports in. Reports should reach the Manager by the 15th of each month.

All amateurs in this division who have not written the relay official in their section will profit by doing so. There are any number of vacancies on all the trunk lines going through this division. All these reports should be sent to Radio 6ZAA, E. G. Arnold, 49 North 15th Street, San Jose, Calif.

DAKOTA DIVISION

Boyd Phelps, Mgr.

We hate to admit it but radio is weakening this summer. Not that the nights are all filled with QRN but because it has been so blamed hot that most everyone stays out of doors evenings or beats a retreat for a summer resort. The stations that are on the job find many nights when they get out in good shape but not many such stations are to be found on the job. A few eastern CW stations come thru several nights each week and the best of the closer spark stations.

Mr. Gjelhaug, 9ZC, D.S. of Northern Minnesota, offers the suggestion that if clubs would build portable sets and take hikes or rides out of their cities to nearby lakes it would be a fine thing to hold the clubs together. Something on the order of a week-end picnic with radio and other sports combined. This seems to be an excellent idea and should help to keep interest up and do away with the general reorganizing necessary every fall in clubs that close for the summer. Clubs are apt to forget the value of some social gather-

ings in addition to the technical discussions.

Short jump routes are being tested as fast as developed and clearing schedules arranged at 12:30 P.M. for most stations. So far the north and south route has not been open all the way at the same time but before the summer is over it is expected that schedules can be arranged convenient for all. Unfortunately we have lost 9XI and 9YAF for the summer, 9YAF being our best jump from the U.S. to Canada. 9YAC has not quit and swears he will not. He has found some surprises in store for him now that he is tinkering with CW and handling traffic with it.

No reports were received this month from North Dakota or Southern Minnesota. Many stations are being overhauled completely so we can expect some new sparks in the fall.

ALASKAN DIVISION

Roy Anderson, Mgr.

It appears that there are several good stations in British Columbia and it seems that it would be entirely possible to establish a relay route south from Ketchikan to the States via B. C.

From advices received it also seems possible that a good relay route could be established eastward thru Canada. However, to locate the stations with the right kind of operators is a thing that cannot be done overnight. This is because some of the operators are not able to be at their stations with any degree of regularity and we all know what it would be to have one station off where real good stations are so few and far between.

The writer believes, however, that it will not be necessary to depend on a B. C. route, because it is possible to carry on direct communication over much longer distances than the one in question, with less than 500 watts, even; however, it would be convenient to have an "emergency route".

Mr. Geo. Sturley, a commercial operator, advised the writer that he was installing an amateur set at Chignik for his own use during the summer and that it was then to be turned over to the postmaster at that place. In Chignik Mr. Sturley is able to hear many 7's and some 6's, so why won't they hear him?

Mr. McCue, 7IP, advises that old 7IP, the spark, is no more, and that he will put in a good C.W. set with which he hopes to reach the States.

ERRATUM

In Mr. Whittier's C.W. article in the last QST, in the lower right-hand corner of page 28, the value of grid leak used for two 50-w. tubes on 1000 v. was given as 250 ohms. Mr. Whittier advises us this is in error—it should read 2500 ohms.

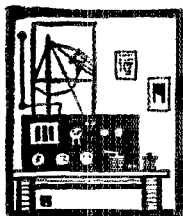

Amateur Radio Stations

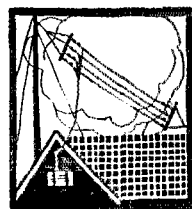

1BDC, Ex 1GBC, Southbridge, Mass.

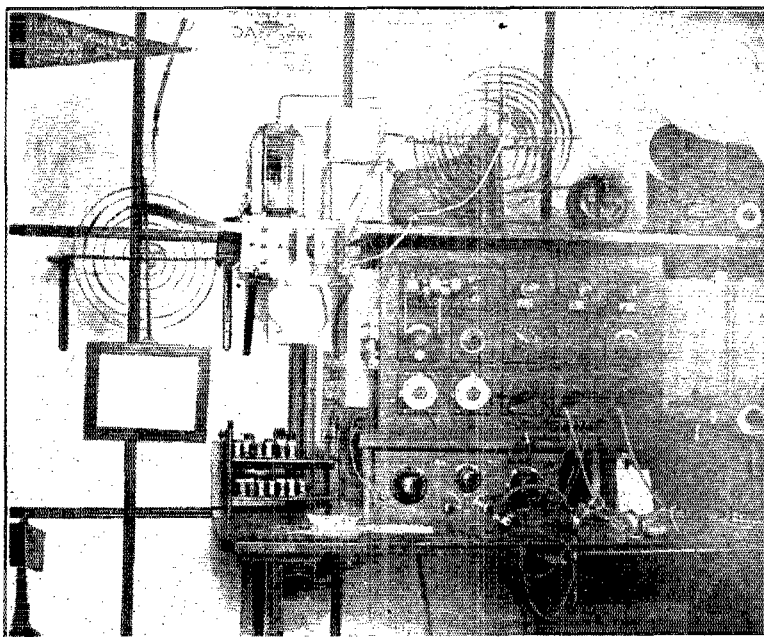

1GBC, operated by Mr. Wm. E. Arnold, is one of the newer A.R.R.L. stations in New England, and bids fair to solve some of the transmission difficulties in the hilly country between Boston and Springfield.

Mr. Arnold's aerial is an 8-wire cage, 4 ft. in diameter, 61 ft. long and supported 60 ft. high at each end, with an 8-wire cage lead-in 8 inches in diameter. This is an aerial of which any amateur may well be proud.

The transmitter uses a 1 k.w. type RS Thordarson, special Dubilier condenser, belt-driven Super-Benwood rotary, and home-made pancake O.T. and antenna loading inductance. With eight inch coupling the antenna current is 4 "Jewell thermocouple amperes." 1GBC is beginning to reach out in good style.

The receiving equipment consists of a 15-panel deForest set with two steps of a.f.

amplification, also a Grebe CR-3 short wave regenerator, a home-made 8-pole D.P.D.T. switch connecting the tube equipment and primary condensers to either tuner, Western Electric and Brandes phones, and a loud speaker made from one Baldwin type E receiver and a 22-in. horn.

Mr. Arnold is secretary of the Southbridge Radio Assn. and will gladly cooperate with other associations in radio matters.

5ZG, Dallas, Tex.

5ZG, a photograph of which appears on our cover for this month, is the station of Ben Emerson, 3730 Wendelken St., Dallas, and has become very well known of

late thru the good work that has been done by its phone set in publicity undertakings under the auspices of the Dallas Radio Club.

The spark set consists of a 1 k.w. old-style Thordarson, six sections of Murdock moulded condenser in parallel, an open non-synchronous rotary, and a home-made pancake oscillation transformer. Wave lengths of 200 and 375 meters are used, at which the antenna current is respectively 2 and 3¼ amps. The aerial is an inverted L, 60 ft. high and 60 ft. long, of 7 wires spaced 2½ ft., lead-in wires bunched immediately under the spreader.

The range of the spark set is about the average; as Emerson puts it, a thousand miles when a thousand miles isn't wanted and 150 under ordinary conditions. Its signals have been reported from Fall River, Mass.; Baudette, Minn.; San Francisco; and Havana, Cuba. Seefred Bros. are our authority for saying that this station participated in the handling of the first amateur "transcon" that ever came from the Pacific Coast.

The receiver comprises an old-time Paragon RA-6 and a home-made cabinet containing a circuit for honeycomb coils and a detector-two-step, the tube equipment of which may be used with either the coils or the Paragon.

On the extreme left of the table is the motor-generator for the C.W. set, which appears next to the right. This set uses four 5-watt Radiotrons, two as oscillators and two as modulators, and is copied from the article appearing in QST for May, 1920 (i.e., it uses the Colpitts oscillating circuit and constant-current modulation). The normal antenna current is 975 m.a., and can be crowded to slightly better than 1 amp. Voice and music have been heard in Little Rock and at a point 200 miles west of Dallas, and C.W. signals have been reported from Des Moines.

Under the auspices of the very-live Dallas Radio Club, numerous demonstrations have been staged in which 5ZG took a leading part and much good work for Citizen Radio has resulted. This station recently furnished bulletins of returns for a local election, which were put out at a street fair thru a large-type Magnavox and could be heard five blocks. The mayor-elect later addressed his townfolk by the same means. Music by the same set was supplied a Shrine ceremonial as told elsewhere in this QST, and has been success-

fully transmitted to dancing parties at various points some twenty miles away.

Mr. Emerson is shown seated at his set. He was born in 1887 and caught the radio bug from Division Manager Corlett, old 5BJ, now 5ZC, in 1915, pre-war 5DU being the result. He served in the U.S. Navy from 1905 to 1911, being discharged as

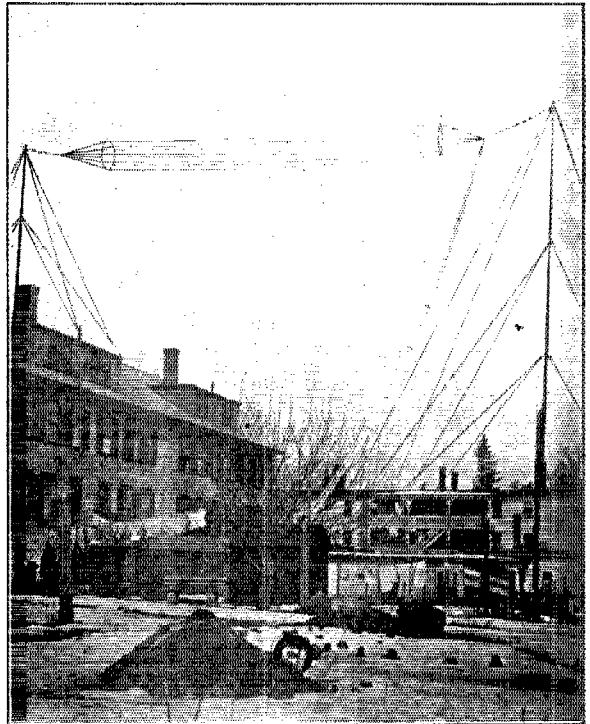

The Aerial at 1BDC.

Seaman Gunner 3d class, and is at present Assistant Automatic Chief in the multiplex department of the Western Union in Dallas. Ben is married and has two bugs, Ben Junior and Kenneth W., the latter having been named after the Editor of QST in token of a friendship made years ago when the Editor, then 9JT in Illinois, was the first DX station to report the signals of 5DU.

7YS, Lacey, Wash.

7YS is one of our best stations in the northwest. It is located at St. Martin's College, Lacey, Wash., and operated by Rev. Sebastian Ruth, who has long been a radio amateur. We have no details of the outdoor equipment but can get a good idea of the apparatus from this photograph.

The short wave receiver and detector-two-step are the product of the Radio Shop, of San Jose, Calif., while above and between them a honeycomb long wave outfit is mounted, with its two condensers set into the table in the foreground. The

Murdock, the enclosed rotary is home-made, and the condenser is an .01 mfd. Dubilier.

All the big stations in the world, from Germany to Java and from Panama to St. Paul's Islands, are copied on the long wave

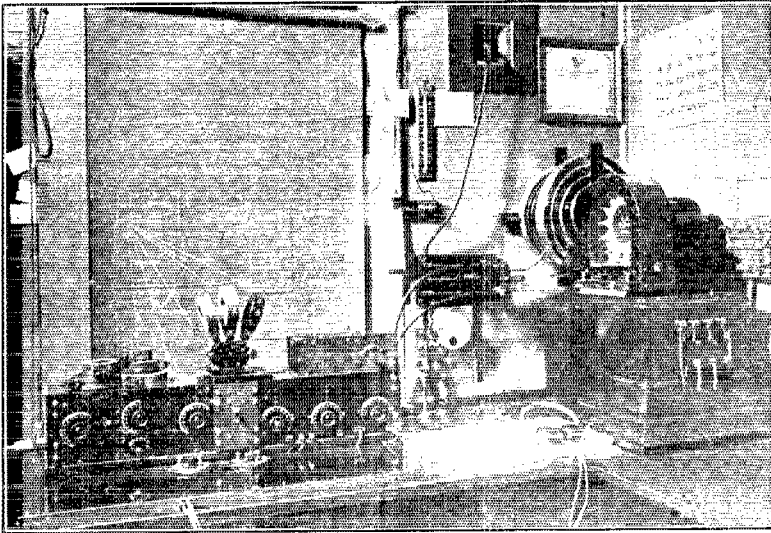

telephone switch on the small panel directly under the honeycombs connects the tube equipment to either set.

The transmitter is neat and well arranged. The transformer was made by

outfit. 7YS has been heard by three amateurs in Kansas and also by the operator of the S.S. "Hollywood" while that vessel was three hundred miles east of Honolulu, a distance of about 2000 miles.

2XX, Ossining, N. Y.

Here is the private station of Mr. Robt. F. Gowen, radio engineer for the deForest company, located at his home in Ossining. This is the station that recently transmitted the famous vaudeville program rendered by the Duncan Sisters—an entertainment that will long be remembered. All of the equipment, described below, was designed by Mr. Gowen, who states that the only trouble he has found with it is that he has no time to operate it.

As will be seen by the photograph the 1921 edition of 2XX is a decided improvement over the arrangement illustrated in the May number of QST last year. Several novelties are shown which have worked exceedingly well under operating conditions. The receiving loop indicates progress in keeping up with the very latest ideas.

Two aerials are now used at 2XX, one of which is last year's aerial cut in two by breaker insulators in the centre of the flat top. This has reduced the fundamental from 385 meters to 280 meters.

This change was made in order to get greater efficiency on the 400 meter demonstrating wave length now used instead of the 750 wave length employed last year. By this change the capacity was reduced from 1020 mmfds. to 670 mmfds. The other aerial is a four wire inverted L for transmission on amateur wave lengths. It is much lower than the large antenna and is placed at right angles to the former in order that it may be used as a receiving aerial for duplex work. It has a fundamental of 210 meters and a capacity of 480 mmfds.

The transmitter shown at the right is the latest model deForest 1 kilowatt set, type OT-201-C. This is a development of the type OT-200 transmitter used last year in the long distance record work done by this station. Two one-half kilowatt Oscillon tubes are used. The modulation is accomplished by means of the same type circuit as in the OT-200 set where what it known as a "kicking coil" is used to modulate both the grids and plates simul-

taneously. Automatic switching from transmitting to receiving is accomplished by an electric relay antenna switch in the rear of the panel controlled by a lever switch in the handle of the microphone. The transmitter consists of two distinct panels mounted one above the other. On the back of upper panel is mounted the helix, condensers and chokes for the oscillating circuits while the rear of the lower panel contains the filter circuits, etc., together with the field regulators and switches for the control of the power plant.

The equipment shown in the cabinet on the operating table consists of three receiving units, a small radiophone employing two E tubes for duplex work, and an aerial distributing panel unit. The top of the cabinet is hinged in order that it may be raised to get at the wiring on the back board in the rear. Binding posts for each unit are mounted on bakelite strips attached to its base so that no binding posts or wires show in the front. The leads to the binding posts are flexible so that each unit may be tipped forward by pulling out its top in order to change tubes or get at the wiring if necessary. The units are separated by partitions consisting of nickel plated square brass rods attached to the base and back of the cabinet.

On the extreme left is the B battery panel, behind which are placed eight 22½ volt block batteries, connected to the switches shown so that voltages for any desired purposes can be obtained. On the right of the B battery panel is located the detector and two stage amplifier. The tubes and amplifying transformers, which are Western Electric, are placed behind the panel. The centre panel comprises two distinct tuners. The Honeycomb coil tuner on top is suitable for any wave length and the variometer type regenerative receiver below it is designed for amateur reception on wave lengths between 180 and 450 meters. This is used primarily for work with the receiving loop where a tuned plate circuit has been found advantageous.

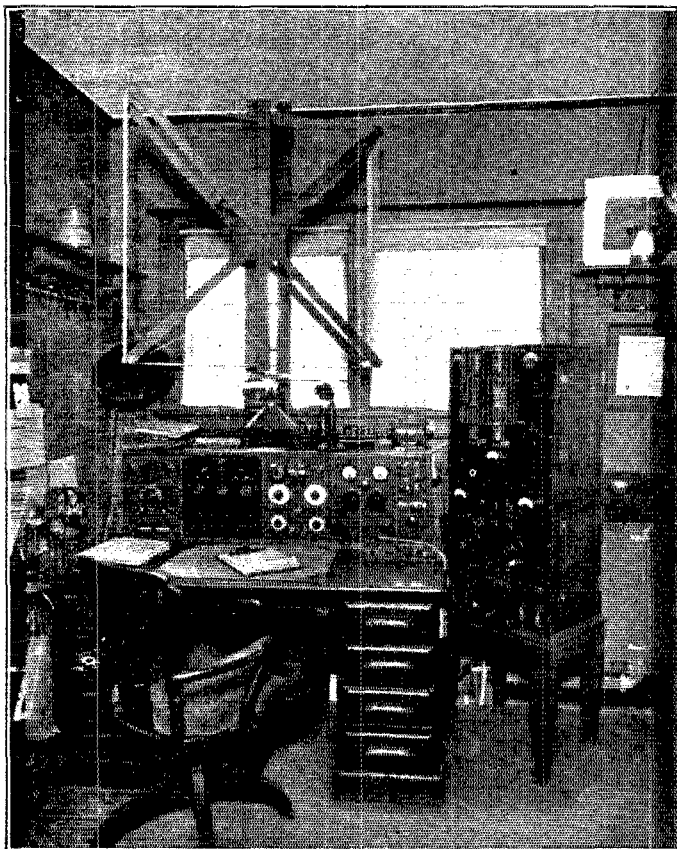

Honeycomb coil type variometers are used and switching from one tuner to the other is done by means of the three small switches shown on the panel. With these switches also the variometers may be placed in series with the secondary and tickler inductances of the Honeycomb coil tuner while the vernier condensers are in circuit at the same time. This combination provides a remarkably flexible outfit, excellent for experimental work and yet entirely practical for DX consistent operation. The small radio telephone shown to the right is one of the two instruments designed for duplex working. It uses the Western Electric circuit, described in a recent issue of QST, with inductive coupling to the aerial by means of a variocoupler.

Two methods of working duplex are used. The small transmitter may be used on the small aerial while receiving is done on the large aerial or the receiving may be done by means of the loop which is plugged into the coil mounting of the tuner instead
(Concluded on page 56)



Nola Radio Club

Our last meeting proved a surprise to all, both in point of attendance and interest. We have overcome what we think is a great obstacle to the advancement of some radio clubs, viz., interest in club activity. Our members seem never to lose their interest in the club and we point with pride to the fact that every member enrolled during the past season has attended every meeting held since his enrollment. And this without exception. At our last session we elected new officers for the coming term as follows:

President: J. Bastian

Vice-Pres.: B. Mannard

Sec.-Treas.: J. Reuning

Publicity Manager: C. J. Delaplaine

It will be noted that a new office was created, that of Publicity Manager. This was done in order to relieve the Secretary of the burden of making publicity reports, propaganda, etc., in addition to his regular duties, and for clubs doing any amount of business at all we think such an office would prove of great value. This officer also acts as an assistant to the Secretary-Treasurer and it is part of his duties to get out and enroll as many new members as possible, and to bring before the amateur the fact that a going organization is awaiting his aid and co-operation in bringing about a more perfect condition relative to operating, QRM, etc.

The new half kilowatt transmitter arrived and is a dandy outfit. It is a commercial set of the panel type, with meters, quenched gap and controls mounted in front and M-G, O.T., Condensers, etc., conveniently arranged in the rear. This set afforded boundless interest when it arrived and already has proved a valuable asset in its powers as a "drawing card." This brings our equipment up to that point necessary to the advancement of the up-to-date radio club, and we are confident of our ability to hold the attention and interest of all experimenters and operators who desire to join hands with us. We have no age limit and the only qualifications necessary are an interest in radio communication and a desire to abide by our regulations. Application blanks may be secured from the Secretary-Treasurer, 134 Chartres Street, New Orleans. No initiation fee is charged and the only expense attached is a small

monthly due. We are getting stronger every meeting and would like to correspond with anyone interested. Correspondence from other clubs is especially invited and all letters will be promptly answered.

Hudson Amateur Radio Club

At a recent meeting of the Hudson Amateur Club, (New York City) Mr. Israels, chief engineer of the Simon Radio Corporation, gave an extremely interesting talk on modulation of C.W. sets.

The scientific committee is planning many new interesting features among which are talks by prominent radio men.

The Hudson Amateur Radio Club has been in existence for four months and is composed of about thirty members, almost all being licensed amateurs. So far the meetings have been held at the homes of the members but an attempt is being made to find a club room with suitable facilities for the installation of a club station.

The club would be glad to hear from any like organizations. Kindly address all communications to Samuel Jackson, Jr., secretary, 345 West 88th Street, New York City.

Fordham Radio Club

The Fordham Radio Club was organized November 6th, 1920. At that time conditions in this section of the city were reaching the point where constant communication between stations only a mile apart could barely ever be maintained because of the incessant roar of local interference, a large part of which was unintentional. The pressing need of immediate organization to correct a condition that was destroying amateur radio in this district was recognized by a few of the more advanced men, and the result is the present Fordham Radio Club.

We have now as our primary object, the establishment of the "CW" transmitter as every amateur's sending set. That our progress in this direction has been great is evidenced by the fact that at every meeting we are enrolling new members in the "CW" Chapter, and we are now reaching the point where a spark transmitter in our vicinity is becoming a rarity, partly because of its unpopularity, but chiefly because our members recognize the extremely

high relative efficiency of the continuous wave transmitter.

Those in and around the Second District, who are hearing 2XK, 2BNL, 2ACT, 2QK and others regularly do not have to be apprised of the good work we have already done.

Meetings are temporarily being held at the home of Mr. L. M. Cockaday, 2XK, 2674 Bailey Ave., Bronx, every Monday night at 8 P.M. As yet we have been unsuccessful in locating a desirable meeting room where a radio station can be installed, and would appreciate a word from anyone knowing of any such available space.

The club is of course open for membership and we take this opportunity to extend a cordial invitation to all interested in radio to attend our meetings at the above address. Communications are invited and should be addressed to Mr. Richard Leitner, 1113 Forest Ave., or to the Secretary, Mr. William Weller, 2156 Webster Ave., Bronx.

So. Jersey Radio Assn.

Monthly meetings of the South Jersey Radio Assn. are held on the third Thursday evening of the month, in the mayor's office, Collingswood, N. J. Interesting talks are given each meeting, and visitors are welcome.

The Radio Engineering Society.

The Radio Engineering Society of Pittsburgh (Pa.), the leading club in that city, continues to grow and has interesting meetings to which visitors are invited. Technical papers are read at each meeting and prominent engineers from the Westinghouse company are always in attendance.

The club is now arranging for its Third Annual Outing which will be held on August 6th at "The Pines" a resort a short distance from Pittsburgh. The program includes exhibitions, contests, technical discussions, a chicken-waffle dinner followed by talks, and dancing by radio music. Everyone interested in radio is invited, and would do well to communicate with the club at once for reservations.

Exhibit at Flint, Mich.

On June 9th and 10th Flint had its first radio exhibit, the occasion being the annual High School exhibit. Local amateurs contributed to the success of the affair, a set being installed over which regular phone communication was had with 8YG at East Lansing and 8ADY at Fenton. Hundreds of visitors were delighted with the radio music and for the first time heard "our gang" pounding away on 200, heard commercials, navy arcs, and the big fellows across the pond.

A questionnaire is being mailed amateurs in the vicinity of Flint with a view of

forming a radio council to improve conditions. Officers will be elected by popular vote of course, but meanwhile someone has to start the ball rolling, and they are: Guy R. Cowing, F. D. Fallain, E. H. Brockway, C. F. Valentine, and Thos. Lathrop, all prominent in radio circles in that vicinity. Correspondence is invited.

Fort Worth Radio Club.

The Ft. Worth (Tex.) Radio Club was organized last August, and radio in and around Ft. Worth has been steadily developing since that time. Y. M. Cornelius has been president of the organization since its formation, Melvin Smith is the present vice president, and Prof. Oba R. Garrett of Brantley's College is secretary-treasurer. 5LC and 5MN are the best local stations and will handle traffic for Ft. Worth or QSR. The present membership is thirty.

Meetings are held in the telegraph department of Brantley's College on Thursdays at 7:30 p.m. Anyone interested is welcome except on business nights, the first Thursday in the month. The club would be glad to communicate with other organizations.

Dallas Radio Club.

The Dallas Radio Club continues its splendid activities. On April 30th radio music was delivered for the assembled Nobles and Novices preceding the ceremonial work of Hella Temple A.A.O.N.M.S. at the Coliseum, Fair Park. The club is averaging a demonstration a week and if interest keeps up as it has started they promise to have the Texas prairies cobwebbed all over with aeriels. Plans are under way to transmit sermons to patients in hospitals and others unable to attend church.

Western Mass. Executive Council.

QRM has long been rampant in Western Massachusetts and in order to improve operating conditions a meeting was called with three representatives present from each club in the territory. The title Western Massachusetts Executive Radio Council was adopted, and A. S. McLean, A.R.R.L. District Supt., elected chairman and Geo. Marois of the Springfield Radio Assn. corresponding secretary. Traffic rules were discussed and the following drawn up:

8 a.m. to 11:55 a.m., free air. 11:55 a.m. to 12:05 p.m., QRX for time signals. 12:05 p.m. to 4 p.m., DX with privilege of local work if air is clear. 4 p.m. to 7 p.m., free air. 7 p.m. to 9:30 p.m., local work only, with QRX for phone. 9:30 to 9:55 p.m., inter-city. 9:55 to 10:05 p.m., QRX for time signals. 10:05 to 10:30 p.m., inter-city. 10:30 p.m. to 8 a.m., DX

(Concluded on page 51)

Strays

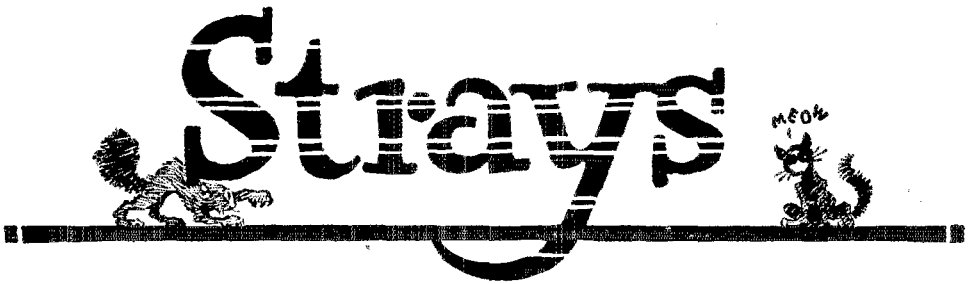

For a vernier adjustment of tuning controls when copying C.W. or working at critical regeneration, try this: do your copying with a lead-pencil having an ordinary rubber eraser worn slightly conical; by placing the rubber in the angle between the periphery of the rotating control dial and the panel, any point where convenient around the dial, and turning the pencil between the fingers, the most exact adjustments can be secured and, because the fingers are farther away, capacity effects are greatly reduced.

Wm. Warden, 4AM, one of the fellows to open up relay work thru Florida, ordered an old-style AudioTron four years ago. It was overlooked when it arrived and got sewed up in some excelsior in a porch cushion. Everyone noticed the cushion had a tinny sound when shaken and finally Kid Brother opened the cushion to find the Tron in good condition. It was used in the recent relay work.

All the porch cushions in the U.S. are now in danger of incisions.

—Reported by SUX, QST's cartoonist.

In addition to uncrowning a genius out Omaha way recently, they found one up in Woodstock, Ont. The latter's crime consisted in inviting some visitors to his station to hear KDKA. Something must have gone wrong with his grid-leak or something, because one of the hams heard some loud music in the cellar of his building and peeked thru a window to find an old phonograph grinding away merrily with a Skinderviken button on its tone-arm. He gets this write-up not only on account of the above but because he has done his best to prevent the formation of a radio club in his city.

SAFA reports that after struggling with a receiving set that gave poor results he became suspicious of the presence of "Nokorode" soldering paste which had spread in a film over the panel in spots, from the heat of the iron. It seemed to have formed a leak across several of the connections and its removal solved the trouble. So neat soldering is advisable from the standpoint of electrical efficiency as well as workmanship.

Lorimer wants to know if the initials of N. C. Bos, reservation manager of our coming national convention, stand for "National Convention Boss". Hi!

Renville H. McMann, of New York City, who is a member of the Second District Executive Radio Council and secretary of the Radio Club of America, has been appointed manager of the radio department of the Federal Telephone & Telegraph Co., of Buffalo.

The Dallas (Tex.) police radio system scored a success early in June when description sent out from its station led to the arrest in Mobile, Ala., of a burglary suspect badly wanted in Dallas.

At a convention of the International Assn. of Chiefs of Police at St. Louis recently, Chief of Police James W. Higgins of Buffalo spoke on "Wireless Telegraph and Telephone as a Means of Imparting Police Information", and described the installation and work in his city. As a result a resolution authorizing the president of the organization to appoint a committee to develop a uniform system for radio police work was adopted unanimously.

With appreciation the Editor acknowledges receipt of one of T.O.M.'s power tubes, designed and constructed by Prof. O. Nicholson of 7KM. Unfortunately our photo of it did not come out well, so we must content ourselves by saying that it consists of the usual three elements, of unusually sturdy construction, mounted within an octagonal-section Heinz pickle bottle, with the usual four prongs protruding thru the cork, which is carefully sealed in with paraffine to retain the "vacuum". Heavy fines are mentioned for infringement of this design, and none are genuine unless they bear the Heinz "57 varieties" label.

No doubt many amateurs remember having heard 2XAC on his concert nights on 400 meters. This station is operated by J. B. Ferguson, general construction manager of the Ship Owners' Radio Service, Inc. A special concert given by the Noxola Syncopaters on April 26th jazzed the

ether for the benefit of ships at sea, and was heard by vessels 200 miles off the coast of France, it is reported.

Wouldn't it be Wonderful—

If some inventive genius would get out an air-cushion to put under your left elbow when tuning a regenerative receiver?

If 8LQ and 8ML would stop using a perfectly good whisky still for an oscillation transformer?

If 9KF would get a better piece of galena?

If 8SP would stop signing 9SP!

If 9ATP would recognize that Continental is the code we amateurs are supposed to use?

If NAM had to listen to all the mess he sends out?

If ship operators complaining about not hearing NAM on 600 meters would tune down to 200 meters?

If 9JN got a regular key?

If you could only hear someone when you invite the neighbors in?

If 8DZ would learn to spell "electrolytic rectifier" without having to stop and write it out on paper?

If a certain New York editor would build that war machine he took subscriptions for?

TO T.O.M. AND T.Y.S.

There is a guy called "The Old Man,"
Who knows nothing else but to "pan,"
Says we are all rotten,
Seems to have forgotten,
Himself was once naught but a ham.
There is also a fellow named "Squirt,"
Whose chief job is slinging the dirt;
He regards all with scorn,
Loudly toots his own horn,
And believes that he owns the whole eart'.
There are times the Old Man hits the mark,
But mostly his gap does not spark;
For we're not all rotten
From top to the bottom—
And his bite's not as bad as his bark.
This bird, The Young Squirt, gets my goat;
I don't think his motor can mote;
He raves about dreams
Till some times it seems
That one of them stuck in his throat.
Oh, knockers we ever will see
In this land of the brave and the free;
But could we make boosters
Of these two gay roosters,
What a wonderful thing it would be.

—A. H. Benzee.

The "Denver Post" recently treated western amateurs to a concert by Miss Frieda Hempel through station 9XAG owned by Mr. H. H. Buckwalter. The Post played up the story prominently as a radio treat for its many radio readers in the western states, and many family parties were held at which it is estimated

at least 5,000 persons heard the singing of the world-famed diva.

In Mr. Anderson's letter on page 60 of April QST the distance between Prince Rupert, B.C., and Ketchikan was mentioned as 20 miles. This is an error—the distance is 90 miles.

On April 19th the Oakland (Cal.) Tribune conducted what is believed to have been the first amateur radio press service ever undertaken by a newspaper. This was done with the co-operation of the Bay Counties Radio Club and was entirely successful. 6PR in Santa Cruz, 6ZR in Burlingame, 6JF of Hayward, 6IM at Vallejo, 6HP of Richmond, and 6AJ of Mundt sent local news which was copied by San Francisco stations and published as a radio corner in the Tribune. Great interest was shown in the affair and it is probable that a test of wider scope will be undertaken soon.

Improbable Story Beginnings

By Arthur K. Ransom.

(Apologies to the N. Y. Herald)

"Why certainly, young man" said the landlord, "you may put up as many aerials as you want. I like the looks of an aerial and besides it improves the appearance of the building.

"If this tube burns out be sure and bring it back and I will give you a new one for it," remarked the salesman as he wrapped up a "U" tube.

2BGA called a station three times, signed three times and waited for an answer. None came so he desisted from further attempts.

Because his wave was four meters in excess of the legal limit, Willie decided to use an antenna series condenser.

A message started from New York one evening reached San Francisco and was delivered the next morning.

"There is nothing rotten in radio," remarked T.O.M., "and I shall write no more articles for QST".

"If I cause any interference on 200 meters," transmitted NAM, "I will gladly QRT if requested."

"I have decided," casually remarked 2OX, "to buy a new rotary gap and to go to the Radio Institute for code practice."

The Electric Co.'s collector presented a twelve dollar bill for payment. Willie, counting out the pennies, remarked that "radio would break him". A sudden change came over the collector's face. "Oh," he cried, "I did not know this was a radio station. There is no charge for current used in this noble work." And he wrote out a receipt.

"No," remarked He to She, "I can not call on you this evening. I must devote my time to radio." (2WD and 2AB please note.)

National Radio Fraternity Organized

Alpha chapter, Alpha Delta Alpha radio fraternity of Coe College, Cedar Rapids, Iowa, announces the affiliation with the installation of Beta chapter at the State University of Iowa, Iowa City, Iowa.

Alpha Delta Alpha radio fraternity was founded at Coe College in September, 1920, by eighteen commercial radio engineering students. After being granted a charter by the college, Alpha chapter was legally installed the following month. There is a present membership of twenty-five. From the very first the organization has been marked by a spirit of enthusiasm and co-operation which has had very marked results.

The nationalizing and establishment of chapters in the universities and colleges of the United States marks the establishment of a new type of fraternity which should prove very popular. At the present time a number of petitions from some of the leading universities of the Middle West have been received by the fraternity, and very likely other chapters will be installed in the near future.

Wouldn't it be wonderful if Cuba sent drinks by wireless?

At the recent opening of Hartford's new municipal aviation field, celebrated by a flying meet, the C. D. Tuska Co. provided telephone service between the city and the field, some miles out, by radio between a temporary station on the field and 1XV, the Tuska station in the city, the latter being linked to the local phone lines. Perfect speech was obtained, and the installation added much to the convenience of the fliers and officials.

2KT, Polytechnic Institute of Brooklyn, 85 Livingston St., is open to amateur traffic 1 p.m. to 7 p.m. daily except Sundays. A $\frac{1}{2}$ k.w. spark set is used, wave 208 meters. Since there are few stations operating in daytime, 2KT may be watched for in daylight work as a good New York relay terminal.

Noisy
As
Hell

3ZL is handling government traffic with the "Eagle 9" (NEJM) on trips up and down the river from Richmond.

In a list of "calls heard" in one of our esteemed contemporaries we note, among others, the call " $\frac{1}{2}$ AFN". If this is a call, where is this bird located? Our book doesn't show him. Maybe it means he's only using half power. Maybe there are some " $\frac{1}{4}$ " guys around, but if it's figured on a mental basis, "Romeo" says there are a lot who should sine zero.

9FQ and CQ are still clearing each other regularly. Judging from the long calls however 9FQ seems to be having quite a hard time raising CQ most of the time.

1MD suggests a column in QST devoted to spark coils, where they can publish their records, etc. He has worked 1PAW and 1UN, 30 miles on 18 watts; 1GM, 22 miles on 10 watts, and other respectable distances on low power. F.B.

Paul Oard of Stockton, Cal., recently conducted some successful tests with a receiving set installed in an auto. A conventional two-variometer set was used, with single tube, small flat-top aerial suspended between short masts fore and aft, ground connection to frame of machine, with an aviator's head set used to cut out external noises. All work was on 200 meters, and 7BQ, 7ZI, 6BX, etc., copied with good audibility, these distances being up to 700 miles from Stockton. No difficulty was had in copying up to 100 miles while the auto was making moderate speed, but at high speed magneto noises paralyzed the tube.

More good records:

9LW, Wahpeton, N. D., has been reported very QSA by a ship in lat. 53-19 n., long. 144-18 west, distance 2200 miles.

2ARD, now 6ALE, advises us of the receipt of signals de 2RK at Los Angeles, on a swing-in at 12:33 a.m. April 16th. Mr. Hewitt has confirmed the transmission, which was done on one P tube using a.c. on the plate.

2JJ, Tenafly, N. J., reported heard at 7ZJ, Vancouver, Wash., at 5:55 p.m. Pacific time on Thanksgiving last.

WITH THE AFFILIATED CLUBS

Western Mass. Executive Council

(Concluded from page 48)

only. The morse letter "C" shall be the inquiry call for DX and phone work, and the continental "Y" the "keep out" signal, meaning something of importance coming in. If no answer is received within two minutes, transmission may start.

After two weeks the council met again, the rules being meanwhile put before the various clubs and approved by all, and the necessary arrangements made to put the regulations into practice.

Other work of the Council is to locate and register all stations, and to tune stations free of charge. At the present time the Council represents over 90% of the radio men of the district and all of the clubs represented are affiliated with the A.R.R.L.

Calls Heard



HEARD DURING JUNE Unless Otherwise Specified

Instructions to reporters:

- (1) Typewrite or neatly print the calls, "double-spaced," on a separate sheet of paper, running them across the sheet, not down a column, and writing on but one side of the paper.
- (2) Arrange alphabetically thru each district, from 1 to 9, with no break between districts, using commas to separate items and putting parentheses around calls of stations also worked—all as per the lists below.
- (3) The period covered by the report shall be from the first of one month to the first of the following month. All lists must be received by us the 10th of the second month, for publication in the next following QST.

HEARD AT SEA

The Log of the Return Voyage of An Amateur at Sea—being a continuation of the record appearing on pp 25-26 of March QST.

Feb. 18—825 miles south of Los Angeles, off Ballena Bay Lower California.
 7:30 p.m. 8ZR calling 8ZY QRK
 7:30 8ZY calling 8ZR QRK
 6's, 7's and 5's too numerous to mention
 9LR QSA all evening.

Feb. 19—Peculiar buzz on 200 QRMs everything, and QRN very bad tonight.

Feb. 20—1200 miles south Los Angeles.
 5:00 p.m. 5ZC sent QST QSA
 5:20 5EW very QSA
 5:24 5LR working 5EW Very good
 5:30 5LS calling CQ QSA
 5:31 5JT calling CQ QSA very
 5:39 5CC QRK
 5:58 5ZE very strong
 6:01 5TH very strong
 5ZA very strong

10:30 62N QRK
 10:35 61G QRK
 10:37 5YS QSA
 10:45 9LR QRZ
 10:47 8TK QRK very plainly calling 8ZD.
 10:52 5ZR QSA very and steady
 11:12 5ZX QRK

Feb. 21—1500 miles south Los Angeles
 6:30 p.m. 5ZF very QSA thru heavy QRN
 6:36 5ZS very QSA
 6:37 9AAC QRK
 5LR QRK
 7:05 5XB loudest of all 5's
 8:00 6ZR QRK
 8:01 Some 3 calling 1HAA QRZ. Sounds like 3DH
 8:03 3DH calling 1HAA. ot him fine this time
 8:06 8ZY signing off QRZ
 8:07 3DH calling 8LQ very plainly
 8:08 3DH again, calling CQ
 8:10 3DH calling 8LQ and telling him QRM very bad and CUL—very plain. (Note: we are now same airline distance from N. Y. as Los Angeles to N. Y.

8:10 2RK signing off QSA
 8:25 2RK sending QST bout some convention at Phila. Audible 6 in. from fones but had to copy thru QRN. Had to disconnect ground to get down to his wave.

Feb. 24—540 miles northwest Balboa C. Z.
 11:12 p.m. 8ZR QSA
 Heavy QRN—hard to read anything
 11:55 Long Beach (Calif.) radiophone QRK
 2RK on and off all evening QRK
 12:10 8ZR audible foot from phones, steady for over an hour. Whoever that 3d dist. station is 8ZR is working, is QRK but can't get thru static. Sounds like 3HK. And 8ZR slides over it like he didn't want anybody to read it!

April 1—100 miles north San Salvador
 7:20 p.m. 2DR and 2JU QSA
 8:50 2EL QSA
 11:15 2ZV QSA

April 2—370 miles east of Savannah, 700 south of New York.
 1:45 p.m. 4XB playing music on phone, QRK.
 Between 6 p.m. and 12:10 a.m. copied: 1AW, 1JAP, 1GBT, 2CT, 2JU, 2DA, 2BM, 2AR, 2UK, 2ZL very QSA on CW., 2AJW, 2ZM, 2MG, 2RB, 3BZ, 3XM, 3AHK, 3YK, 3GO, 4ZC, 4GN, 3ZC, 2ABZ, 3ZR, 3HA, 3AL, 3AG, 3ZT, 3KK, 3LF, 9ME.

April 3—500 miles south of New York.
 12 noon 2EL working 2FS, easily readable.
 Between 5:45 p.m. and 11:09 p.m., 425 miles south New York, copied 1GBT, 1HO, 1XM, 1CY, 1JAP, 2JU, 2BK, 2AR, 2QF, 2DA, 2RK, 2AJW, 2TK, 2RL, 2CT, 2PF, 3ADJ daylite, 3HF, 3CC, 3HG, 3BZ, 3XM, 3HX, 3ZA, 4FD, 3ABZ daylite, 3AF, 3RQ, 3ID, 3QE, 3CG, 3DK, 3XE, 3ZT, 3AKJ, 3ZA, 2EL readable all over room. I think 2EL is best station in second district. Along the Atlantic Coast he is about twenty times louder than any other station on the coast.

Heard by J. D. Hertz, Operator KMT, Libbyville, Alaska, lat. 59°N., long. 157°W.
 Between 12 and 1:30 a.m. May 23 in order of audibility: 6EX, 7BK, 6IM, 6AGF.

Canadian 3BP, Newmarket, Ont.

1AW, 1BM, 1CK, 1DAL, 1DH C.W., 1GM, 1IAT, 2IBZ, 1JAU, 1EBR, 1LZ, 1MAD, 1MAU, 1OE, 1QN C.W., 1TS C.W., 1UN C.W., 1ZE, 2ACT C.W., 2AGV, 2AGX, 2AHL C.W., 2AJW C.W., 2ARY, 2AWF, 2BB C.W., 2BFZ C.W., 2BK, 2EL, 2GL, 2GR, 2HU, 2KY C.W., 2MRY, 2NF, 2OM, 2RM, 2RU C.W., 2SZ, 2TJ C.W., 2UA, 2UK, 2WB, 2XA C.W., 2XF fone, 2XJ fone, 2XX fone, 2YM, 2ZL C.W., 2ZM, 3AAO C.W., 3ABE C.W., 3ANJ C.W., 3AQR, 3ARJ, 3HX C.W., 3BG, 3CC spk. & C.W., 3EH, 3EZ, 3FJ, 3HG, 3HJ, 3IW, 3MME C.W., 3NB, 3OU, 3PB, 3XAW C.W., 3XF, 3YG, 3ZO, 3ACF, 3AFB, 3AFD, 3AFO C.W. fone, 3AGK, 3AGO C.W., 3AGZ C.W., 3AHV, 3AIO C.W. & fone, 3AJ, 3AKW, 3ALY C.W., 3AMM, 3AMZ, 3ANT, 3AOT, 3APB, 3ARB, 3ARW C.W., 3AUY, 3AVT, 3AWK, 3AWP, 3AXC, 3AYM, 3AYN, 3BCI C.W., 3BEP, 3BKC, 3BO, 3BQ, 3CD, 3CP, 3DE C.W., 3DPI, 3DR spk. C.W., 3DV, 3DY, 3EV, 3FE C.W. & fone, 3FF C.W., 3GW, 3HJ spk. & C.W., 3HR, 3ID, 3JU C.W., 3LX C.W., 3MH, 3MM, 3NI, 3OE, 3OI, 3OW, 3PN, 3QC, 3SP, 3TT, 3TY, 3WY, 3XM C.W., 3YN, 3ZG C.W., 3ZR, 3AAW, 3ABL, 3AMK, 3AMS, 3ARK, 3FG, 3GC, 3GP, 3WW, 3UH, 3UU, 3ZJ, 3ZN, Canadian 3BA, 3DS, 3KS, 3LI.

T. G. Boright, Farnham, Que.

1AW, 1CK, 1FV, 1GM, 1OE, 1JQ, 1UL, 1ZE, 1CAY, 1DAL, 1MBS, 1OAG, 1TRJ, 2CC, 2AWF, 3PW, 8FW, 8ZP.

1DH, Winthrop, Mass.—All C.W.

1FQ, 1MO, 1OE, 1TS, 1BAY, 1VAK, 1NAQ, 1CBJ, 1IBJ, 1TBJ, 1ECK, 1FCY, 2DN, 2RU, 2XA, 2XT, 2ZL, 2ACT, 2ADL, 2AQM, 2BFZ, 2BML, 3BG, 3CC, 3EQ, 3FD, 3ZO, 3AAE, 3AAO, 3AKU, 3LF, 3LJ, 3RQ, 3VS, 3XE, 3XK, 3ADG, 3AIO, 3ARW.

1MD, Dorchester, Mass.

1AW, 1BAB, 1BBQ, 1CAO, 1CBJ C.W., 1CBT, 1CCX, 1CM, 1DAL, 1FQ C.W., 1GBC, 1HO, 1IAT, 1JAU, 1JQ, 1LBR, 1MAD, 1NBP, 1OE, 1QP, 1RAY, 1SBZ, 1TBW, 1TS, 1VAK, 1YB, 1ZE, 2AFP, 2AGK, 2AHU, 2AJW C.W., 2ARY, 2AWF, 2BEH, 2BG, 2BGR, 2BK, 2DI, 2DN, 2EL, 2JN, 2JU, 2ME, 2NF, 2OA, 2OM, 2RK, 2RM, 2SK, 2SZ, 2TS, 2UA, 2UD C.W., 2UK, 2WB, 2WD C.W., 2WM, 2XA C.W., 2XK C.W., 2ZL C.W., 2YM, 3ACE, 3ACS, 3AWV, 3BP, 3CC, 3CK, 3EH, 3EZ, 3FJ, 3GX, 3HJ, 3HX, 3IW, 3KM, 3NB, 3OU, 3PU, 3QN, 3TK, 3VW, 3WX, 3XF, 3XM, 3ZO, 4GL, 5DA, 5ZI, 5ACF, 5AGK, 5ANK C.W., 5AWP, 5ADQ, 5AIO C.W., 5APB, 5BCC, 5BO, 5DE C.W., 5FW, 5HR, 5IV C.W., 5NI, 5PL, 5RQ, 5SP, 5TY, 5WY, 5LQ, 5ME, 5ZJ, 5BQ.

1ES, Brookline, Mass.

C.W.—1AE, 1BAB, 1CBJ, 1HBP, 1MO, 1QN, 1RZ, 1TS, 2ABR, 2ACT, 2AHL, 2AJW, 2AQM, 2BML, 2BRC, 2IA, 3KL, 3RU, 2UD, 3WD, 3XK, 2ZL, 3AAE, 3AAO, 3ANJ, 3BZ, 3XF, 4GL, 8AIO, 8BCL, 8DE, 8OW, 8XM, 8Spark—1DAL, 1GBC, 1IBZ, 1JBF, 1LBR, 1RV, 1VAK, 1ZE, 2ACD, 2AGX, 2ARY, 2AWF, 2BG, 2BGN, 2BK, 2DI, 2DN, 2EL, 2JU, 2OM, 2RM, 2TS, 2UA, 2UK, 2WB, 2YM, 2ZR, 3CC, 3GX, 3HJ, 3HA, 3KM, 3WX, 3AWP, 3FW, 3PL, 3ZA.

1LT, Lowell, Mass.

1AA, 1ARI, 1AR, 1AW, 1BAY, 1BG, 1BGR, 1BP, 1CF, 1CJ, 1CM, 1CZ, 1DAL, 1DBI, 1DH, 1DR, 1DY, 1EP, 1FAM, 1GBC, 1GM, 1JBQ, 1KAA, 1LBR, 1LP, 1LZ, 1MAD, 1MAU, 1MBN, 1NBP, 1OA, 1OM, 1PAE, 1PBF, 1QR, 1RAY, 1SAF, 1SG, 1SN, 1TBY, 1UM, 1VAK, 1VAS, 1WBV, 1WS, 1XE, 1XM, 2AA, 2AB, 2AC, 2AGX, 2AJW, 2ARY, 2AWF, 2BGR, 2BSC, 2BK, 2BML, 2BQ, 2CC, 2DM, 2EL, 2HI, 2IJ, 2KL, 2KW, 2OA, 2OE, 2OM, 2QR, 2RM, 2RR, 2UA, 2UD, 2UK, 2WB, 2XA, 2XF, 2XJ, 2XK, 2XN, 2YM, 3AAO, 3ARX, 3ACS, 3AJW, 3ALC, 3BP (Canadian), 3CC, 3DP, 3FR, 3GX, 3HJ, 3HX, 3NB, 3NF, 3OB, 3OU, 3PU, 3RB, 3SX, 3SZ, 3WX, 3XF, 3ZO, 3AGK, 3AMQ, 3ANT, 3ARW, 3AWP, 3BDP, 3BM, 3BO (Canadian), 3BQ, 3DR, 3DV, 3DZ, 3EV, 3HR, 3LF, 3NI, 3OW, 3PL, 3RI, 3RY, 3TY, 3XE, 3XK, 3XM, 3ZR, 3ZW, 3ZJ, 3NSF.

1DY, Lynn, Mass.

1AW, 1BM, 1GM, 1CAY, 1CAO, 1DAL, 1HO, 1HAV, 1IAT, 1GBC, 1JBF, 1KT, 1LBR, 1MAD, 1NAQ C.W., 1NBP, 1OE, 1OT, 1SBZ, 1TS C.W., 1TBJ, 1VAK, 1YB, 1ZE, 2AAE C.W., 2(ACD), 2ACE, 2ACT C.W., 2AFP, 2AGC, 2AGO, 2AGX, 2AJM, 2AJW C.W., 2AHL C.W., 2ALK, 2ARY, 2AWF, 2AWL C.W., 2AYY, 2BEL, 2BGR, 2BFZ, 2BK, 2BM, 2BML C.W., 2BQ C.W., 2CY, 2DI, 2DN, 2DR, 2DX, 2EL, 2FG, 2GM, 2GR, 2IA C.W. & fone 2IM, 2JU, 2KL C.W. & fone 2KM, 2MB, 2ME, 2MJ, 2NF, 2A, 2OE, 2OM, 2OX, 2EQ, 2QR, 2RM, 2RR, 2RU, 2SQ, 2SZ, 2TH, 2TS, 2UA, 2UK, 2YW, 2ZW, 2WM, 2XA C.W., 2XK C.W., 2XM, 2ZD, 2ZM, 2ZR, 3ACE, 3BG, 3CC, 3EZ, 3GX, 3HG, 3HJ, 3HQ, 3HR, 3HX, 3IW, 3LP, 3OA, 3OU, 3PR, 3PU, 3TS, 3VW, 3WX, 3WB, 3WW, 3WX, 3XM, 4GL C.W., 4Y QSA, 5ACF, 5AGK, 5AOT, 5AP, 5APB, 5AY, 5AYN, 5AMQ, 5BO, 5(AWP), 5BQ, 5DE C.W., 5DP, 5DR C.W., 5DY, 5EV, 5FAT, 5GO, 5HR, 5FW, 5JG, 5MM, 5NI, 5PL, 5TY, 5WY, 5ZA, 5ZR, 5ZJ.

1CBT, Bridgeport, Conn.

1AW, 1CBJ C.W., 1GBC, 1NBA, 1OAL, 1QN C.W., 1RZ C.W., 1UN C.W., 1ZE, 2ACT C.W.,

2ADL C.W., 2AJR, 2AJW C.W., 2ALY, 2ARY, 2ASL C.W., 2AUB, 2AUL, 2AXB, 2AYT, 2BDU C.W., 2BFF, 2BFZ C.W., 2BGA C.W., 2BGR, 2BK, 2BML C.W., 2BQH fone, 2BRX C.W., 2BS, 2BSC C.W., 2BUT, 2CT C.W., 2CY, 2DI, 2EL, 2FR, 2HJ, 2IA, 2IF, 2AJU, 2KL, 2MO, 2NF, 2OM, 2OX, 2PW, 2QR, 2RU C.W., 2SZ, 2TC, 2TK, 2UC, 2UBA C.W., 2UK, 2VH, 2WD C.W., 2WM, 2XJ fone, 2YM, 2ZL C.W., 2ZM, 3AL, 3ACS, 3AWV, 3BP, 3CC, 3EH, 3GX, 3HJ, 3IAE C.W., 3IU, 3LP, 3NB, 3OU, 3PR, 3XG, 3XM, 3ZA, 3AW, 3AZ, 3BO, 3DY, 3GU C.W., 3HR, 3HJ C.W., 3OT C.W., 3PL, 3PU, 3WY, 3ACF, 3AGK, 3AGO C.W., 3AIO C.W., 3AMU C.W., 3AOT, 3APB.

2OM, Ridgewood, N. J.

1AW, 1CBJ C.W., 1CZ, 1DAL, 1DY, 1EP, 1M, 1GBC, 1GM, 1GY, 1HAA, 1HAF, 1JAP, 1MAD, 1MAU, 1NBA C.W., 1OB, 1OE, 1PAZ, 1PQ, 1RU, 1RV, 1SBZ, 1SN, 1XK C.W., 1XM C.W., 1ZE, 2AGK, 2SZ, 2BP (Canadian), 2AAE C.W. (3ABG), 2ACM, 3ACS, 3AHK, 3ALC, 3ALN, 3ANC, 3AS, 3AUC, 3BE, 3BG, 3CC, 3CK, 3CV, 3DT, 3EH, 3FM C.W., 3EN, 3EZ, 3FR, 3FV, 3GX, 3HG, 3HJ, 3HW, 3HX, 3ID, 3IW, 3JL, 3KM, 3LP, 3MD, 3NB, 3NF, 3OB C.W. (3OU), 3PB, 3PU, 3PW, 3QN, 3RY, 3SJ, 3VV, 3WV, 3WX, 3XF, 3XM, 3YO, 3ZA, 3ZO, 4GL C.W., 5DA, 5ACF, 5APA, 5AGK, 5AIO, 5(AWP), 5AKG, 5AMQ, 5ANW, 5AOT, 5AP, 5AWP, 5AXG, 5AYN, 5BFC, 5BG, 5BO, 5DE, 5DY, 5EV, 5FN, 5GX, 5HR, 5ID, 5KK, 5MT, 5NI, 5PL, 5PT, 5RQ, 5SP, 5TT, 5WY, 5XU, 5YN, 5AAV, 5AAW, 5ANY, 5CP, 5ME, 5UH.

2RR ex 2AFP, Paterson, N. J.

1ADL, 1AW, 1CK, 1CZ, 1DAL, 1DY, 1GBC, 1GBT, 1GM, 1HAF, 1HAU, 1LBR, 1MAD, 1MAU, 1OE, 1OT, 1SN, 1VAK, 1YB, 1ZE, 2(ABG), 2AN, 2ATJ, 2ATZ, 2BG, 2BP, 2CC, 2CK, 2EZ, 2GX, 2HG, 2HJ, 2HX, 2IW, 2JR, 2KM, 2KW, 2NB, 2OU, 2RX, 2UC, 2VW, 2XF, 2XM, 2AGK, 2ANT, 2APB, 2BO, 2DE, 2HG, 2HR, 2RQ, 2TT, 2AAW, 2ME, 2ZJ, C.W. Stations: 1FQ, 1QN, 1NAQ, 1TBJ, 1TS, 1CCZ, 2ABR fone, 2AGI fone, 2ACT, 2AHL, 2AJF, 2AJW, 2AKO fone, 2ANZ, 2AWE fone, 2AYZ, 2BBN, 2BEA, 2BED, 2BFZ, 2BG, 2BH, 2BHP fone, 2BML, 2DF, 2HZ, 2IA fone, 2JN fone, 2KL, 2MW, 2PE, 2RU, 2UD fone, 2VD fone, 2WB fone, 2XP, 2XJ fone, 2XK fone, 2XNB, 2ZE fone, 2ZL, 2ZM fone, 3HZ, 4GL, 4YB fone, 5AIO, 5WR.

2BFA, Troy, N. Y.

1AL, 1AW, 1ADL, 1BK, 1BU, 1BW, 1CK, 1CZ, 1CAY, 1DA, 1DY, 1DAL, 1GM, 1GBC, 1GBT, 1HO, 1HAA, 1HAF, 1HAL, 1HAR, 1HAV, 1HAX, 1HAY, 1MAD, 1MAU, 1MBN, 1OE, 1PB, 1PAZ, 1PBF, 1RAG, 1SN, 1SBZ, 1TBE, 1TBJ, 1XT, 1YB, 1YE, 1ZM, 2ABG, 2ACW, 2ADP, 2AFP, 2AJJ, 2AIX, 2ANM, 2ARY, 2AWF, 2BG, 2BK, 2BM, 2BQ, 2BQD, 2BKT, 2BSB, 2BTP, 2CG, 2DA, 2DR, 2DX, 2EL, 2FG, 2FM, 2GK, 2LD, 2MD, 2OM, 2PV, 2HW, 2ST, 2UA, 2XA, 2XAE, 2CC, 2DH, 2ES, 2PU, 2WX, 2AGM, 2AMQ, 2AMY, 2AOT, 2APB, 2BV, 2CL, 2CG, 2FW, 2ID, 2JS, 2KC, 2KP, 2PL, 2TB, 2TT, 2WY, 2XE, 2ZR, 2ZZ, 2DE, 2ZJ, 2NSF; C.W.: 1CDJ, 1DH, 1DR, 1MD, 1RQ, 1RZ, 1TS, 2ADL fone, 2AQM fone, 2AZP, 2BKB, 2EL, 2JU, 2LL, 2XQ fone, 2ZL, 2ZM, 2APH, 2NSF fone.

2MV, Keyport, N. J.

1AW, 1BBL, 1CK, 1DY, 1DAL, 1FW, 1GM, 1GBC, 1GBJ, 1GAL, 1JQ, 1ZE, 1JAP, 1MAD, 1MAU, 1OE, 1OAL, 1RAY, 2FG, 2SZ, 2BZ, 2CC, 2EN, 2EV, 2EZ, 2FR, 2GO, 2GX, 2HJ, 2HX, 2IW, 2KM, 2LL, 2NB, 2NX, 2OU, 2PU, 2RW, 2RY, 2WX, 2XF, 3AAO, 3ABC, 3ABG, 3AHK, 3AIG, 3AQR, 4AG, 4AL, 4BY, 1CK, 2CX, 4XC, 5DA, 5BC, 5DE, 5DP, 5DR, 5DV, 5FQ, 5HG, 5HR, 5KZ, 5ML, 5NI, 5NZ, 5SP, 5TT, 5WY, 5XE, 5XM, 5ABT, 5ADQ, 5AFB, 5AGK, 5AIO, 5AJT, 5AKA, 5AMQ, 5AMZ, 5AWP, 5AYN, 5BAC, 5FG, 5GP, 5LQ, 5MC, 5UH, 5UT, 5AAW, 5ZJ.

2KV, Bronxville, N. Y.

1AW, 1DAL, 1DY, 1FW, 1GBC, 1GM, 1JAP, 1JQ,

1MAD, 1MAU, 1RAD, 1TS, 1ZE, 2AXB, 2NF, 2SZ, 2ABM, 2ACE, 2ALC, 2ALX, 2AN, 2AQR, 2AS, 2ASW, 2BDP, 2BG, 2CC, 2DW, 2EH, 2EZ, 2GX, 2HB, 2HG, 2HJ, 2HX, 2IW, 2JH, 2KM, 2LP, 2MU, 2NB, 2OU, 2PU, 2RB, 2RX, 2UC, 2VW, 2WX, 2XF, 2XM, 2YH, 2ZO, 4CK, 4HT, 5DA, 5IW, 5ZX, 8AAU, 8AAZ, 8ADQ, 8AFA, 8AGK, 8AGO, 8AJN, 8AJT, 8AKA, 8AMF, 8AMQ, 8ANO, 8ANP, 8AOT, 8APB, 8AVP, 8AWP, 8AYN, 8BFV, 8BO, 8BQ, 8CZ, 8DJ, 8DR, 8EV, 8FN, 8HR, 8KO, 8KS, 8MM, 8MZ, 8NI, 8NN, 8PQ, 8RQ, 8SP, 8TT, 8TY, 8WY, 8WZ, 8XU, 8ZA, 8ZR, 9AAW, 9AFK, 9AHO, 9ANZ, 9EL, 9ME, 9UH, 9UU, Canadian 3BP, 3LI C.W.; 1CBJ, 1FQ, 1NBA, 1TB, 1XM, 2ACT, 2AFB, 2AJF, 2AJW, 2AKL, 2AKO, 2AMY, 2BDU, 2BEB, 2BFZ, 2BML, 2BOA, 2BPA, 2BQE, 2BSC, 2DM, 2DN, 2DW, 2GR, 2KL, 2LH, 2MW, 2RU, 2XF, 2XK, 2ZE, 2ZL, 3AAO, 3AJH, 3FD, 3JU, 3VU, 4GL, 4AIO, 4AKO, 4ANK, 4DE, 4DR, 4JM, 4JU, 4RQ, 4ZG.

2UK, New Brunswick, N. J.

1ADL, 1AW, 1BM, 1CZ, 1DAL, 1DY, 1GBC, (1GM), (1IAT), (1JAU), 1JAU, 1JQ, 1LBR, 1MAD, 1NAQ C.W., (1OE), 1RAY, 1SN, 1ZE, 2AGX, (2NF), 2SZ, 2UA, 2XK C.W., 3AN, 3AAO C.W., 3BZ C.W., (3CC), 3GX, 3HB, (3HG), (3HJ), (3IW), 3KM, 3LP, 3NB, (3OU), 3UC, 3YH, 3XF, 4FD, 4GL C.W., 8ADQ, 8AFA, 8AFD, 8AGK, 8AGO, 8AIO spk. and C.W., 8AIM, 8AJT, 8AKA, 8AMQ, 8ANT, 8AWP, 8AYN, (8BO), 8CK, 8DR, (8DY), 8EV, (8HR), 8MT, (8PL), 8QM, 8SP, 8TT, 8TY, (8WY), 8XM C.W., 8ZA, 8ZR, 9AAW, 8ANV, 9PC, (9UH), 9YAC, 9ZB, 9ZN Canadian 3BP, 3CI.

3AAY, York, Pa.

1AW, 1GM, 1JU, 1RZ, 1TS spk. & C.W. 1XD fone, 1XL C.W., 1ARY, 1GBC, 1HAA, 2BK, 2EL, 2JU, 2KL C.W., 2XJ fone, 2ZL C.W., 3BA, 3CC spk. & C.W., 3DH, 3DM, 3EL, 3EN C.W., 3HG, 3HJ, 3HX, 3IP, 3KM, 3LP, 3PU, 3RW, 3UC C.W., 3VV, 3WX, 3XM, 3ZO Spk. C.W. & fone, 3AAE, C.W., 3AAK, 3AAO C.W., 3ADB, 3AQR, 3AWR C.W., 3GL C.W., 4GN, 8BO, 8CH, 8DR, 8EV, 8HA, 8HR, 8ID, 8PT, 8TT, 8VW, 8WY, 8XM, 8ZA, 8ZG C.W., 8ZW C.W., 8ACP, 8AFM, 8AGD, 8AGK, 8AGO C.W., 8AIO C.W., 8APT, 8AKJ, 8AMZ, 9BY fone, 9HJ, 9LQ, 9UU, 9XM C.W., 9ZN, 9AAW.

3JR, Philadelphia, Pa.

1CK, 1CZ, 1DY, 1GM, 1JQ, 1MX, 1OE, 1OX, 1QE, 1SN, 1ZE, 1DAL, 1IAT, 1JAU, 1RAT, 1SAF, 2BG, 2BK, 2BM, 2CY, 2DN, 2EL, 2JU, 2ME, 2MJ, 2NF, 2OM, 2OX, 2QR, 2RM, 2TS, 2UA, 2UK, 2WB, 2WM, 2XK, 2AGX, 2AQL, (2ARY), Can. 3BP, 3EZ, 3GX, 3HG, 3IW, 3LP, 3MU, (3PU), 3RX, 3BO, 3EV, 3FT, 3FW, 3HR, 3ID, 3JU, 3KY, 3NI, 3PL, 3PN, 3TK, 3TT, 3TY, 3WY, 3ZR, 3AFA, 3AGK, 3AG, 3AHH, 3AIO, 3AMQ, 3ANO, 3AOT, 3AWP, 3AXC, (3AYN), 3ME, 3PC, 3UH, 3UU, 3WK, 3ZJ, 3ZN, 3AAW, 3ANV.

3ZO, Parkersburg, Pa.

1GB, 1RB, 1CK, 1DE, 1GM, 1AR, 1QR, 1JU, 1NU, 1ZE, 1AW, 1GX, 1CBT, 1DAL, 1LAR, 1MAD, 2SA, 2UA, 2WB, 2UD, 2OE, 2NF, 2BG, 2DI, 2HJ, 2BK, 2TK, 2UK, 2XK, 2EL, 2GL, 2GM, 2OW, 2RM, 2YM, 2ZM, 2DS, 2TS, 2JU, 2CC, 2SZ, 2ARY, 2AHU, 2AFR, 2ZA, 3HB, 3OB, 3CY, 3KD, 3BE, 3XF, 3GH, 3FI, 3HJ, 3XM, 3BN, 3MN, 3BP, 3LP, 3OU, 3PU, 3OV, 3PW, 3QW, 3GX, 3HX, 3UX, 3WX, 3XX, 3XV, 3ZZ, 3AIA, 3ABB, 3ADB, 3AAE, 3ACE, 3AVG, 3ADE, 3AAN, 3AAO, 3ABP, 3AOR, 3AQR, 3ACS, 3AT, 3AVY, NSF fone, 3DE, 3BF, 3PL, 3BO, 3AP, 3BQ, 3HR, 3TU, 3DV, 3AW, 3AX, 3DY, 3WY, 3AGK, 3AMM, 3AOT, 3AGX, 3CK, 3ME, 3UV, 3AAW.

3AJZ, Shamokin, Pa.

1AW, 1BBQ, 1CBJ C.W., 1DH C.W., 1FQ C.W., 1HBP C.W., 1OE C.W., 1OX, 1OZ, 1RAY, 1TS C.W., 1XM C.W., 2ACT C.W., 2AHL C.W., 2AQM C.W., 2ARY, 2AWL C.W., 2BK, 2BFZ C.W., 2DD, 2DR, 2EL, 2FG, 2GM, 2HA C.W., 2KL C.W., 2KY fone, 2MW C.W., 2OA, 2OM, 2RU C.W., 2SZ, 2UK, 2UD C.W., 2WB, 2WD C.W., 2XA, 2XK C.W., 2ZL C.W., 2ZM C.W., 2ZM, 3AAO C.W., 3AAE C.W., 3ACT C.W., 3ARY, 3BG, 3CC, 3DS C.W., 3EH, 3EN C.W., 3HB, 3HJ, 3NB, 3PB,

3PU, 3QW, 3RX, 3YH, 3ZA, 3ZO, 5DA, 5AFA, 5AFO C.W., 5AGK, 5AGO C.W., 5AGZ C.W., 8AIO C.W., 8AMM, 8ANK C.W., 8AXC, 8BO, 8DE C.W., 8DY, 8GO, 8HJ C.W., (8HR), 8KZ, (8PQ), 8OY C.W., 8RO C.W., 8SP, 8TT, 8TY, 8XK C.W., 8XU C.W., 8XM C.W., 8ZA, 8ZR, 8ZV, 9ALH, 9FS, 9MC, 9UH, 9ZJ, 9ZN.

3BAQ, Atlantic City, N. J.

1AW, 1BM, 1CK, 1CM, 1DY, 1HO, 1JQ, 1TS, 1C.W., 1ZE, 1DAL, 1GBC, 1IBZ, 1JAF, 2BG, 2BK, 2CL, 2CY, 2EL, 2FS C.W., 2JU, 2JW, 2KL mod C.W., 2NF, 2OA, 2OE, 2OM, 2PW, 2RM, 2TS, 2UA, 2UC, 2UK, 2WB, 2ZL mod C.W., 2ACD, 2AHK, 2AHO fone, 2AHU, 2AJW, 1C.W., 2ARY, 2AVR, 2AWS, 2BEH, 2BFX, 2BGR, 2BNU, 3AN, 3BA spk. & 1C.W., 3BG, 3CC, 3EH, 3EZ, 3FI, 3FR, 3GX, 3HG, 3HJ, 3HX, 3IW, 3LP, 3OU, 3PU, 3QN, 3SC, 3UC, 3WX, 3XZ, 3ZO, 3AAG, 3AAO C.W., 3ABG, 3ACE, 3ACR, 3ACS, 3AFK, 3AHS, 3ALC, 3ALX, 3AVG, 4BY, 5DA, 8BO, 8CL, 8DE C.W., 8DR, 8DY, 8HR, 8IL, 8KC, 8NZ, 8PL, 8TT, 8WY, 8XK mod C.W., 8XM C.W., 8AAQ, 8APB, 8AGK, 8AGO, 8AKA, 8AKJ, 8AOT, 8APB, 8AWP, 8BFV, 9ANV.

3AGL, Oley, Pa.—Silicon.

1DAL, 1GBC, 1MAU, 1AW, 1GM, 1PZ, 1ZE, 2RGH, 2BK, 2EL, 2JU, 2ME, 2NF, 2PL, 2RB, 2RM, 2SZ, 2UK, 2VW, 2WB, 2ZM, 2AB, 3CC, 3HJ, 3IW, 3JR, 3NB, 3PU, 3QW, 3XF, 3ZO, 4GR, 3AGK, 3AOT, 3APB, 3AWP, 3BO, 3CK, 3DR, 3PL, 3TT, 3WY, 9ZV.

John E. Cain, Nashville, Tenn.

2BB C.W., 2EL, 2ZL C.W., 3BZ, 4AG, 4CG, 4FD, 5DA, 5JD, 5YH, 8AIO C.W., 8BO, 8CL, 8DE C.W., 8DR C.W., 8EB, 8GY, 8ID, 8IV C.W., 8JM C.W., 8RQ C.W., 8TT, 8WY, 8ZR, 9AMS, 9ARK, 9FS, 9GX, 9LF, 9LQ, 9ME, 9OO, 9PC, 9SI, 9TW, 9UH, 9VZ, 9WT, 9ZN.

6FB, Redondo Beach, Calif.

6AE, 6AH, 6AK, 6AM, 6AR, 6BJ, 6DF, 6EF fone, 6FH, 6HC, 6HK fone, 6HP, 6IC, 6IM, 6IV, 6JE fone, 6JM, 6JN, 6JR, 6KA fone, 6KC, 6MK fone, 6MX, 6MZ, 6OH, 6PI fone, 6PJ, 6PR, 6TF, 6TV, 6VX, 6WG, 6WN, 6WZ, 6ZB, 6ZN, 6ZO, 6ZU, 6AAH, 6AAK, 6AAW, 6ADA, 6AEY, 6AFN, 6AFY, 6AGF, 6AID, 6AIF, 6AIW, 6ALU fone, 6ALV, 6APB, 6ASK, 6ASR, 6AUL C.W., 6XAD C.W., 6PGX? 7BK, 7ED, 7HF, 7IW, 7MF.

6ATS, San Francisco.

2BK, 5ZA, 6AK, 6EA, 6HR, 6IM, 6IG, 6JD, 6KA, 6LM, 6MX, 6OC, 6UV fone, 6VN, 6WG, 6XC, 6XG, 6XW, 6ZA, 6ZK, 6ZM, 6ZB, 6ZX, 7CC, 7CU, 7DA, 7FL, 7GB, 7ZV, 7ZB, 7ZR, 8ML, 9AM, 9ACD, 9ACH, 9GF, 9LC, 9XK, 9ZL, 9ZN, 9XI.

7ZJ, Vancouver, Wash.

DX in Dec., Jan. & Feb. on one step: 5FL, 5IF, 5XB, (5ZA), 5ZR, 5ZU, 5ML, 5ZR, 5ZY, 9AE, 9AGN, 9AIG, 9EE, 9EQ, 9HM, 9AN, 9LA, 9LR, 9OE, 9WU, 9XI, 9YL, 9YW, 9ZC, 9ZJ, 9ZL, 9ZN, 9ZQ.

7JS, Anacortes, Wash.

5AE, 6AAK, 6ABM, 6ABX, 6AFN, 6AID, 6AIW, 6AGN, 6APH, 6EA, 6DY, 6FC, 6HC, 6IC, 6IY C.W., 6KM, 6PR, 6TV, 6TW, 6WZ, 6XAD, 6XG fone, 6ZA, 6ZAA, 6ZN, 6ZO, 6ZR, 6ZX, 7AG, 7AD, 7AY, 7BD, 7BF spk. & C.W., 7BH, 7BK, 7BI, 7BO, 7BQ, 7BV, 7BA, 7BR, (7CC), 7CE, 7CL, 7CW, 7DA, 7ED, 7FL, 7FD, 7FQ, 7GA, 7GE, 7IN, 7Y, 7JE C.W., 7JW, 7KB, 7MN, 7KJ, 7KS, 7LR, (7LS), 7LW, 7LJ, 7MI, 7MF, 7MJ, 7NL, 7OF, 7OJ, 7QQ, (7V spk. & C.W.), 7XD, 7XF C.W., 7YA, 7YS, 7YJ, 7ZB, 7ZJ, 7ZP, Canadian, 5AD, 5BL, 5BR, 5CJ, 5CM, 5ED.

7ZO, Casper, Wyo., 5-3 to 6-30

5EW, 5HK, 5HL, 5HU, 5IF, 5JD, 5JR, 5ZA, 6DP, 6CV, 6DK, 6IF, 6IG, (6JT), 6KA, 6LC, 6MK, 6MB, 6NQ, 6OT, 6QR, 6SK, (6VS), 6AEL, 6AEZ, 6ADX C.W., 6AJX, (6ZA), (6ZH), (6ZZ), 6ZU, 6ZX, 6XAD C.W., 7BH, 7BQ, (7CC), 7CU, 7DH, (7EX), 7FL, 7FQ, 7HS, 7LU, 7LY, 7MB, 7MO, (7XD), (7ZG), (7ZM), 7ZH, 7ZT, 8KP, 8ZL, (9BW), 9CO, 9DE, 9JE, (9EE), 9EJ, 9EK, (9EL),

(9EW), 9EQ, 9FU, 9FT, 9FX, (9HI), 9HM, 9HN, 9IF, 9IY, (9JN), 9JA, 9JQ, 9KL, 9KO, 9KU, (9LW), 9LQ, 9LR, 9MC, 9NQ, 9NX, (9OE), (9OO), 9OA, 9PS, 9PI, (9QO), 9QH, (9TI), 9TV, 9UF, 9UT, 9UU, (9VW), 9VW, 9XL, (9XI), 9YA, 9YW, 9ZB, 9ZC, 9ZN, 9ZQ, 9ZY C.W., 9AAW, 9ABS, 9ACL, 9ACN, 9AEG, (9AEG), (9AFX), (9AID), (9AGN), 9AIF, (9ALG), 9ALU, 9ANV, 9ANP, 9AON, 9AOH, (9ARJ), 9ASF, (9ATO), 9AUG, 9AUG, 9AWX, 9AYW, 9AXU, 9DIW, 9DKD, 9DBT, 9DKB, 9DHA, 9DJX, 9XAE, 9ZAC.

SGP, Cheat Bridge, W. Va.

1FQ, 1GM, 1RO, 1TS, 1UN, 1XE, 1XF, 1GBC, 1JAU, 1MAA, 2BK, 2CC, 2DN, 2EL, 2KL, 2KM, 2KY, 2JU, 2OM, 2QR, 2RM, 2RU, 2SP, 2TS, 2TJ, 2UD, 2UK, 2ACT, 2ADL, 2AHL, 2ARU, 2ARY, 2AWL, 2BFG, 2BML, 2CA, 2XK, 2ZL, 2ZM, 3AD, 3AN, 3BJ, 3BP, 3BZ, 3CC, 3DS, 3EM, 3EN, 3EZ, 3HJ, 3HX, 3IW, 3KM, 3LP, 3MO, 3NB, 3PO, 3PU, 3UC, 3OU, 3WX, 3XF, 3XM, 3ZO, 3AAE, 3AAO, 3ACE, 3AN, 3ALX, 3AOL, 3AOT, 3AQR, 3BFZ, 3CK, 3FD, 3GL, 3GN, 3YH, 3AJ, 3BC, 3BK, 3BO, 3CL, 3DE, 3DN, 3DP, 3DR, 3DV, 3EB, 3EV, 3FN, 3FC, 3EB, 3HR, 3ID, 3IV, 3JU, 3LW, 3LX, 3MM, 3OA, 3OL, 3OP, 3OW, 3OZ, 3PL, 3PN, 3PT, 3PW, 3RQ, 3SP, 3TJ, 3TK, 3TT, 3TY, 3UL, 3UQ, 3WA, 3WM, 3WY, 3WZ, 3XM, 3ZA, 3ZN, 3ZT, 3ZR, 3ZC, 3ACF, 3AEE, 3AGK, 3AGO, 3AIB, 3AIG, 3AIO, 3AJT, 3AKW, 3AMZ, 3ANK, 3ANN, 3ANO, 3ANW, 3APB, 3APP, 3AQZ, 3ARS, 3ARW, 3ASA, 3AVT, 3AXC, 3AYN, 3AYT, 3BBU, 3BCI, 3BDP, 3BFW, 3GP, 3GX, 3KO, 3ME, 3NQ, 3OO, 3OE, 3PC, 3PD, 3UH, 3UW, 3XI, 3ZT, 3ZN, 3AAF, 3AAJ, 3AAW, 3AAY, 3ACP, 3AJA, 3ANC, 3AWP, 3AZX.

8DE, Akron, Ohio.

1TS I.C.W., 2BFZ I.C.W., 2BK, 2WB, 2XK C.W., 3AAO C.W., 3CC, 3HG, 3IW, 3AAV, 3AFA, 3AFB, 3AFO I.C.W., 3AGO C.W., 3AGT, 3AGZ C.W., 3AIO C.W., 3AJL, 3AKS I.C.W., 3ANO, 3AQD, 3ARD, 3AXR, 3BBW, 3BGD C.W., 3BK C.W., 3BO, 3DP, 3GW, 3HR, 3JM C.W., 3JU spk. & C.W., 3KE, 3MM, 3NI, 3NQ I.C.W., 3OI spk. & I.C.W., 3OS, 3PL, 3TJ, 3TS, 3TY, 3ZA, 3ZG C.W., 3ZR spk. & C.W., 3AAW, 3ACB, 3ACJ, 3ANV, 3AM, 3UU, 3ZN, Canadian 3BP

8TV, Jamestown, N. Y.

11AW), 1CK, 1DAL, 1GBC, 1GM, 1JAP, 1JQ, 1MAU, 1OE, (1SN), 1TBJ C.W., 1ZE, 2AHU, (2BK), 2EL, 2WB, 3AAO C.W., 3ADB, 3AHK, 3AIN, 3CC, 3DW, 3EZ, (3FJ), 3GX, 3HB, (3HG), (3HJ), 3HX, (3IW), 3KM, (3LP), 3NB, 3OU, (3PU), (3XF), (3AAZ), 3ACF, (3ACY), (3ADE), (3AEE), (3AFA), 3AGK, (3AGO C.W.), (3AIO C.W.), 3AIB, (3AJT), 3AKJ, 3AKV, (3AKW), (3ALU), 3AMB, 3AMM, (3AMQ), 3ANT, 3ANW, 3AOT, 3APB, 3ARS, 3ARW I.C.W., 3AUG, (3AVT), (3AWP), (3AXC), (3AYN), (3BBU), (3BBW, 3BDP, 3BK, (3BO), 3CH, 3CI, (3DE), (3DP), (3DR), (3DV), (3EB), 3ED, (3EV), 3FQ, 3FT, (3GO), (3GX), 3HA, (3HJ), 3HR, (3ID), 3LJ, 3IN, 3IV I.C.W., 3JU, 3KM C.W., (3LV), 3LX, (3MM), (3MR), 3MZ, 3NI, (3OA), (3OI), (3OZ), (3PL), (3PN C.W. & spk.), 3PT, (3QC), 3QM, (3TJ), 3TK, 3TT, (3VH), (3WA), (3WY), 3WZ, 3XM C.W., 3YN, (3ZA), 3ZN, 3ZR, 3AAU, 3AAW, 3ACJ, 3ACN, (3ANV), (3AWZ), 3CP, 3GX, (3KL), 3ME, 3NQ, (3UH), 3U, 3ZJ, Can. (3BP), 3DH, 3KS, 3KKA.

8HJ, Elmira, N. Y.—All C. W.

1DH, 1FQ, 1RZ, 1BAA, 1NAQ, 1JBT, 1TBJ, 2GK, 2HL, 2HZ mod., 2KL, 2MW, 2RU, 2TJ, 2UD, 2ACT, 2AGX, 2AHL, 2AIF, 2AJF, (2AJW), 2AQM, 2AWL, 2BFZ, 2BSC, 2XA, 2XK vs QSA, 3CC, 3AAO, 3XF (3AJ), 3DE, 3DR, (3FQ), (3JM), (3IT), 3OW, (3RQ), (3WR fone & mod.), 3AGO, (3AIO), 3ANK, 3ANV, 3ARW mod. vs QSA, 3AWI.

8TJ, Columbus, Ohio.

1AW, 1MAD, 2BK, 2EL, 2XK C.W., 2AHK, 2AHU, 2ARY, 3AN, 3H, 3EJ, 3IW C.W., 3LF, (3XF), 3XM C.W., 4AG, 4BY, 4GI, C.W., 5DA, 5YH, 5BA, 5BJ, 5BO, 5RP, (5DE C.W.), 5DP, 5DR C.W., 5DV, (5EB), 5EV, 5FI, 5T, 5GX, 5HR, (5ID), 5IN, (5IV C.W.), 5JM C.W., 5JL, 5LV, 5LW, 5ML, (5MM), 5MR, 5OA, 5OI, (5OZ), 5PN spk. & C.W., 5RQ spk.

& C.W., 5TK, (5TT), (5TY), 5WA, (5WY), (5WZ), 5XM C.W., 5YM, 5YN, 5ZA, (5ZR spk. & C.W.), 5ZY, 5ACF, 5ACN, 5ACY, 5AEE, 5AFD, 5AGK, 5AGO spk. & C.W., 5AIB, 5AIO C.W., 5AIZ, (5AJE), (5AJX), 5AKW, (5AMJ), (5ANO), (5ANY), 5APW, 5ARB, (5ARS), 5AUH, 5AVT, (5AYN), 5BRZ, 5BCY, (5BEN), (5BGF), (5BIT), 5CS, 5EL, 5FN, 5FS, 5GX, (5KL), 5KO, 5ME, 5NO, 5NQ, 5OE, 5PC, 5TE, 5UH, 5UU, 5UW, 5XI, 5ZJ, 5AAF, 5AAW, 5ACB, 5ACJ, 5AHZ, 5AMS, (5ANV), 5ASN, 5AWZ, 5DVE, Canadian 2DH.

8IV, Springfield, Ohio.

1TS C.W., 1CBJ C.W., 2BB C.W., 2BK, 2KY C.W., 2PW, 2UD C.W., 2ZL C.W., Canadian 2DH, 3AAE C.W., 3AAO C.W., 3BK, 3CC C.W., 3EN C.W., 3EZ, 3HB C.W., 3HJ, Canadian 3BP, 4GL I.C.W., 5AAE, (5AAZ), 5ACF, 5ACY, (5ADE), (5ADY), (5AEE), 5AFO C.W., 5AFD, 5AFS, 5AGK, 5AGO, (5AGZ C.W.), (5AIB), 5AIM, (5AIO), 5AJE), (5AJX), 5AKN I.C.W., 5ANK C.W., (5ANN C.W.), (5ANO), 5ANW, (5ANY), 5APP, 5ARD, 5AXC, 5AYN, (5AYB), 5BDO, (5BEN), 5BK, 5BO, 5CF I.C.W., 5DE I.C.W., 5EB, 5EZ, 5EC, 5GA, 5HR, 5IB I.C.W., 5ID, 5IL I.C.W., 5IN, 5LF I.C.W., 5MM, 5MR, 5NI, 5OI, 5PN, 5PT, (5RQ C.W.), (5TJ), (5TK), 5TT, 5TY, 5UZ fone, (5VS C.W.), 5WL, 5WR C.W., 5WY, 5XM C.W., 5ZA, 5ZG C.W., 5ZN C.W., (5ZR), (5ZU fone), 5ZV, 9AAV, 9AAW, 9ACB, 9ACE, 9AMT, 9ANV, 9API C.W., 9AWL, 9AWP, 9AZA, (9AZX C.W.), 9CP, 9FS, 9IF, 9IJ, 9LQ, 9MC, 9ME, 9OE, 9OC, 9PC, 9QH, 9SS C.W., 9UH, 9U, 9XI C.W., 9ZAE C.W., 9ZJ, 9ZN.

9KL, Spring Valley, Ill.

June 1-10, all districts, one tube: 1DAC, 1RAY 1TS C.W., 2ZL C.W., 2EL, 2BK, 2AJW C.W., 3AAO C.W., 3IW, 3HJ, 4XC, 4HG, 4YA, 5DA, 5KJ, (5ZL), 5ZA, 6VW I.C.W., 7IM, 7ZG, 8AAQ, (8AAZ), 8ACC, 8ACF, (8ACV), (8ACY), 8AEE, 8AFB, 8AGK, (8AIB), 8AIO C.W., 8AIX, 8AKW, 8ARW, (8AUS), 8AWZ, 8AYN, 8BK, 8BO, 8ON, (8CP), 8DE C.W., 8DP, (8EB), 8FT, 8GX, 8HR, 8IJ, 8IN, 8IV C.W., (8LU), (8MH), 8MM, 8NI, 8NZ, 8OI, 8OZ, (8TJ), 8TK, (8TT), (8TY), 8UW, 8WG, 8WY, 8XM C.W., 8YN, 8ZN, 8ZR, 8ZX C.W., 8ZZ, 8KKA fone, 9AAE, (9AAW), 9AAK, (9ABQ), 9ABU, 9ACB, (9ACJ), (9ACL), 9ACN, (9AFX), 9AGM, 9AGN, 9AHC, 9AHD, 9AHK, 9AHO, 9AIC, 9AIB, 9AKC), (9ALH), (9AMK), (9AMR), (9ANV), (9ARG), 9ARK, 9ARM, (9ASN), 9AVZ, (9AWX), 9AWZ, 9AXK, 9AXU, 9AZE, 9AZA, 9BI, 9CP, (9CS), (9DBU), 9DCI, 9DDG, 9DDV, 9DDW, (9DDY), 9DEI, 9DEU, (9DEV), 9DEW, 9DFE, 9DFO, 9DFX, 9DGD, (9DHD), 9DHZ, 9DJO, 9DKV, 9DLS, 9DMZ, (9DMP), 9DOZ, 9DPZ, 9DQY, 9EL, 9FS, 9FT, (9GC), 9GP, 9GX, (9HK), 9JG, 9JN, 9JT, 9KO, (9LF), 9LG fone, 9LQ, 9LW, 9MC, (9MIB), 9MM, (9MS), (9NJ), (9NQ), 9OO, 9OS, (9PC), 9GH, 9TI, (9TII), (9TW), 9UF, 9UH, (9UU), 9UW, 9VC, 9VL, (9VZ), 9WT, 9XG, (9XI), 9XM, 9YAC, 9ZC, 9ZJ, 9ZN.

9AAW, Chicago, Ill.

2EL, 2KL, (2OM), 2SK, 2TS, 2WB, 2AGX, (2ARY), (3BP Canadian), 3CC, 3EH, 2HP Canadian, (3IW), (3XF), 3JE, (3BO), (3CP), 3DR, (3EB), 3EV, 3FL, (3FT), 3GO, 3HR, 3ID, (3JU), 3LU, 3ME, 3MM, 3NZ, 3OH, 3OI, (3PL), 3PM, 3RI, 3SP, (3TK), (3TT), (3WA), (3WY), 3XE, 3YN, 3ZN, 3ZR, 3ZY, (3AAB), 3ACF, 3ACY, (3AEE), 3AFD, (3AGS), (3AGO), 3AHS, (3AIB), 3AIT, (3AKV), (3ARS), (3AWP), (3AYN), (3BBU), 3CS, 3DP, (3FG), (3FS), 3FX, 3GS, 3JT, 3KL, (3LF), 3LQ, (3ME), 3MS, 3OE, 3OS, (3PC), 3PL, (3UH), (3TW), (3VL), (3XI), (3ZJ), 9AFX, (9ANV), 9ARK, 9ARM, (9DAX), 9DKT, C.W.: 1TS, 2BM, 3AAO, 4GL, 5AH, 5CF, (5DE), 5JM, 5RQ, 5ZG, (5AGO), (5AIO), 9YI.

9CP, Hammond, Indiana.

2AGX, (2ARY), 2BK, 2OM, 3HJ, 3IW, 3KM, (3UC), 4FD, 4GL C.W., 5DA, 5YH, 5ZB, (5BO), 5CP, 5DE C.W., 5DR, 5EB, 5EV, (5FT), (5ID), 5LU, 5ML, 5NI, 5PL, 5PM, 5TJ, 5TK, 5TT, 5TY, 5WA, 5WY, 5XK, 5ZN, 8AAZ, 5ADE, 5AEE, 5AGO, (5AIA), (5AIB), 5AIO C.W., (5AKV), 5APP, 5ARS, 5AUS, 5AXC, (5AYN), 5CS, 5FSS, 9GX, 9HK, 9KL, (9KO), 9LF, 9LQ, 9LLW, (9ME), (9MS).

(9NQ), 9OE, 9OS, 9PC, 9TW, (9UH), 9UW, 9XI, 9ZJ, (9ACB), (9AFX), (9AN), 9AKC, 9AMS, (9ANV), 9AXU, (9DAX), 9YAC, (9DON),

9OX, Louisville, Ky., May.

(2BK), (2EL), (2OA), (2RK), (2SZ), (2TF), (2UC), (2ZD), (3AHK), (3ALN), (3GO), (3HJ), (3IW), (3QF), (3VV), (4AG), (4AL), (4BY), (4CD), (4CG), (4FD), (4XC), (4YA), (5BI), (5ER), (5XA), (5YH), (8AAG), (8AAZ), (8AEL), (8AGO), (8AJW), (8AL), (8AGK), (8AIO), (8AKH), (8ANK), (8BA), (8BC), (8BO), (8BV), (8CP), (8DC), (8GX), (8ID), (8IRS), (8JE), (8JL), (8JU), (8KK), (8KM), (8KZ), (8LF), (8LH), (8LU), (8LV), (8MH), (8MM), (8MP), (8MZ), (8NZ), (8OJ), (8QJ), (8RQ), (8RU), (8SP), (8TT), (8TY), (8VJ), (8WY), (8XE), (8XH), (8XS), (8ZL), (8ZY), (9AAC), (9AAV), (9AAW), (9ABL), (9ACB), (9AEE), (9AEG), (9AFX), (9AGY), (9AJI), (9AKC), (9AMP), (9AP), (9ASJ), (9ANV), (9AT), (9AWK), (9AWZ), (9BW), (9CA), (9CP), (9CS), (9DDW), (9DGP), (9ET), (9FN), (9GC), (9GN), (9GP), (9HM), (9HT), (9HY), (9JN), (9JT), (9KL), (9KR), (9LF), (9LX), (9MH), (9MS), (9NG), (9NQ), (9OE), (9PC), (9PS), (9PV), (9QJ), (9TW), (9UF), (9UH), (9UU), (9VR), (9WW), (9XR), (9XW), (9ZJ), (9ZU), (Canadian 3 BP), (XF-1), (NSF).

9DKR, Caledonia, Minn.

3AAO, 5HL, 5IF, 5IM, 5YH, GER, 7ZO, 8AAZ, 8AFB, 8AG, 8AIO, 8BO, 8CF, 8DE, 8DR, 8HR, 8JM, 8KL, 8LU, 8NZ, 8RG, 8TT, 8WA, 8WY, 8XK, 8XM C.W., *KN, 8ZR, 9AAW, 9AAV, 9ABY, 9ACC, 9ACF, 9AEH, 9AFX, 9AGN, 9AG, 9AHO, 9ANY, 9ANJ, 9APY, 9AS, 9ASN, 9ARS, 9ARZ, 9AYW, 9AY, 9AZA, *AZN, 9BM, 9CP, 9DKG, 9DLG, 9DRG, 9FS, 9GEH, 9LA, 9ME, 9OI, 9SQ, 9SS, 9TB, 9TI, 9UH, 9UU, 9XAC, 9XI, 9XG, 9XM, 9YA, 9YAC, 9YAK, 9ZC, 9ZI, 9ZN, 9ZS.

SPARK RECEPTION ON HONEYCOMBS

(Concluded from page 30)

If the Honey-Comb coils cannot be adjusted according to the above mentioned method I think it safe to say the set is not giving half as much as it is capable of and there is a "bug" somewhere which should be located and cleared. I do not know of any method which could be considered at all as generally good to locate this, as the trouble may be due to any number of different causes. However, if you have carefully examined the set for defects in wiring and have all wires as short and direct as possible and at the same time arranged as far from each other as possible and all connections carefully soldered it might be well to try another bulb which you know can be made to oscillate at 200 meters and if this does not clear the trouble the next step would probably be to try the set on another aerial, perhaps by taking it to a friend's house. The wires leading to the coil mountings are constantly being bent into different positions and sometimes break inside the insulation or the screws work loose and cause a case of trouble which is difficult to find because it will not stay in until located. This usually shows up on long as well as short waves. The coils sometimes do not make good contact in the jacks and cause trouble.

JUNE STATION REPORTS

1MD, Dorchester, Mass.

| | |
|---------------|---------------|
| Steadiest | Loudest |
| 1IAT-1SBZ-1ZE | 1MAD-1YB-1ZE |
| 2ET-3OM-2BK | 2AGX-2EL-2JU |
| 3CC-3HX-3OU | 3CC-3HJ-3NB |
| None | 4AL-4GL-4YA |
| 8AWP-SPL | 8AGK-8AWP-8SP |
| 9ZJ-9UH | 9UH-9ZJ-9LQ |

1DY, Lynn, Mass.

| | |
|-------------------|--------------|
| Steadiest | Loudest |
| 1ZE-1GBC-1MAD | 1ZE-1AW-1GBC |
| 2JU-2BK-2OM | 2JU-2BK-2OM |
| 3HJ-3HX-3OU | 3HJ-3PT-3HX |
| 8AWP-8ZR-8DR C.W. | 8AWP-8PL-8ZR |
| 9ZJ | 9ZJ |

3AGI, Oley, Pa.

| | |
|--------------|----------------|
| Steadiest | Loudest |
| 1GM-1DAL | 1ZE-1AW-1DAL |
| 2EL-2BK-2JU | 2EL-2JU-2BK |
| 3NB-3PT-3HJ | 3NB-3XF-3PU |
| 8AWP-8BO-8DR | 8AWP-8AOT-8APE |

SAGK, Lancaster, N. Y.—May

| | |
|---------------|--------------|
| Steadiest | Loudest |
| 1AW-1HAA-1MAD | 1AW-1GBT-1GM |
| 2EL-2JU-2SZ | 2EL-2JU-2SZ |
| 3CC-3NB-3HJ | 3CC-3NB-3HJ |
| 4AG-4XC-4CK | 4AG-4XC-4YA |
| 5DA-5YH | 5DA-5YH-5ER |
| 8SP-8ZL-8TT | 8SP-8TT-8XE |
| 9AAW-9ZN-9UH | 9UH-9ZJ-9AAW |

9HR, Middlebury Ind.

| | |
|-------------------|--------------|
| Steadiest | Loudest |
| None | 1RAY-1AW-1LB |
| 2EL-2ZL C.W.-2WB | 2EL-2WB-2WL |
| 3CC-3AAO C.W.-3HJ | 3CC-3EN-3GO |
| 5DA-3GA | 5DA |
| 8DE-8TK-8ZR | 8ZR-8DE-8TK |

2XX, OSSINING, N. Y.

(Concluded from page 46)

of the secondary and tickler coils. Constant duplex communication is maintained with 2BB where a similar loop is installed. 150 volts B battery is ample for this distance, which is about three quarters of a mile.

2XX's range is hardly known, but its signals have been reported consistently at Colorado Springs and a number of other points almost as far west and south.

RADIO FREQUENCY AMPLIFICATION

(Concluded from page 23)

patent situation seems to bar them from this country. Are we American amateurs to be outstripped by tubes brought across the pond? Such tubes ought to be a cinch to manufacture, as we positively don't want them based and they don't have to be standardized to any other part of our equipment. We can promise a big market for a really good amateur-frequency amplifying tube and the apparatus that goes with it.

Do we hear any response?

Radio Communications by the Amateurs

The Publishers of QST assume no responsibility for statements made herein by correspondents.



HOW TO GET WHAT WE NEED.

2637 Garfield St., N. W.,
Washington, D. C.

Editor, QST—

It has seemed for some time past that manufacturers of radio apparatus, with a few conspicuous exceptions, have no clear conception of what apparatus is wanted in our A. R. R. L. stations. We have been offered sending transformers whose voltage was too low, rotary gaps of flimsy construction, wave meters that barely reach the proper limit of our assigned wave length range, and we were for a time hard put to it to obtain the gas type of detector tubes, which experience had taught us were far superior to the hard tubes the manufacturers insisted on attempting to introduce. It seems also that this condition could be much improved if there were a method whereby we could indicate to the manufacturer what apparatus we do want. The natural medium of expression of amateur opinion on any subject has come to be the QST. Can we not in its columns discuss the individual pieces of apparatus making up the citizen radio station in a series of symposia written by those among us qualified to express opinion? I am quite satisfied that there are among us those who can make suggestions which will be well worth the manufacturers' consideration.

Specific subjects for such discussion are:

1. A sending transformer with a fairly respectable power factor, a sufficient voltage so that a full kilowatt may be put into a 0.008 microfarad condenser at 240 sparks per second and with enough ruggedness so that the strain of operating on a synchronous rotary gap will not destroy the secondary.
2. A detector tube with a base and socket that do not have excessive capacity between the leads.
3. A radio amplifier tube meeting the same requirements.
4. A spark gap that is at the same time well muffled, well cooled and sufficiently insulated to withstand peak voltages of 45,000 to 50,000.
5. A wavemeter that is really beyond criticism and that does not start at 180 meters and go to 600, but starts at 125 and goes to 250.

This list does not contain all the apparatus needing improvement, and for that

matter does not necessarily list the apparatus most in need of improvement. It seems to me that a really good list of this type would serve as a basis for an excellent series of QST articles written by A. R. R. L. members and that those articles would bring response from manufacturers as promptly as did our request for an audiotron adapter and for power tubes.

S. Kruse.

(Correspondence from amateurs and manufacturers is invited on this topic.—
Editor.)

A SUGGESTION TO MANUFACTURERS AND DEALERS

Y.M.C.A. Radio Club, 2SZ,
Troy, N. Y.

Editor, QST—

Just a few lines regarding DX work which should interest all those handling messages. I have noticed that few relay messages carry any date or by whom they have been forwarded. I think that both of these should be on every message when possible for it will show how long the message was on its way and what stations were responsible for its delivery.

One more thing. Manufacturers are coming to realize the importance of standardization in parts and completed units. FB! Now, why don't they standardize the form and size of their catalogs? There are as many different sizes of radio catalogs published as there are breakfast foods and then some. It almost requires the services of a "radio stenographer" to find a particular catalog if one has much of a pile of the current radio literature. The manufacturers would do well to consider the merits of a standard size loose-leaf system, i.e., the 8½ x 11½ sheet. It can be easily kept in a letter file or a loose-leaf note-book. In the end this size should prove cheaper in cost since the size paper would be standard with most firms.

More descriptive matter and larger cuts could be published on one sheet, and new sheets issued occasionally, thereby doing away with the expensive catalog. New price sheets could be issued monthly, keeping patrons informed of changes in prices and eliminating the waste of time in answering letters of this nature. A loose-leaf catalog of such size would appear very business-like and give its owner something to be proud of. Come on, you radio men,

let's have a trunkful of suggestions on this matter and express yourselves.

Sincerely yours,
E. M. Williams.

GROUND LEADS AGAIN.

Marion, Mass.

Editor, QST—

Referring to Mr. Hanes' letter, "The Old Unanswered Question," on page 55 of June QST, I wish to try to give a reasonable account of what I consider the solution to this problem.

The piece of pipe 20 ft. long referred to by Mr. Hanes could be used the same as a wire. If this pipe were run out of the ground, and perfectly insulated from all connection to anything else, it would constitute a lead 20 ft. long, and should under such conditions be counted as such.

But if we take this same piece of pipe and lay it (horizontally) on the ground, and then connect the ground lead to one end of it and to the other end a second pipe running into the earth (or any other earth connection) the effect is entirely different. The 20 ft. pipe no longer adds 20 ft. to your antenna circuit. This oscillating circuit ends at that point where the ground wire or connection comes into contact with anything that offers the least fraction of an ampere escape to earth. In this second case the fact that the pipe is lying on the ground affords ample escape for the currents to ground, and rather than run the length of pipe as in the former case where the pipe was perfectly insulated the ground current begins to escape at the first point of contact or leak it finds. High frequency currents are very easily led along the path of least resistance, and like lightning they take the shortest route regardless of the conductor you have supplied for them. Some of the current of course runs along the remainder of the pipe but there is sufficient running off at the leaks to make a wave length of 200 meters show up on the wave meter. The H. W. A. in this circuit, however, would show a very poor reading, and this is just why these long-ground-lead men do not do the DX work. This is also why the insulated counterpoise has the advantage over the ground; there is no chance for a leak and the ground connection can be tuned to a hare's breath, with the result that the current comes on with a slap at the same time, giving a much higher reading. This is also the theory of the Round ground.

As to the matter of the fellow on the sixth floor being able to get a reading of 200 meters on his waterpipe ground, the same thing prevails. Water pipes in buildings are not set up on electrose insulators, and everything they touch—cement floors, wet or dry wood, kitchen sinks, metal lath

work, etc.—offers leaks to a very punk ground, so that rarely any of the oscillating current reaches old mother earth via the pipe. The ground connection begins at these leaks, all of which are of different capacities, lengths, etc., and it is possible to tune thru the leak to 200 meters, but these stations do not do real DX work. The only thing in their favor is the fact that their aerials are high, and any good work they ever do should be credited to this rather than to such a rotten ground system as a water pipe offers.

Very truly yours,
Irving Vermilya, 1ZE.

SOME KINKS.

997 Sterling Pl.
Brooklyn, N. Y.

Editor, QST—

The appended diagram shows what I think is a pretty neat way of mounting a switch on a tapped honeycomb coil. A piece of wood is cut to fit inside the coil; holes are drilled for the contacts and switch lever, and connected as per diagram. This makes a neat and efficient way of connecting the Radio 1200-3, covering practically all commercial wave lengths.

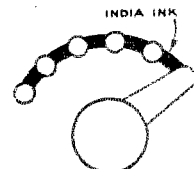
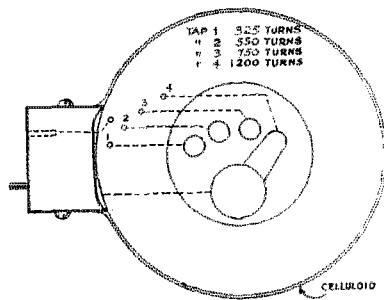

VARIABLE GRID LEAK

I have found a variable grid leak necessary in changing from short to long waves, so I mounted a few contacts on the front of my panel and between and touching the contacts I put india ink, as per diagram.

Yours truly,
H. B. Pearson, 2AFV.

SPARK SETS FOR SALE.

U. S. Shipping Board,
45 Broadway, New York.

Editor, QST—

The Shipping Board has no appropriations for advertising its used radio equipment. I think you will be able to help us sell it and help some good citizen radioists to acquire valuable apparatus at low costs. We have in our warehouse at New York:

Two ½ k. w. 240-cycle Canadian Marconi sets.

One ½ k. w. Canadian Marconi set.

Two ½ k. w. Cutting & Washington sets

Two ½ k. w. Simon sets

They are not in the best of condition but are all in fair shape. Let the glad news get about that these will be sold for less than 10% of their cost price. Further information will be available soon.

Sincerely,
Herbert Kayser,
Asst. Radio Supervisor.

RATING TRANSMITTERS AND RECEIVERS

Fort Riley, Kan.

Editor, QST—

There was a time in the radio game when inductance and capacity were expressed in descriptive terms, the proper values were arrived at by experiment, and the only way to convey the idea to others and reduce it to print was to describe the inductance in numbers of turns, spacing, size of wire, and size of form on which it was wound. This method is still of value because measuring instruments are expensive, and the calculations of one experimenter serves many, but to immediately express the idea in an article we use the standard henry and farad.

When we read in "Calls Heard" that 1GOOD is heard by 9FAR we require further information before we can determine whether the credit should be given to the transmitting operator, his transmitter, the receiving operator or his apparatus. In many cases all four are to be congratulated and the human element cannot be expressed in figures, but why not at least attempt to rate the efficiency of the apparatus by checking the defects of a given transmitter or receiver against an arbitrary standard the details of which should be decided by a group of experienced men who have worked with a 200 meter wave long enough to know what it means? In the April number of our QST we read what is thought of the Ideal Spark Transmitter, and we also learn that the Editor has an idea about grounds which he cannot suppress, in which I am sure we all concur with him. The reader should be given some information relative the equip-

ment of the receiving station in the "Calls Heard" column.

If it is feasible to establish the details of an ideal transmitter, we will get answers to our inquiries re a man's power which will read something like this "Have a 1 KW set which is rated at 84 by the A.R.R.L. 1921 standard", instead of a long detailed description of aerial, ground, O.T. primary circuit, condensers and what not, and nine times out of ten omitting an important item.

The receiver in the same way can be rated on a basis of 100 representing our present ideas of a 200 m. receiver. A set rated at 100 today will perhaps rate 75 or 80 in 1922 and may be obsolete in another five years if some genius will tell us how to simplify to two controls without loss of efficiency. The experimenter should send details to QST and receive their ratings. It will stimulate him and he will measure the inductance and capacity of his antenna, something which many of us have not done. His calls heard will be titled "9MAV Chicago, Ill. Receiver rating 93 A.R.R.L. 1921 standard, plus 2 steps A.F.Amp." and the stations heard will know whether this reception is extraordinary or not. If a transmitter is heard over a great distance with an 85% efficient receiver with but one tube, it will stimulate thought along the lines of carrier waves, the influence of "electrical storms", magnetic refraction, and may yield some valuable QSS information.

To read the calls heard column is depressing to some of the experimenters using indoor aerials and this type of antenna is becoming more common every day. In this column he reads of receptions over distances which he cannot approach and naturally he wonders what sort of a receiver was used. His curiosity should be gratified without the necessity of writing letters. Many of the old birds who were in the radio game in their high school days have had relapses and are as badly infected with Radiopsychosis as ever but balk at the outdoor aerial and its by-product of publicity. His business associates cannot understand why he derives more enjoyment from listening in than reading Keats.

I suggest that QST publish a standard 100% rating for transmitters and receivers, dividing it into three sections: aerial, the transmitter or receiver itself, and the ground.

The board should decide how many counts should be given to each of these three big elements dividing the 100% as they may consider appropriate: for instance, the ground in a receiver is not of as much importance as that of a transmitter. In a receiver the proportion might be Aerial 30%, Apparatus 60% Ground 10%. Then

the type of aerial counting 30 (the ideal) should be described together with other types and dimensions less efficient than the ideal, with their ratings. I do not know what the board will decide upon as the best aerial but if they decide upon an aerial of a natural period of 20 or 30% of the wave length to be received, inverted L, with an inductance of x , a capacity of y , and z feet high, we can all figure our efficiency.

This may seem a wild dream to some, but it may start constructive thought in the minds of others, and is submitted with the hope that the "Calls Heard" column will yield more information to the interested reader, in the future.

"T TYPE".

ERRATUM.

Marion, Mass.

Dear Eddy—

On page 44 of your June issue under the heading of "Strays" you have an article taken from the "New York American."

I wish to take issue with you on the following small but important point. The article as quoted from the "American" says: "The transmitter was connected to the antenna." You have had the nerve to go so far in your sketch of the new idea as to supply the "New York American" with a ground connection when none whatsoever was mentioned as being used. I am sure that none was used, as it seems quite reasonable to believe that if such had been the case, it would certainly have been mentioned. I am surprised at your ignorance, supposed, as you are, to be an editor.

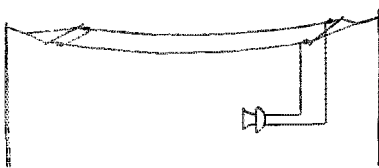

Now my idea of the thing, if I may be permitted to vouch an opinion, is that a loop antenna was used and no ground employed, the connections being merely as reported: the "transmitter hooked to the antenna."

The diagram is herewith.

Yours truly,

Ohmy.

DROP 9EL A LINE.

Council Grove, Kan.

Editor, QST—

Possibly some of the fellows have wondered why they have not heard 9EL. I have been flat on my back for the past six weeks and am still there. Doctor says I will get out in a few weeks he thinks.

I have received my second QST in bed and I want to tell the fellows the way to really enjoy QST is to get it while you're laid up. I started on CW before I got sick and when I get my strength back I am going to finish it. As to my troubles, I went fishing, got my feet wet, and it developed into about everything. Soon I am going west and visit some of my western radio friends. Expect to stay at Phoenix, Ariz., for some time, and possibly may see 6IG whom I have worked many times.

With kindest personal regards,

H. L. Owens.

RESOLUTION.

The Atlanta Radio Club.

Atlanta, Ga., April 30, 1921.

Whereas: there has been established in the city of Atlanta a radio school known as the National Radio Institute, which is owned, operated, or directed, by one R. E. Autrey; and

Whereas: it has been thought by some persons that this school was connected with, endorsed by, or under the auspices of the Atlanta Radio Club; and

Whereas: it has been believed that the above mentioned school would have some direction or control of amateur radio interests in the city, or that the said school would have certain rights in regard to control of radio traffic in this city; and

Whereas: it is reported that up to a recent date this school has operated a station for transmitting radiograms, or has transmitted signals by radio without being properly licensed by the government, in direct defiance or disregard of the laws of the United States, and furthermore has used a fictitious station call signal, which is in further disregard of the laws of the United States; and

Whereas: the above mentioned R. E. Autrey has appropriated to himself the title of "Radio Superintendent" and has insinuated that this title is used by virtue of authority vested in him by the government, although there is no officer of that title in the employ of the government of the United States; and

Whereas: we, the members of the Atlanta Radio Club, do not believe from our knowledge of conditions existing in the field of commercial radio-telegraphy that the claims made by this radio school as to their ability to equip operators for commercial positions in the time stated are practicable, nor do we believe in the feasibility of establishing radio stations for commercial traffic in accordance with plans proposed by the director or directors of this radio school, it being reported that they have attempted to sell stock for this purpose.

Therefore, be it resolved that we, the members of the Atlanta Radio Club, do

publicly declare that we have no connection with the National Radio Institute's Radio School, and that we are not in sympathy with any of its plans, operations, or proposals, as at present constituted; and

Be it also resolved that a copy of this resolution be mailed to the National Radio Institute, that copies be mailed to the local press and the QST magazine, and also a copy to the Secretary of State.

(Signed)
The Atlanta Radio Club.

ANTENNA CURRENT METERS

Schenectady, N. Y.

Editor, QST—

As an interested reader of your magazine, I have noticed an increasing tendency among your contributors during the past season to speak of the hot-wire ammeter somewhat disparagingly, and to cite thermo-couple readings as law and gospel. Now it has been my experience that the former is not altogether bad, nor the latter altogether good. In fact, the effective value of antenna current means very little anyway unless one knows at the same time such connecting factors as spark-frequency and radiation resistance of antenna as related to total resistance. Such factors remaining constant, the reading of antenna current furnishes a very good criterion of performance for a given station at different times; but for a comparison of two different stations, current readings mean little.

As to the instrument itself, it is entirely possible that the average correctness of all thermo-couple ammeters now on the market is of a higher order than the average for all hot-wire instruments, due rather to precision of manufacture and calibration than to any inherent characteristics of the type of meter. The probable truth of the matter is that popular demand has called for a less and still less expensive instrument for radio-frequency currents; and this demand has been met by the simpler type, in which accuracy has been somewhat sacrificed for cheapness. Low cost requires a minimum of material, and consequently minimum size so far as may be consistent with rough-and-ready factory methods of manufacture. But the smaller instrument is inherently incapable of the accuracy obtainable in the large sizes, so that the purchaser of a very cheap hot-wire meter is doubly unfortunate. It is questionable if he would be any more fortunate with a thermo-couple meter built as cheaply.

One of the most important points to be considered in the use of an ammeter is the resistance of the meter itself, for a high-resistance meter in a low resistance circuit gives an erroneous impression, even though the instrument itself be entirely accurate. The accompanying curves

show a comparison of DC resistance between terminals of hot-wire and thermo-couple ammeters. Both types referred to are built by the same company. A brief analysis shows that for a range of scales from 2 amperes up, the hot-wire meter has about double the internal resistance of the thermo-couple instrument, the ratio decreasing in the larger scales. However, an addition of 1/10 or 2/10 ohm to the 10 or 20 ohms of the average antenna is scarcely prohibitive. But for scales of 1 ampere or less, the thermo-couple becomes much more attractive, and for very small radio-frequency currents is invaluable.

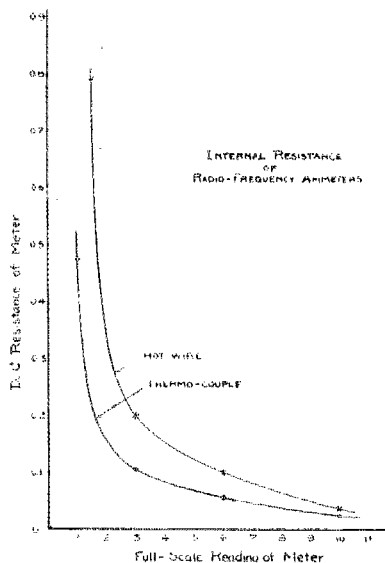

One more essential point should be mentioned here in connection with the use of such meters, and that is the unfortunate habit they have of burning out. The thermo-couple meter has a lower thermal capacity than the commercial hot-wire meter, and a smaller margin of safety in the way of overload capacity. That is to say, it will be burned out in time by a smaller percentage of overload continuously applied, or almost instantly by an excess of current which the hot-wire meter might carry for a second or two. Hence those who change from the one type of meter to the other will find that they need to be more cautious about exceeding the full-scale reading.

In conclusion, I would like to express the hope that your readers will not be too hasty in condemning the fellow who is so old-fashioned as to stick to the hot-wire instrument. With best wishes for the continued success of Citizen Radio, I am

Sincerely yours,
G. G. Meyers.

COMMENT ON MR. MEYERS' LETTER

Jewell Elec. Instrument Co.,
Chicago, Ill.

Editor, QST—

The communication of Mr. G. G. Meyers, with reference to high frequency ammeters, has been brought to my attention, and I hasten to say a few words on the subject.

With regard to the first paragraph, the writer is in entire accord with the statement that the antenna current alone does not tell the whole story and must be considered in connection with a number of other important factors. These factors, however, are well known and are not in the nature of argument.

As to the second paragraph, there is absolutely no question but what the average correctness of thermo-couple ammeters is of a decidedly higher order than that of hot wire instruments, and while due somewhat to better manufacture, the writer believes that their real superiority lies in their inherently superior characteristics. Temperature compensation is inherent in the thermo-couple instrument, while in the hot wire instrument such corrections must be made by hand, and a well known electrical engineer once expressed the opinion to the writer that a hot wire ammeter made a much better thermo-meter than an electrical measuring instrument.

As regards the resistance of the instrument, it seems obvious that the lower the instrument's resistance the less energy losses we have, and the Navy specifications definitely put a limit on energy loss allowable. Mr. Meyers' curves indicate a much lower resistance for the thermo-couple instrument, which is, of course, very much in its favor.

With reference to the habit of high frequency ammeters burning out on overload, this applies to any thermal instrument, and is due to the fact that the heat increases as the square of the current. They simply cannot be made to stand the overload which commercial frequency instruments of other types will stand.

However, practically all reliable makes of thermo-couple instruments on the market are guaranteed to stand from 30% to 50% overload, which should be ample if properly used. No one should expect an instrument to stand up under abuse, and if short circuited, one can hardly expect the instrument to remain in good condition. The writer doubts very much if there is a great deal of difference in the overload capacity of the hot wire meter as opposed to the thermo-couple type, since they both work on the same principle, that is, of measuring through the medium of heat.

Mr. Meyers said very little of the importance of accuracy in this connection, and the writer would like to point out that

if proper results are to be obtained in a station and improvements made to increase the antenna current, it is absolutely necessary to have an ammeter which reads the same yesterday, today and next week. This the thermo-couple instruments will do. Again, if the antenna ammeter does happen to burn out or is otherwise out of commission, and a new one is obtained, to compare results with those previously obtained one must be assured that the instruments are accurate.

In concluding, the writer has never seen a thermo-couple instrument in error more than 3% and this includes reports of a number of men prominent in our game. On the other hand, hot wire instruments are frequently in error from 25% to 50%, and the writer can cite specific cases to this effect. Where this large difference in error presents itself, can there be any basis for a logical comparison of the two types of instruments?

Yours truly,
John H. Miller.

TELMACO

TELMACO means quality goods at the right prices together with prompt and courteous service. It always insures satisfaction.

Our three stores, now open, are the result of our efforts to render Radio Amateurs a real service. We believe we have done it. Ask the Chicago Amateurs. We can serve you—by mail—equally well.

Our new catalogue "T" will be sent gratis. Write for your copy today.

SPECIAL SALE
While They Last

Attractive Proposition to the trade
MAGNAVOX
DISTRIBUTORS

Telmaco Blue Label
Honey Comb Inductances

Maximum Discounts Allowed
Dealers
Prompt Deliveries

| No. Turns | Approx. W.L.R. | Price |
|-----------|----------------|--------|
| 25 | 130-250 | \$0.40 |
| 50 | 250-700 | .50 |
| 100 | 500-1200 | .60 |
| 325 | 1600-5000 | .80 |
| 500 | 3500-8000 | 1.00 |

Other sizes in proportion. Order today.
Radio Supplies Division.

Telephone Maintenance Co.

17 N. LaSalle St., Chicago, Ill.
Meet us at the National A.R.R.L. Show,
Booth 24.

\$5.00

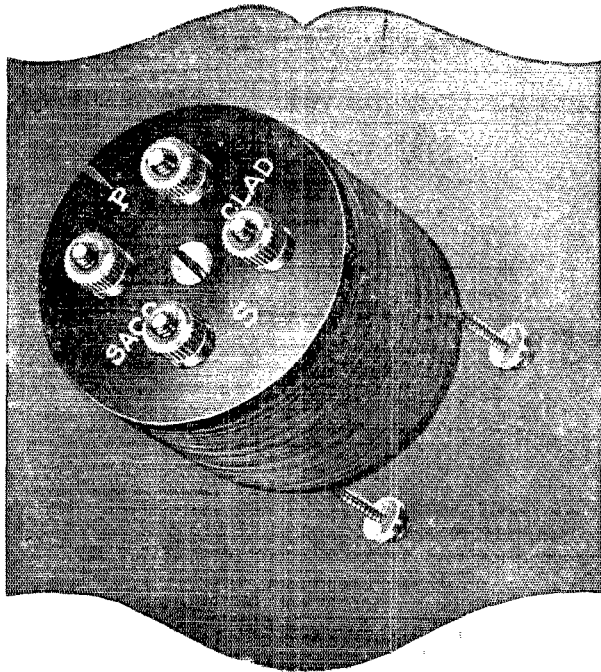

\$5.00

Photograph shows an ABC SACO-CLAD amplifying transformer, $\frac{3}{8}$ actual size.

Use **ABC SACO-CLAD TRANSFORMER** *No magnetic leakage-no howling*

A SOLID WALL OF METAL, $\frac{7}{16}$ OF AN INCH thick, completely encloses the SACO-CLAD. Magnetic leakage is impossible!

The primary and secondary coils are wound around a core of laminated silicon steel. Every part is securely fitted *under pressure*, and the whole held together in one solid unit. Ordinary rough usage that would ruin most transformers has no effect on the SACO-CLAD.

SACO-CLAD'S step-up ratio is 4 to 1,—instead of the usual 3 to 1 or less. Use SACO-CLADS to get a higher voltage in your grids.

SACO-CLAD transformers are designed to provided the correct ratio of impedance for present-day VTs. Six steps of SACO-CLAD amplification have been used *without any howling whatever*. And with 600 SACO-CLADS already in use, there has never been a single burnout.

ABC SACO-CLAD transformers are built entirely in the ABC factory, including the windings. ABC engineers had to design a special winding machine to use #40 enameled wire, in place of the usual #44. And, while there never has been a single burnout, the Wireless Equipment Co., Inc. accepts full responsibility for all ABC

SACO-CLAD transformers. Build your amplifiers with ABC SACO-CLADS,—satisfaction is assured by the ABC guarantee. "Your Money's Worth or Your Money Back!"

ASK your radio dealer for ABC SACO-CLADS. If he should happen to be without them, send his name and address, and 10 cents for the new ABC 2-color catalogue, CQ8, "Professional Radio Equipment at Amateur Prices". If there is no dealer in your vicinity, send your order by mail.

WIRELESS EQUIPMENT CO., INC.
32 Austin Street, Newark, New Jersey

ABC SACO-CLAD *Standardized Radio* **ABC TRANSFORMER**

Just mail this coupon and one dime today to the Wireless Equipment Co., Inc., Newark, N. J. for the ABC catalog, CQ8.

Name

Address

City State



E. H. FELIX

WHAT IS C-W C?

The Newest and Latest Thing in C-W

By

Edgar H. Felix and William F. Diehl

The engineers and the big fellows know how to handle C-W. Others have been teasingly told of their fascinating feats.

C-W C is the *first* complete and simple presentation of C-W instruction, construction, adjustment and operation.

With C-W C you can now do what the big fellows are doing.

You can perform their feats on low power, summer and winter, and at one-quarter the cost of your spark transmitter.

What is the best way to get plate potential for a one receiving tube transmitter, if your power is 110 A. C.?

Shall I use a chemical rectifier? Spark coil as transformer? Special transformer? Dynamo? Dry battery booster? Home-made storage battery?

C-W C tells how to get maximum range with your apparatus.

Who They Are and Why I Captured Them

I refused to issue a C-W C, until convinced that it could be made of real service,—so that every amateur could use it.

For many months, I kept my eyes open for men having (1) the knowledge of engineers, (2) the experience of amateurs, and (3) the ability to write simply and clearly on the subject.

I learned of 71 men who might meet these three requirements. Of these 71 men, I chose two: Felix and Diehl as the best.

E. H. Felix, I.R.E., A.I.E.E., Engineer, Radio Development Section, Signal Corps, Washington, in charge of the continental radio reports from Allied Governments during the war; has operated shore and ship commercial sets, aircraft spark, C-W and telephone sets, and all types of amateur sets; also a writer, an editor and advertising man—former Associate Editor of *Aerial Age Weekly*, special writer for *New York Tribune*, publicity work in National Political Campaigns, Publication Manager for Aircraft Expositions—which means that he

knows how to get things over in the clearest, briefest way.

W. F. Diehl, I.R.E., R.C.A., Chief Engineer, Grebe Radio Company; much of the apparatus you are using has been developed and designed by him; formerly Chief Electrician, Bureau of Inspection, Third Naval District; previously with the Western Electric research laboratory; also former head of a Radio Institute; radio instructor at the Seagate and N. Y. Herald Radio Stations; and in charge of Ground Radio at Montauk Point Air Station.

I chose Felix and Diehl to write this first C-W C:

Because, amateurs since boyhood, they know amateurs' needs.

Because, both know the very latest discoveries in C-W.

Because, both know all the new kinks in C-W operation.

Because, both construct sets and teach others to do so.

Because, both know how to instruct as well as operate.

Because, both write, teach and lecture for amateurs.

See QST, Radio News, Wireless Age, Pacific Radio News.

Why I Raised a Rumpus with Them

Felix and Diehl first wrote this C-W C as a five book set. It was good stuff, elaborate with explanations and formulas.

But I knew no amateur would plow through five volumes.

So, I raised such a rumpus about it that they boiled it down to ten lessons in five booklets, written in simple language, without a single formula in all the explanatory work.

If you want good coal and tons of it, buy elsewhere!

If you want clear clean-cut diamonds, buy the C-W C!

BROWN LANDONE, 10th Floor, 15 West 44th Street, New York City

WHAT IS C-W C?

The FIRST and ONLY Presentation of C-W

By

Edgar H. Felix and William F. Diehl



W. F. DIEHL

What hook-up will work the best? Can I combine receiver and transmitter, so as not to buy another bulb?

How does the make of tube affect the choice of circuit? What will I gain if I use two tubes? How long will an X— tube last if I use 1.2 amperes filament current? 1.5?

These and a thousand other questions are answered in C-W C!

C-W C is not a mere set of booklets; it's a training course in instruction, construction, adjustment and operation.

This Is the First Simple and Complete Presentation of C-W

1. Vacuum tubes: Characteristics of each type and how to secure the best results with each. (Results of work of 40 radio engineers and experimenters summarized by Felix.)

2. Power: How to get the most out of your source of power; new wrinkles and money saving methods in adapting any type of power supply to any C-W set.

3. Transmitting circuits: The most efficient circuit for your tube and your special power supply. (Saves you delays in attaining results; prevents you from buying equipment not adapted to your station.)

4. Construction: How to construct a C-W set at least expense and secure maximum results. (Worked out by Diehl, Chief Engineer for Grebe.) Correct values of inductance, capacity, resistance, grid leaks, high frequency chokes, etc. An error in using any of these may burn out your tube.

5. Greatest Radiation and Longest Range: Entirely new practical methods of tuning and adjustment never before published for the amateur.

6. Auxiliary apparatus: Of great importance—practically nothing has previously been written on this subject.

I'll Tell You Frankly How I Run My Business and Why

To have a dual purpose: To render service and to make money.

To Render Service: I never offer a course to an unlimited number of students; for I know it's impossible to give real personal help to each student if there are a great number.

To Make Money: I always print a smaller number of courses than I can sell and sell them in quick time at least expense.

I have sold courses on other subjects for seven years. I have always issued courses limited to 1,000 students. The courses offered have always been over subscribed.

I could sell 5,000 C-W C's—in two years—costing me 24 months' advertising and 24 months' office expenses.

By my method, I can sell 1,000 C-W C's in the next 60 days. That means 2 months' advertising and office expenses. Quick sales to the best amateurs yield the greater profit. Thus I can profitably sell a good course at a very low price.

I do my business in this way because it's certain profit with no possibility of loss due to unsold left-over copies.

C-W C is a special course for a special class of amateurs. It would be poor business to print a larger number. 5,000 will want this course; I have but 1,000 for sale.

The Opportunity

Many courses cost \$80; this C-W course costs but \$10. (That pays for all booklets, special helps and charts.)

C-W C by preventing you from burning out tubes will save you twice its cost during the first 6 months of C-W operation.

C-W C by preventing you from buying unnecessary apparatus will save you four times its cost within one year.

Send your \$10 today and begin the course at once.

If hard up, send \$3 and I'll hold a course for you for 3 weeks; then send \$7 any time within three weeks.

But, if you can't dig up the \$7 in 3 weeks, I'll return your \$3, for I can sell that course to someone else.

From the service standpoint, I'd like to have the 1,000 courses go to the 1,000 amateurs who are most interested.

From business standpoint, it makes no difference if you or other fellow gets the set held for you.

SEND IN YOUR ORDER NOW FOR C-W C.

BROWN LANDONE, 10th Floor, 15 West 44th Street, New York City

Mr. Brown Landone, 10th floor,
15 West 44th St., New York City.

Enclosed please find:

\$10, for which please send me a C-W C; or \$3,
to reserve a C-W C for 3 weeks, in accordance
with QST ad.

Name

Street

City State.....

ESCO

GENERATORS — MOTOR-GENERATORS — DYNAMOTORS

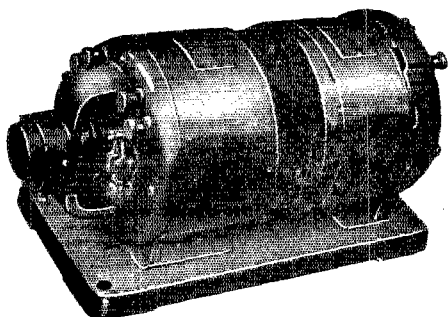

4 to 32 Volts for Filament.
350 to 2000 Volts for Plate
Capacity 20 to 2000 Watts

LIBERAL RATINGS

*Write for Bulletin #231 Which Lists
200 Combinations.*

Motors and Generators Developed and
Built for Special Purposes.

Pioneers in the Manufacture of High
Voltage Direct Current Radio Generators.

ELECTRIC SPECIALTY CO.

215 SOUTH STREET

STAMFORD, CONN., U. S. A.

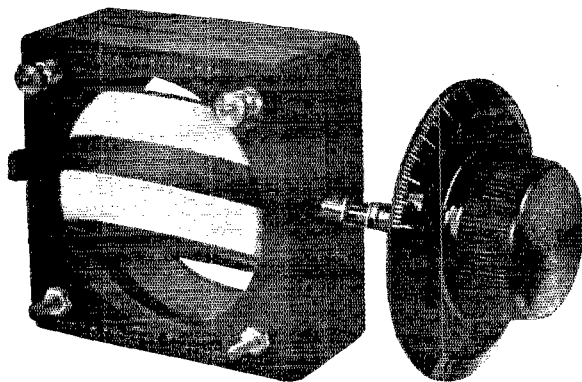
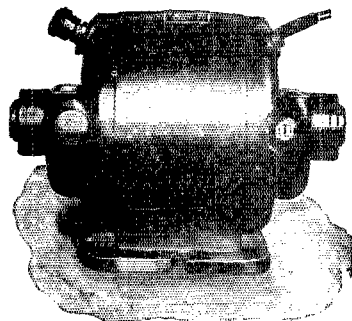

TUSKA Moulded

Variometer

**MECHANICALLY AND
ELECTRICALLY PEERLESS**

TYPE 200.

PRICE \$7.25

SEE THEM AT YOUR DEALER'S

| OTHERS | INDUCTANCE | | DISTRIBUTIVE CAPACITY | |
|---------------|---------------|---------------|-----------------------|--------------|
| | MINIMUM | MAXIMUM | MINIMUM | MAXIMUM |
| No. 1. | 70.3 m.h. | 940 m.h. | 8.4 mmf. | 44.1 mmf |
| No. 2* | 75 " | 440 " | 22.8 " | 60. " |
| TUSKA° | 70.0 " | 1560 " | 14.0 " | 55. " |

*Coil wound on OUTSIDE of moulded form. Notice the large distributive capacity for range.

*Think how EXTREMELY low the DISTRIBUTIVE CAPACITY is in the TUSKA VARIOMETER compared with the EXCEPTIONALLY WIDE range.

Send 5c for C.W. and Variometer Booklets

THE C. D. TUSKA CO., HARTFORD, CONN.

SHRAMCO - R E O -

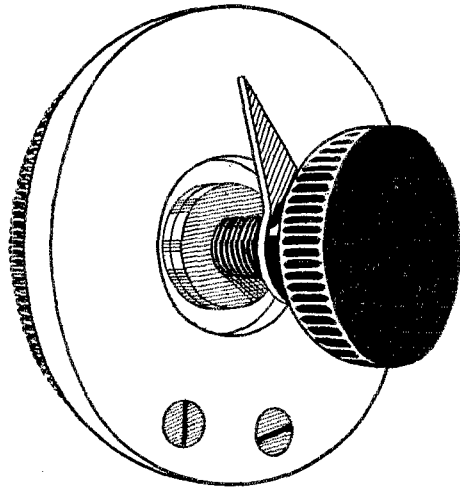
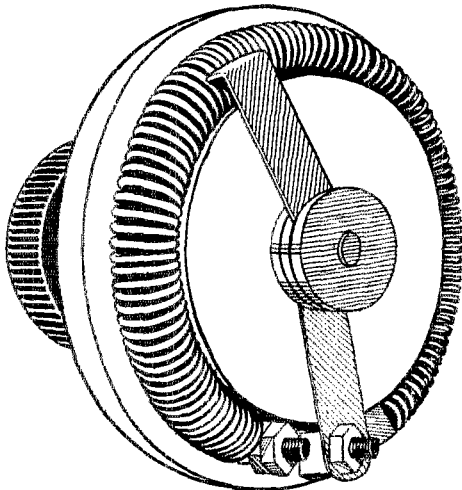

for your power tube--

New type Shramco Reo, No. 90P.

1.5 ohm Nichrome resistance.

Current capacity 6 amperes

Price \$2.00, 1 lb. postage.

A BACK MOUNTED panel rheostat, specially designed for the Radio U.V. 202 and other transmitting tubes. Resistance element (1.5 ohm) is "Nichrome" wire, mounted on a solid block of asbestos. Allows unusually accurate and delicate variation of the filament current. All metal parts brass. Spring

phosphor bronze blade. Base 3". Overall height 2½". Handsomely finished and accompanied by an unconditional guarantee of complete satisfaction. Get the most out of your expensive power tube by using a good rheostat. Order a Shramco Reo to-day! Now ready for immediate shipment.

for your VT detector

and amplifier, use the original Shramco Reo, type 90. Similar to the power tube type, but with a "Nichrome" resistance of 6 ohms. Price, \$2.00, plus postage for 1 lb. We also make the "Midget" Shramco Reo, 5 ohm resistance, 2½" base.

SHOTTON RADIO MFG. COMPANY, INC.
P. O. BOX 3, SCRANTON, PA.

Catalogue "K", listing a complete line of high grade parts at reasonable prices, sent to any reader of QST for five cents in stamps.

**YOU CAN NOW BUY "CONNECTICUT" RADIO EQUIPMENT
DIRECT FROM MANUFACTURER**

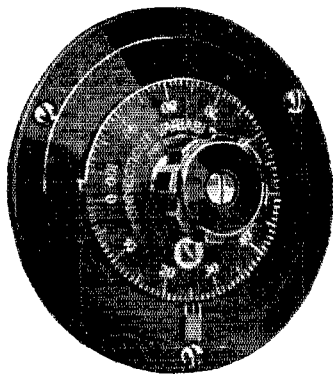

**CONNECTICUT
Variable Condenser**

Compact. Simple. 360 degree adjustment. Unusual signal strength. Portable or Panel type\$6.50

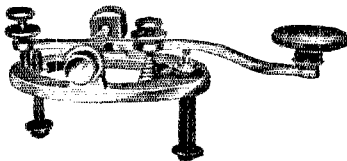

CONNECTICUT Sending Keys
For low power stations
10-W: as illustrated.....\$3.00
11-W: without mounting screws 2.75

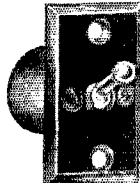

**CONNECTICUT
Toggle Switch**

For receiving panel
75-Y: one gang.....35c.
55-Y: two gang.....70c.



**CONNECTICUT
Head Receivers**

U. S. Govt. Standard. Lightest. Strongest. Most easily adjusted.
1856-A with 2000 ohm receivers and 6-ft. cord.....\$6.00
1857-A: with 3000 ohm receivers and 6-ft. cord.... 6.50
5014-W: head band only.... 2.00

Prices F. O. B. Meriden. Send for literature descriptive of our complete line of Radio Apparatus and Supplies. Amateur inquiries especially invited.

CONNECTICUT TELEPHONE & ELECTRIC COMPANY
Meriden Connecticut

**Federal Standard Radio Accessories
Are Recommended and Endorsed by the Leading Radio
Engineers and Amateur Experimenters of the Country.**

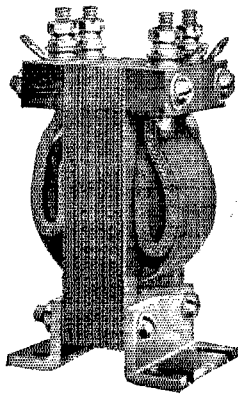

**No. 226-W
Audio-Frequency
Transformer**

Federal No. 226-W Audio Frequency Transformer gives the **Maximum Amplification** with all types of Standard Tubes now on the market.

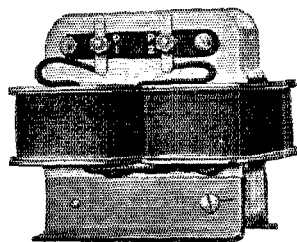

**No. 300-W
800 M. A. Filter Coil**

Federal No. 300-W Filter coil for smoothing out the Pulsations in the D.C. Plate Voltage Supply in Radiophone Circuits.

It is unquestionably the most effective filter coil on the market.

Ask your dealer for Federal products. If he does not have them, tell us his name.

Federal Telephone and Telegraph Co.
Buffalo, N. Y.

Manufacturers of Standard Radio Accessories. Send for Bulletin 102-W.B. & C. Circular.

RAC-3 AUDION

Price
AUDION
and
RECEPTACLE
\$4.50



AUDIO
FREQUENCY
AMPLIFIER

RADIO
FREQUENCY
AMPLIFIER

AUDION
OSCILLATOR

Full Size

FIRST UNIVERSAL AUDION

Manufactured under DeForest Patents No. 841,387 and No. 879,532

RADIO AUDION COMPANY

90 Oakland Avenue,

Jersey City, New Jersey

No Radio outfit up to date without the RAC-3 Audion. No need for buying "soft" or "hard" tubes.

RAC-3 Audions are interchangeable without necessitating critical readjustments.

RAC-3 Audions are not critical to A or B battery adjustments.

Low battery consumption. Filament current 0.8 amp. at 4 volts, maximum. Plate voltage 2 to 22 volts.

Clear signals and great sensitiveness on long distance reception.

Perfect oscillation for use in regenerative circuits.

Small size. Rigid construction. Non-microphonic. No tube noises due to mechanical vibration.

Maximum insulation between filament plate and grid terminals resulting from new type of tube and receptacle.

No soldered audion terminals.

Maximum direct mechanical contact between audion leads and receptacle clips.

Audion base caps and Receptacle block moulded Grade A Condensite.

Receptacle block is designed to permit built-up panel construction for amplifier panel. Circuit connections may be made from front, back or sides.

If your dealer is not carrying RAC-3 Audions in stock, send attached coupon.

Mail Order Coupon

Radio Audion Company,
90 Oakland Avenue, Jersey City, N. J.

Enter my order for.....RAC-3 Audions and.....Receptacles for shipment by return mail. Forward by Parcel Post insured. Enclosed herewith is Postal Money Order for \$.....plus 10 cents for postage and insurance.

Name Address

City State

ALWAYS MENTION Q S T WHEN WRITING TO ADVERTISERS

Fellows! Only three weeks more before

The First National A.R.R.L. Convention and Radio Show

THROUGH the many years of amateur radio there has developed an increasing desire to meet the other fellows that are, like yourself, interested in radio communication either as a pastime or business. And now comes a time when your wishes shall be gratified.

For, in Chicago on August 30, 31, September 1, 2 and 3, 1921, the American Radio Relay League will hold a First National Convention and Radio Show, which everyone is cordially invited to attend.

Chicago is itself a wonderful summer resort, offering every opportunity in any sport or diversion. You will never regret having spent part of your vacation here. The details of the convention are exceedingly comprehensive and every minute of the convention will be taken up with interesting and educational conferences and lectures, being in all a most complete and co-ordinated program. Mornings, afternoons and evenings are fully arranged for, so that you will remember this convention as some of the most enjoyable days of your life.

There will be people that you know and many that you do not know that will be present from every district and city in this great United States. Probably the most important feature of the convention will be the huge banquet on the night of September 3rd, and there should be none failing to attend. Everybody from the Young Squirt up to President Harding will be there to pass you the sugar and tell you what a record station he or she is going to have this season.

The first day will be given over entirely to the arrival, registration and locating of the many delegates. The program will start promptly at ten A.M. August 31st, so you should arrange to be in Chicago some time during the previous day, August 30th.

We have arranged to accommodate you at the finest hotels in the city, very close to all activities, at rates from two dollars per day up.

From the moment that each delegate arrives, and they should not forget to bring the ladies, until their departure, the utmost of consideration will be devoted to their safety, comfort and pleasure.

Convention delegates will be admitted to the meetings, lectures, sportive expeditions and the Radio Show without any charge.

Banquet charges will be five dollars per plate, and reservations should be made immediately with convention reservation manager.

N. C. BOS
118 No. La Salle Street
Chicago, Illinois

(Make all remittances payable to Chicago Executive Radio Council.)

MAKE YOUR RESERVATIONS NOW!

Mr. Manufacturer and Dealer

This is your final chance to grasp an opportunity of a lifetime

---exhibit at

THE FIRST NATIONAL RADIO SHOW

Broadway Armory, Chicago

August Thirty-First to September Third

THE manufacturers and dealers' exhibit at the First National Radio Show, which is to be held in conjunction with the convention, will be the most spectacular conglomeration of modern radio equipment that has ever been put on display under one roof. This gorgeous and pompous affair will be well worth the trip itself.

The Broadway Armory, the most modern and largest exhibit and convention building in Chicago, will be used entirely for this great show.

Divided into model exhibit booths and beautifully decorated in one accord, it will equal in splendor any of the successful automobile shows. The magnitude of the affair is positively stupendous.

It will indeed be a great thing for the manufacturer and dealer, as it is held at a time that marks the opening of a new and more active radio season. Business conditions are rapidly improving and very successful season is predicted.

In addition to publicity thru radio publications, circulars and placards, the daily newspapers with circulation over the million mark will be employed to advertise the show. This should result in a daily attendance of anywhere from three to eight thousand of interested people. The results to the advertisers, both direct and indirect, will be unprecedented.

This is not a money making proposition and the booths are being sold on approximately a pro-rata basis. The convention delegates will be admitted without charge, and the general public will pay an admission fee. Permanent passes will be issued to exhibitors. The show will open at the same time as the convention, ten A.M. August 31st, and everything must be in readiness the day before.

Here are some reasons why every manufacturer and dealer should be an exhibitor: It is the biggest affair that has ever been promoted in the age of radio. It comes at a time that marks the opening of the regular radio season. There will probably be over ten thousand people reviewing the apparatus. By personal contact with the field which he is selling he may gain good will. The exhibit cost is low and the results will be big.

Your competitor may have an exhibit and if you do not—well, think it over.

There will be every accommodation available for the exhibitor, delegates and the general public. The Armory is conveniently located near the three hotels at which the majority of the delegates will stop. There are also excellent amateur stations near by which will supply both spark and phone transmission for the reception of exhibitors.

It will be a long while before such opportunities as are here offered will again be presented.

You are urged to address at once the show director,

N. E. WUNDERLICH

4533 No. Sawyer Avenue

Chicago, Illinois

MAKE YOUR RESERVATIONS NOW!

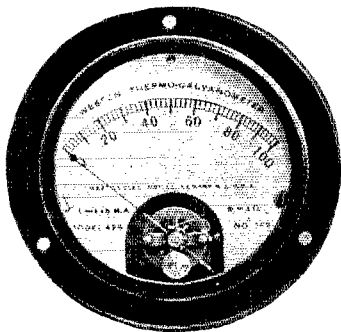

Scale length 2.35"
 Body diameter 2 3/8"
 Flange diameter 3 1/4"
 Approx. Weight, 0.4 lbs.
 Finish—Dull Black
 50 Scale Divisions

Are You Obtaining Reliable Results From Your Wavemeter?

* You can and will if it is equipped with the

Weston

Model 425

THERMO-GALVANOMETER

OR

Current Squared Meter

This is a miniature size instrument especially designed to render the most accurate wavemeter service.

Its current consumption is very small—only 115 milliamperes being required for full scale deflection.

Its resistance is exceptionally low—4 ohms.

The scale is uniformly divided so that the indication is proportional to the square of the current flowing.

Its high sensitivity makes it ideal for wavemeter application.

It costs little more than inferior substitutes. May we send you further information?

It is the instrument you need.

WESTON ELECTRICAL INSTRUMENT COMPANY

158 Weston Avenue, Waverly Park.

Newark, N. J.

Branches in all Principal Cities.

SAG-RE-CO- PRODUCTS

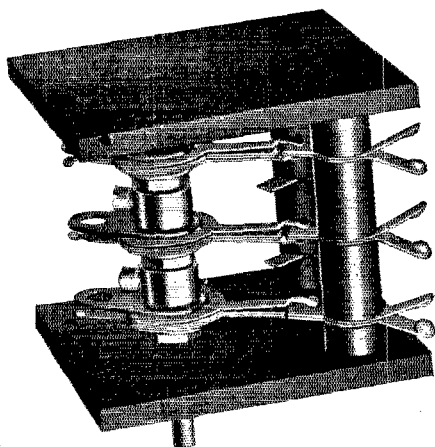

Back Mounted Rotary Switch. Used for master switch employing bakelite insulation.

Price \$4.00

Improved Spark Gap—entirely machined product. Provision made for interchangeable and renewable teeth. 9" O.D.—teeth 1/16" x 1" special aluminum alloy. XX grade bakelite insulation. See cut in June QST

Introductory price \$15.00.

Our mail order dept. can make immediate shipment on all standard radio tel. and tel. equipment with prompt service.

We handle the following and many other makes of equipment.

Clapp-Eastham
 Electroze Mfg.
 Chelsea
 Federal
 Remler
 Adams-Morgan
 Murdock

Acme
 Brandes
 John Firth
 General Radio
 DeForest
 Continental Fibre
 Radio Corp. of Am.

Saginaw Radio & Electric Co.

118 SO. WATER STREET,

SAGINAW, MICHIGAN

Important Reductions in Prices of Thordarson Apparatus

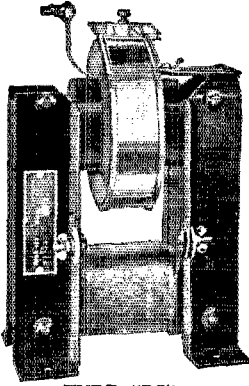

TYPE "RS"
TRANSFORMER

Type "RS" Transformers

A non-resonant transformer with a lower secondary potential designed to give you the highest possible power factor.

| | |
|--------------------------|---------|
| 1 KVA 15000 VOLTS..... | \$30.00 |
| 1/2 KVA 10000 VOLTS..... | 20.00 |
| 1/4 KVA 8000 VOLTS..... | 15.00 |

Type "R" Transformers

The famous resonant transformer affording the highest practical voltages.

| | |
|--------------------------|---------|
| 1 KVA 25000 VOLTS..... | \$40.00 |
| 3/4 KVA 10000 VOLTS..... | 28.00 |
| 1/2 KVA 10000 VOLTS..... | 22.00 |

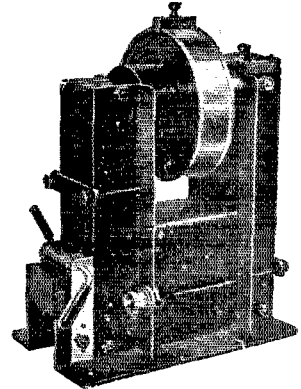

TYPE "R"
TRANSFORMER

Other Thordarson Equipment

| | |
|--------------------------------------|---------|
| POWER CONDENSER (.0018-.009 MF)..... | \$25.00 |
| OSCILLATION TRANSFORMER | 10.00 |
| R8 ROTOR (8 TOOTH)..... | 5.00 |
| R16 ROTOR (16 TOOTH)..... | 5.00 |
| R12 ROTOR (12 TOOTH)..... | 3.00 |

(Specify diameter of motor shaft when ordering rotors.)

A POSTAL BRINGS OUR CIRCULAR TO YOU.

Thordarson Electric Manufacturing Co.

517 S. JEFFERSON ST.,

CHICAGO, ILL.



EVENTUAL APPARATUS

It is only a matter of time before all real amateurs and experimenters will reach that stage where at least one item of their equipment must be the best obtainable. It is then that they will turn to "WICONY" equipment—if not before. This is why "WICONY" equipment is called "EVENTUAL APPARATUS."

To the amateur—as to all others—we sell only our high grade commercial and Governmental type of equipment. It costs somewhat more, but is much less expensive than the types designed especially to meet the average amateur's pocket book.

It is the kind you will eventually buy—so why not now?

Address Inquiries To

PACENT ELECTRIC COMPANY

DISTRIBUTORS

150 Nassau Street,

New York, N. Y.

OR

WIRELESS IMPROVEMENT COMPANY

(Manufacturers)

66 YORK STREET,

JERSEY CITY, N. J.

DO YOU KNOW?

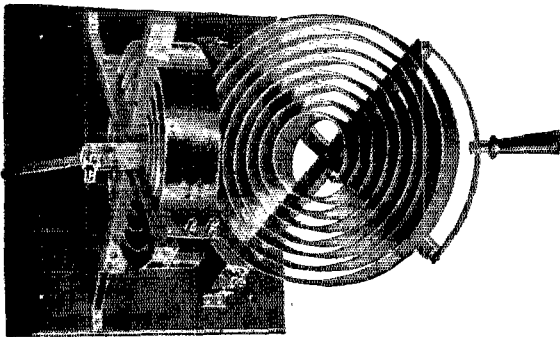

DX-52 PRICE \$25.00

That the current put into your oscillation transformer often exceeds the 2000 ampere mark? That if your O. T. is not wound with sufficiently large ribbon this current will be lost due to the resistance of the small ribbon?

Our DX-52 oscillation transformer is built to take care of this enormous current, being wound with $2\frac{3}{4}$ " phosphor bronze ribbon, 4 turns on the primary and 8 turns on the secondary.

Aside from that it has bakelite insulation thruout thus insuring you against possible leakage due to poor insulation.

Another feature is that the coupling is adjustable while transmitting or testing allowing you to keep an eye on the radiation meter.

4 large $1\frac{1}{2}$ " wide clips are furnished free with this instrument DX-52 Price \$25 This is the O. T. used by 8ZR in their trans-continental transmission to 6EJ, 6AK and 7ZJ.

Don't forget our DX-51 Spark Gap and C.W. power motor advertized in the March issue of Q S T. Price \$30.00.

Write for our latest bulletin.

THE AMERICAN RADIO SALES & SERVICE CO.

GREAT AMERICAN BUILDING

MANSFIELD, OHIO

Testing Station 8ZR

ALWAYS MENTION Q S T WHEN WRITING TO ADVERTISERS

HERE'S \$5 FOR YOU!

An Offer Without Any Strings

In order to start things going with a bang this fall we will credit \$5.00 on every order for one of our Z-Nith Regenerators or Amplifigons, Type AGN-2 when such orders are sent direct to us, **accompanied by the attached coupon.** Only one of each of these incomparable instruments sold to any individual on this offer.

The new type Z-Nith Regenerator, equipped with long wave attachment with maximum of 1000 meters and 180 degree coupling adjustment. The best regenerative receiver on the market today for spark, CW or radiophone reception.

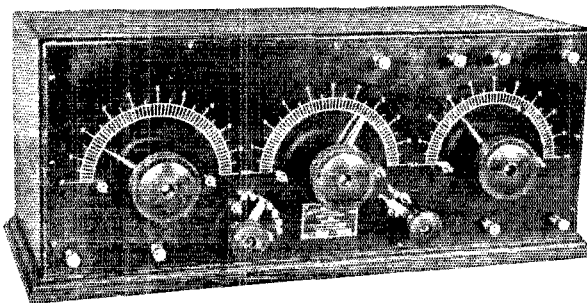

Z-NITH REGENERATOR

Regular Price \$55.00 with coupon \$50.00

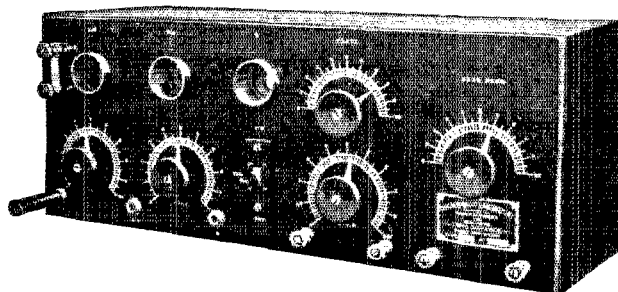

Z-NITH AMPLIFIGON, TYPE AGN-2

Regular Price \$89.25 with coupon \$84.25.

The new type Amplifigon Detector - Amplifier Type AGN-2, equipped with special high voltage cut-off switch, non-squealing amplifying transformers, variable grid condenser and plate potentiometer. Ideal for use with any tuner or regenerative receiver on the market.

THIS OFFER GOOD ONLY DURING MONTH OF AUGUST

Write now for Bulletin F-21 describing these instruments and take advantage of this opportunity.

Chicago Radio Laboratory

6433 Ravenswood Ave.,

Chicago, Ills.

THIS COUPON WORTH \$5.00

C. R. L.
6433 Ravenswood Ave.,
Chicago, Ill.

Gentlemen:—

In accordance with your wonderful August offer enclosed find \$.....
for which send me one.....

Name

Address

Town

FORMICA

Sheets, Rods, Tubes

Made From Anhydrous
Redmanol Resins

Insist on getting the best insulating material in your equipment and apparatus.

FORMICA is approved by the Bureau of Engineering, U. S. Navy, and is used by the leading manufacturers of radio apparatus.

Highest Insulation Resistance
Lowest Power Losses
Splendid Appearance
Excellent Machining Qualities

The following dealers can supply you with FORMICA sheets, tubes and rods.

Manhattan Electrical Supply Co.,
17 Park Place, New York, N. Y.

Clapp-Eastham Company,
139 Main St., Cambridge, Massachusetts.

The Radio Electric Company
3807 Fifth Ave., Pittsburgh, Pa.

Pennsylvania Wireless Mfg. Co.,
507 Florence Ave., New Castle, Pa.

Radioelectric Company,
919 Huron Road, Cleveland, Ohio.

The Wireless Manufacturing Co.,
Canton, Ohio

The Precision Equipment Co.,
2437 Gilbert Ave., Cincinnati, Ohio

Detroit Electric Company
434 Shelby Street, Detroit, Michigan

The Wireless Shop,
511 West Washington St.,
Los Angeles, California

Leo J. Meyberg Company,
428 Market St., San Francisco, Cal.

The Formica Insulation Co.
CINCINNATI, OHIO.

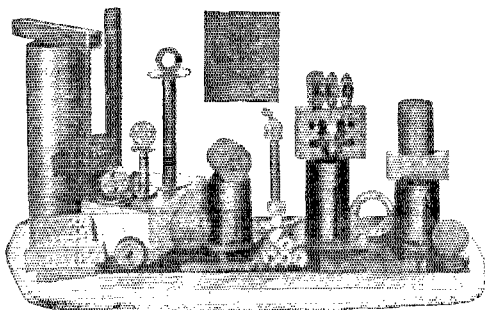

Universal "VERNIER" Attachment

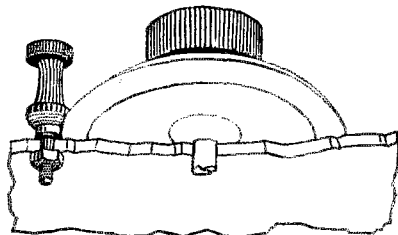

Patent Applied For

There is no set in existence that is not improved wonderfully by the addition of this little device. In tuning CW and radiophones, a difficulty often experienced with the standard condenser is the impossibility of securing that exact adjustment required to bring in the music clearly, and free of troublesome and disconcerting back-wave screeches. In receiving spark stations on regenerative sets using variometers, it serves to secure a maximum regeneration and still not allow the set to spill over. With the standard dial all these troubles are experienced time and time again. The K-35 Vernier Attachment eliminates this. After a coarse adjustment by means of the dial, the little vernier button is pressed forward, and a slight turn either way, as needed, serves to bring in a maximum signal of clearness not obtainable by the first adjustment. Actual measurements show that it will tune 10 to 15 times more accurate than a straight dial adjustment. Think of making your receiving set more than ten times as efficient at a cost representing a fractional percentage of its original price.

K-35 Vernier Attachment, complete.

45c or 6 for \$2.50

All sizes of honeycomb and duolateral coils, fully mounted, at regular catalog prices less 25%.

K-30 Rotary Spark Gap\$10.50

Open type with ten point wide tooth rotor. Steel shafts and pressure feed grease cups on both bearings.

K-31 Panel Mount Rheostats\$1.35

K-32 Amplifying Transformers\$3.75
3 for \$10.35.

\$1,667.00 Deforest 1/2 K.W. Oscillon Radiophone transmitter, complete with motor generator and bulb. Reason for selling, installing 1 K.W. set. Guaranteed in good as new condition. Bulb only burned 75 hours. Write for details.
Priced, F. O. B. Rock Island \$1,100.00

Karlowa Radio Co.

606-11-514 Best Bldg. Rock Island, Ill.

Send 5c for our 55-page Spark and Receiving Equipment Catalog, 4c for C.W. catalog, or 7c for both.

**MAIL ORDER
"SERVICE"**

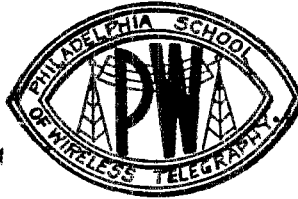

**WE SHIP SAME
DAY ORDER IS
RECEIVED**

Reg. U.S. Trade Mark.

Our large stock of all reliable makes of Radio apparatus enables us to make immediate Shipment of your orders.

ANTENNA SWITCHES

Murdock, 3 pounds.....\$4.50
Clapp-Eastham, 10 pounds.....12.50

AERIAL WIRE

7x22 tinned copper
100 feet 2 lbs.....\$1.25
200 feet 4 lbs.....2.40
500 feet 8 lbs.....6.00

AMPLIFYING TRANSFORMERS

A.R. Co. (1 lb.).....\$5.00
Federal (1lb).....7.50

"B" BATTERIES

Radiaco No. 1 (2 lbs.).....\$1.50
Radiaco No. 5 (5 lbs.).....2.65
Eveready Storage Battery
prices on application

CONDENSERS TRANSMITTING. (Dubilier)

No. D-100 250 W. 10,000 V. .007 MF....\$19.00
No. D-101 500 W. 14,000 V. .007 MF....30.00
No. D-102 1000 W. 21,000 V. .007 MF...45.00

CONDENSERS (Low voltage)

Western Electric 1MF 500 Volts.....\$1.50
Western Electric 2MF 500 Volts.....2.25
No. 21AA Western Elec. 1000 Volts A.C. 2.50
No. 577 Dubliers .002 1000 V.2.00

CONTACT POINTS

CP No. 1, Brass, dozen.....25c
CP No. 4, Brass, dozen.....35c
CP No. 5, Nickel Plated.....45c
Postpaid

CORWIN DIALS

No. 66, 3".....\$0.75
No. 67, 3" with knob.....1.30
No. 68, 3 1/2".....1.00
No. 69, 3 1/2" with knob.....1.70
Postpaid

GRID CONDENSERS

Radiaco, Postage 3c.....35c

GROUND OUTFIT

Consists of SPDT 500 AMP Switch, 25 feet No. 4 wire, clamp and cleats prepaid.....\$7.00

JACKS AND PLUGS

Federal Closed Circuit.....\$0.25
Federal Open Circuit......70
Federal Double Circuit.....1.00
Federal Plug.....2.00
Postpaid

LOOSE COUPLERS

Clapp-Eastham Radion.....\$14.00
Murdock 344.....9.00
8 pounds.

OSCILLATION TRANSFORMERS

Radiaco No. 5.....\$15.00
Via. Express collect only

ROTARY SWITCHES

Clapp-Eastham No. 19.....\$1.00
Clapp-Eastham No. 19A......35
Corwin No. 1......40
Corwin No. 2......55
Postage......05

REGENERATIVE RECEIVERS

No. CR-1 Grebe 175-680 Meters.....\$90.00
No. CR-2 Grebe 175-680 Meters.....45.00
No. CR-3 Grebe "Relay Special" 175-680 Meters.....65.00
No. CR-3A Grebe With tube control, 175-375 Meters.....45.50
No. CR-5 Grebe's "Super-Special" 175-3,000 meters, tube control, self-contained. Complete receiving set. Just out.....80.00

RECEIVERS

Murdock No. 55, 2000 ohm.....\$4.50
Murdock No. 55, 3000 ohm.....5.50
Brandea Superior.....7.00
Baldwin C.....16.50
Baldwin E., improved.....20.00
Brownlie new.....12.00
Shipping weight, 2 pounds

RADIO CRAFTS PRODUCTS

Detector.....\$15.00
Two step Amplifier.....50.00
Detector and one step.....45.00
Detector and two step.....70.00
Postage Paid

Regen. Receiver, 150-600 M.....\$60.00
Regen. Receiver, long wave type.....145.00

TUSKA C.W. APPARATUS

181 Coll (2 lbs).....\$7.50
182 Coll (2 lbs).....10.00
183 Coll (3 lbs).....12.50
170 Filtr. (8 lbs).....16.00

VACUUM TUBES

No. UV-200 Radiotron, detector.....\$5.00
NO. UV-201 Radiotron, amplifier.....6.50
UV 202 Radiotron, 5W. power.....8.00
UV 203 Radiotron, 50W. power.....30.00
UV 204 Radiotron 250W. power.....110.00

VARIABLE CONDENSERS

A.R.CO. .001.....\$6.25
A.R.CO. .0005.....5.00
With No. 67 Dial add.....1.00
Murdock 366.....4.75
Murdock 367.....4.75
Murdock 368.....3.75
Clapp-Eastham 800.....7.50
Clapp-Eastham 800A.....9.50
Clapp-Eastham 800B.....11.50
Complete with dial
Shipping Weight One Pound

VARIOMETERS

Radiaco No. 1.....\$7.00
Radiaco No. 1D.....8.50
3 pounds

VARIO-COUPLER

Radiaco No. 3.....\$7.50
Radiaco No. 3D.....8.50
3 pounds

Philadelphia School of Wireless Telegraphy

Note New Address

1533 Pine St., Philadelphia

A NEW KENNEDY VARIOCOUPLER

Another Mark of Progress

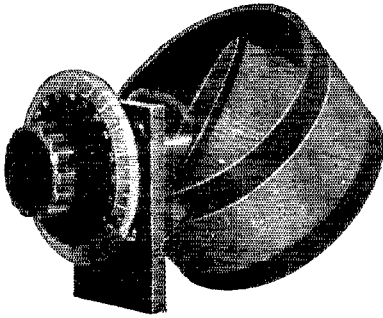

Possesses many outstanding features among which are:

1. Coupling variable progressively through an arc of 180 degrees.
2. Pigtailed connections to rotor. No sliding contacts.
3. Secondary mounted concentrically within primary.
4. Primary inductance provides for single turn variation.
5. Light and compact but strong and rugged. (Weight only 12 ounces.)
6. Highest grade materials. Made of formica, brass and double cotton covered copper wire.

7. Minimum solid dielectric in electromagnetic field.

8. PRICE \$7.50

With Kennedy bakelite knob and dial as illustrated 8.75

THE COLIN B. KENNEDY COMPANY

INCORPORATED

RIALTO BUILDING

SAN FRANCISCO

STOCK REDUCTION SALE—ALL PRICES SLASHED

In order to reduce our enormous stock during the summer season we are offering the Radio amateurs bargains unheard of before. All of the equipment listed is of standard manufacture and is still being sold at the old prices by the manufacturers and other dealers. We simply are over-stocked and in order to secure room must sacrifice the apparatus at great price concessions. To show that this sale is bona fide we guarantee each article sold against any further price reductions for one year from date of sale. These prices will be effective from date of the issue of this magazine to date of following issue, in other words for one month only. All postage prepaid during this sale.

RHAMSTINE* Amplifying Transformer

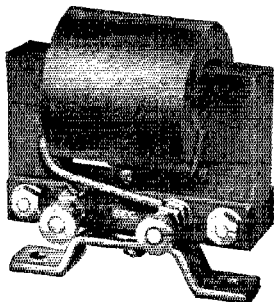

Regular price - - - \$3.50
 Sale price - - - \$3.25

| | List Price | Sale Price |
|---|------------|------------|
| Acme fully mounted 1 K.W. sending transformers.. | \$45.00 | \$40.00 |
| Acme fully mounted 1/2 K.W. sending transformers.. | 22.00 | 19.50 |
| Acme semi-mounted 1/2 K.W. sending transformers.. | 18.00 | 16.00 |
| Acme fully-mounted 1/4 K.W. sending transformers.. | 16.00 | 14.50 |
| Acme semi-mounted 1/4 K.W. sending transformers.. | 13.00 | 11.50 |
| Electrical Specialty #117 detector..... | 2.15 | 1.70 |
| Electrical Specialty #110 detector..... | 2.10 | 1.65 |
| Electrical Specialty #115 detector..... | 1.60 | 1.05 |
| Electrical Specialty M-480 2000 ohm receivers.. | 6.25 | 4.50 |
| Electrical Specialty M-481 3000 ohm receivers.. | 7.50 | 6.00 |
| Electrical Specialty L-104 Regenerative receiving transformer..... | 29.50 | 22.00 |
| Electrical Specialty L-103 Regenerative receiving transformer..... | 23.50 | 17.75 |
| Electrical Specialty L-102 "Standard" receiving transformer..... | 19.50 | 14.75 |
| Electrical Specialty Double slide tuning coil..... | 5.00 | 3.50 |
| Electrical Specialty #121 fixed condenser..... | 1.50 | 1.00 |
| Electrical Specialty #122 two capacity fixed condenser..... | 1.80 | 1.20 |
| Electrical Specialty #123 two capacity fixed condenser with switch..... | 2.50 | 1.85 |

Electrical Specialty L-103 Regenerative receiving transformer.....

Electrical Specialty L-102 "Standard" receiving transformer.....

Electrical Specialty Double slide tuning coil.....

Electrical Specialty #121 fixed condenser.....

Electrical Specialty #122 two capacity fixed condenser.....

Electrical Specialty #123 two capacity fixed condenser with switch.....

All DeForest condensers 25% discount from list prices

ELECTRICAL SPECIALTY CO., 48-50 South Front St., Columbus, O.

A New Advance in Wireless

You can feel a sense of absolute security when you protect your Vacuum Tubes with "RADECO" Safety Fuses. No matter what abnormal amperage is set up—or how, it is IMPOSSIBLE to burn any bulb filament out accidentally when you have the "RADECO" Safety Fuse on the terminals.

"RADECO" Safety Fuses are used by thousands of Radio men, both amateur and professional, in the United States and Canada.

At a few cents costs this small device prolongs the life of any Vacuum Tube indefinitely. Simple!—just slip fuse directly on the filament terminals of any standard bulb used in any standard socket. The "RADECO" Safety Fuse does not reduce the efficiency of your set.

"RADECO" Safety Fuses may also be used to protect meters and any other delicate electrical instruments.

We sell standard Radio equipment of every description. Order from any standard catalog. Immediate deliveries

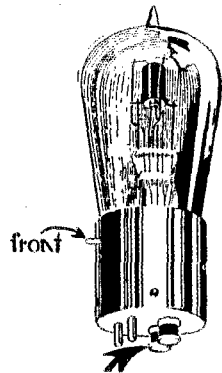

| Carrying Capacity | | |
|-------------------|------|--------|
| 3/4. | 1. | 1 1/4. |
| 1 1/2. | 2. | 2 1/2. |
| and | 3. | amp. |
| Size | 1/4 | inch |
| over | all. | |

Radio Equipment Co.

630 Washington St.

Boston, (4th floor) Mass.

Order By Mail

If your dealer cannot supply you with "RADECO" Safety Fuses pin one dollar to this advertisement, stating sizes wanted, and receive four fuses by return mail.

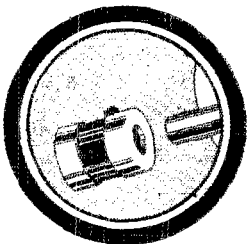

Patent Pending

"RADECO" Safety Fuse

You are far behind the times, and open every minute to loss, if your set is not equipped with a "RADECO" Safety Fuse. See your dealer today.

Sold by dealers

4 for \$1.00

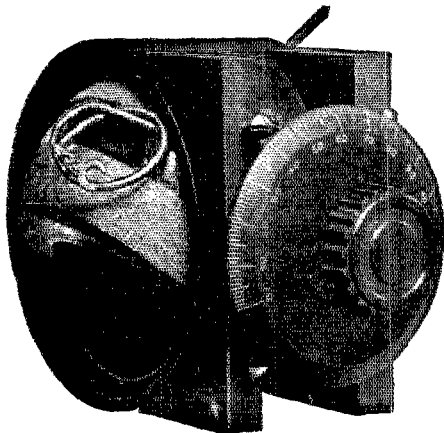

THE VARIOMETER

The now famous Z. K. V. Variometer has met with a tremendous sale, thousands being in use, by those who know the quality of Clapp-Eastham products.
 Complete with knob and dial.....\$6.50
 Without knob and dial..... 5.75
 Variocoupler to match with knob and dial 7.50

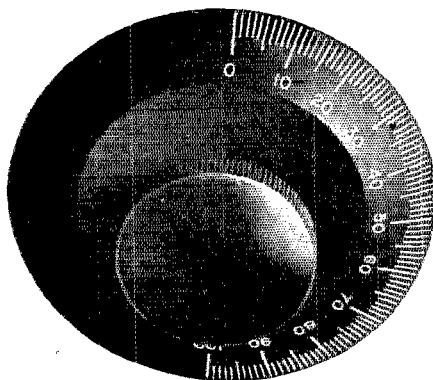

THE DIAL

This 3" knob and dial is our own product heavy brass dial black oxidized finish, composition knob 1 3/8" diameter. Supplied for 1/8" shaft only. This dial cannot chip or warp and will run true. Its beauty is in keeping with the best products of the instrument maker.
 Price dial and knob #F800H complete. \$.75

Complete catalogs sent for 6c stamps
 Patronize your local dealer; if he won't supply our material your order will receive immediate Factory attention.

CLAPP-EASTHAM CO., 114 Main St., Cambridge, Mass.
Headquarters for Radiotron Tubes. All types in stock.

C-W C-W C-W C-W C-W C-W C-W C-W

Prepare for the bad radio season by installing your CW outfit now, it will carry thru summer static and is ideal for relay work.

OUR C-W CATALOG
 WILL BE READY
 ABOUT MARCH 15th,
 SEND FOR YOUR
 COPY NOW.

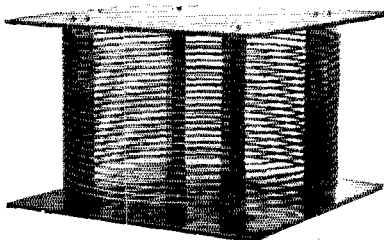

OUR NEW C-W
 CATALOG WILL
 BE THE MOST
 COMPLETE AND
 BIGGEST — CW
 ONLY.

CW Inductance No. CW-100 shown above, mounted on Formica exclusively—25 turns edgewise copper strip 3/16 x .050" complete with connection clips, \$10.00.

Send 15 cents for catalog, which amount may be deducted from first order of One Dollar or more.

"8ZV" WIRELESS MANUFACTURING CO. "8ZV"
CANTON, OHIO

"-- best I ever tried"

"The last vacuum tube you gave me I find that it works the best I ever tried, it also oscillates fine, and sure can hear C.W. and spark stations loud and clear. The filament works around $3\frac{3}{4}$ volts."—Signed Stephen F. Pitoniak, 12 Valley Rd., Albion Pl., April 25, 1921.

Use A.P. Tubes and you will be equally enthusiastic. Use A.P. Tubes for efficiency, use A.P. Tubes for sure results, use A.P. Tubes for better results. There is an A.P. Tube for every purpose. Use **only** A.P. Tubes.

A-P Tubes are licensed by the Radio Corporation of America under the DeForest Audion and Fleming patents for amateur and experimental use in Radio communication.

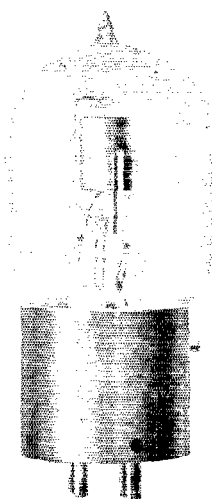

**THE A-P VT
AMPLIFIER-OSCILLATOR**
—the amplifier used by the
U. S. Navy. "Use the tube
the Navy uses." Price \$7.

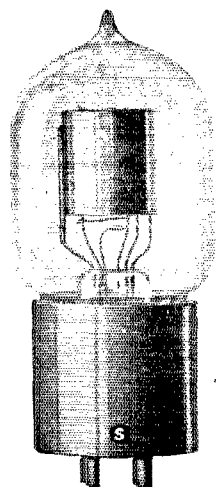

**THE A-P
ELECTRON RELAY**
—the most sensitive detec-
tor of spark signals known
to the radio art. Price \$6.

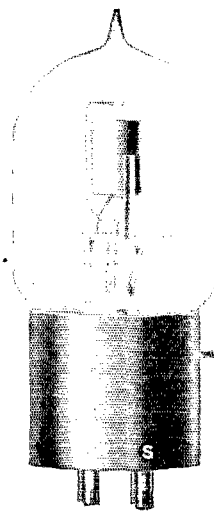

**THE A-P
TRANSMITTER TUBE**
—an efficient undamped
wave transmitter for use
in radio-telephony. Price
\$7.50.

Order from your dealer or write direct. And for the best book on Radio ask your dealer for "Elements of Radiotelegraphy," by Lieut. Ellery W. Stone, U. S. N., or order direct from—

The Atlantic Radio Supplies Co. 8 Kirk Place, Newark, N. J.
The Pacific Radio Supplies Co. 638 Mission St. San Francisco, Cal.

use A-P tubes for efficiency

CO-OPERATIVE RADIO PURCHASING

Members of this association participate in the profits which have accrued through their own and fellow amateurs combined purchases. In addition to this dividend our service is unexcelled. You also can secure this service and share

in our profits. Order direct from this ad or send a stamp for full particulars. Remember "We take pride in our service." The items listed below are but a few of the items which are carried in stock..

RADIOTRON TUBES
 UV-200 Gas Content Detector \$5.00
 UV-201 Photron Amplifier 6.50
 UV-202 5 Watt Transmitter 8.00
 (We supply full directions with either detector or amplifier.)

AMPLIFYING TRANSFORMERS
 Clapp-Eastham type QO unmounted 4.00
 Clapp-Eastham type QO mounted 6.50
 Acme A2 with binding posts 5.00
 Acme core & coil assembled 4.50
 Acme A2 fully mounted 7.00
 U.V. 712 List Price 7.00
 Mfg. by Radio Corp. of America.

CONDENSERS
 Connecticut .001 encased \$6.50
 Connecticut .001 panel type 6.50
 Chelsea No. 1 encased 5.00
 Chelsea No. 2 encased 4.50
 Chelsea No. 3BD with dial for panel 4.75

Chelsea No. 4BD with dial for panel 4.25
 Murdock No. 366 .001 encased 4.75
 Murdock No. 367 .0005 encased 4.50

TELEPHONES
 Brandes Superior with Navy Band \$8.00
 Brandes Trans-Atlantic with Navy Band 12.00
 Brandes Navy type with Navy Band 14.00
 Western Electric type 1002A 15.00
 Murdock No. 55, 2000 ohms 4.50
 Murdock No. 55, 3000 ohms 5.50

SHORT WAVE SET MATERIAL
 Clapp-Eastham ZRV Variometer, without dial \$5.75
 Clapp-Eastham ZRV Variometer with 3-inch dial 6.50
 Clapp-Eastham ZRC Variometer with knob & dial 7.50
 Clapp-Eastham ZRC Variometer, with switch and points 9.00
 J. J. Nightingale Variometer 4.50

J. J. Nightingale Variocoupler 5.00
 Murdock G or P Variometer No. 345 7.50
 Murdock Variocoupler No. 346 8.50

AUDION CONTROLS
 Clapp-Eastham ZRD detector panel \$12.00
 Acme Y-1 detector 10.00
 Adams Morgan No. 70 control 6.00

C. W. TRANSFORMERS
 Acme 200 watt mounted \$20.00
 Acme 50 watt mounted 15.00

MODULATION TRANSFORMERS
 Acme A-3 semi mounted \$5.00

CHOKE COILS
 150 M.A. Single coil \$4.00
 150 M.A. double coil 6.00
 500 M.A. single coil 6.00
 500 M.A. double coil 8.00

FILAMENT HEATING TRANSFORMERS
 75 watt mounted \$12.00
 150 watt mounted 16.00

MUTUAL PURCHASERS ASSOCIATION
 Dept. Q, 2 Stone Street, New York City

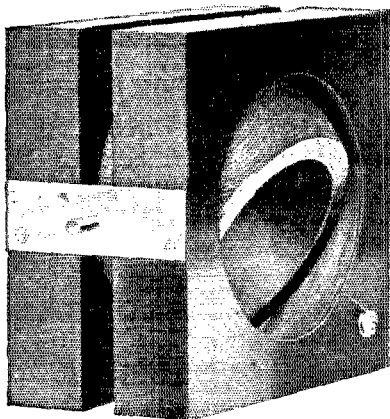

VARIO - COUPLERS Price

For panel mounting Rotor, hard wood, primary. Formica Tubing, tapped for 1 and 6 turns. Base included for table mounting. Brass bushings.

\$5

VARIOMETERS

only \$5.00

Rotor and Stator of hard maple, will not warp or shrink: brass bearings; accurately made. Size 4 $\frac{3}{4}$ "x4 $\frac{3}{4}$ "x3". Made in two sizes, 18 wire and 20 wire for plate and grid.

Wave length 150 to 750 meters.

Dealers Have You Our Proposition?

WIRELESS CATALOG

JUST OUT 10c in stamps or coin brings new loose-leaf catalog—150 pages giving C. W. Hook-ups and all instruments needed for wireless receiving and sending sets—a broad range of prices—places you on mailing list to receive regular bulletins, keeping you posted on latest developments in wireless telegraph and telephone. Illustrations and prices on latest MAGECO apparatus. Write today, 10c.

10^c

The Marshall-Gerken Co.

128 RADIO BUILDING,

TOLEDO, OHIO

Announcing the

VOCALLOUD

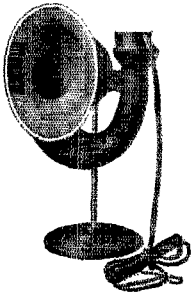
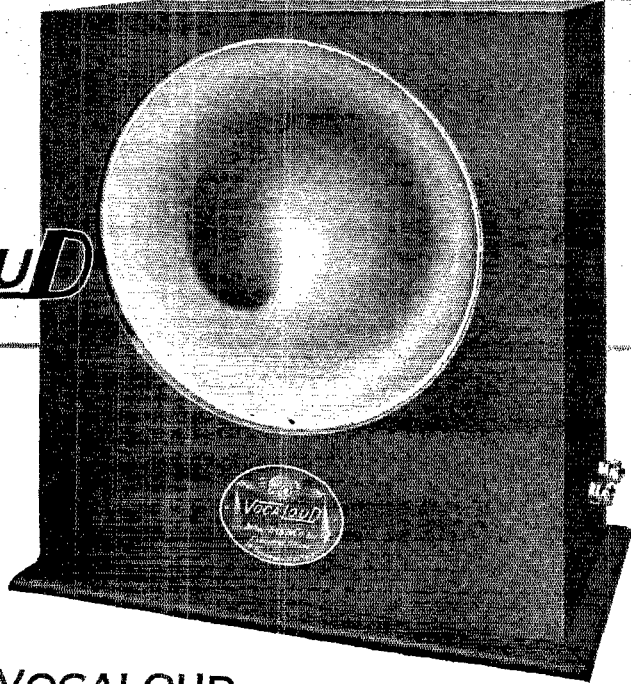

PRICES

Vocaloud, Station Type, in polished mahogany cabinet, as shown - - \$30.00

Vocaloud, Laboratory Type, mounted on adjustable base. \$25.00

Saco-Clad amplifying transformers, \$5.00

VOCALLOUD
and three steps of Saco-Clad amplification
pick up fight story clearly for 35 hearers.

ON THE afternoon of July 2nd, an amateur in Flushing, L. I. entertained 35 friends with the blow by blow story of the championship fight, direct from the ringside. He used 3 steps of Saco-Clad amplification and a Vocaloud. Every listener heard every move of Dempsey and Carpentier perfectly. Even the gong at the beginning and end of each round was clearly distinguished.

The Saco-Clad amplifying transformers produced *no howling whatever*. The Vocaloud *re-created* the words so perfectly that the speaker's voice was recognized.

For really amazing summer-time results *you too*, should use Saco-Clads and a Vocaloud. Every Saco-Clad is completely shielded by $\frac{1}{16}$ " of metal. There can be no magnetic leakage, and six steps have been used without howling.

Examine Vocaloud and Saco-Clad at your radio dealer's. Or send 2 cents for leaflets to

John Firth & Company, Inc., 18 Broadway, N. Y.



- FIRCO Audion Detectors and Amplifiers
- Radio Frequency Amplifiers
- High Voltage Units
(with any primary voltage)
- Baldwin Phones
- Fircoco Vocaloud
- Saco-Clad Transformer
- Fircoco Accessories
- Kolster Decremeter
- Seibt Scientific Instruments
- Eldredge Meters
(can usually calibrate)
- Brownlie Phones
(adjustable)

FIRCO RADIO

EQUIPMENT

"Pioneers—since 1901"

PRICE REDUCTION OF TUBE SOCKET

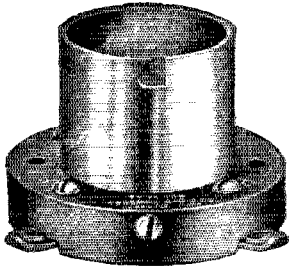

TYPE 156 SOCKET

The ever increasing demand for our universal tube socket has enabled us to reduce the cost of manufacture and correspondingly the sale price. The same high quality of material and workmanship will be rigidly adhered to.

These sockets are adapted to any of the standard American four prong transmitting or receiving tubes. They are adapted to the Western Electric VT-2 tubes as well as to the Radio-tron UV202 tubes. The contact springs are sufficiently rugged to carry the filament current of the five watt transmitting tubes without arcing.

**POSITIVE CONTACT SPRINGS
RUGGED, ATTRACTIVE, RELIABLE**

Price \$1.50

SEND FOR FREE RADIO BULLETIN 909Q.

General Radio Company

MASSACHUSETTS AVENUE AND WINDSOR STREET.

CAMBRIDGE, 39

MASSACHUSETTS

Standardize on General Radio Equipment Throughout.

POPULAR DEMAND!



Results in our placing before the Amateur the parts of the now famous "CINO" Regenerative Tuner, made Nationally famous in sixty days!

| | |
|---|--------|
| Variometer Forms only | \$2.50 |
| (2 Stators, 1 Rotor and winding form) | |
| Variometer wound, not assembled | 4.50 |
| Variometer completely assembled | 6.00 |
| Variocoupler parts | 2.50 |
| Variocoupler completely assembled | 6.50 |
| Formica panel drilled and engraved | 5.00 |
| 14 Contacts56c. 2 Switches | 1.20 |
| Option of Corwin or Chelsea dials at list | |
| CROSLY PORCELAIN SOCKET | .60 |
| Winding specifications and drawings furnished. | |

We carry complete line of Standard accessories.

CINO RADIO MFG. COMPANY

218 West 12th Street.

CINCINNATI, OHIO.



KENOTRON RECTIFICATION FOR C.W. TUBE TRANSMISSION

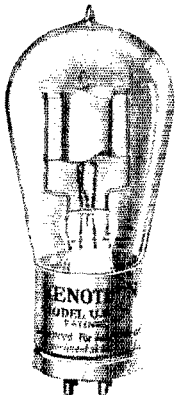

**KENOTRON
U.V. 216**
20-Watt Output
PRICE, \$7.50

THE least expensive and the most satisfactory method of obtaining a direct-current source for plate-excitation is the use of A. C. with Rectifier Valves.

Two types are available for use with Radiotrons.

Kenotron Model U.V. 216 is especially designed to operate with Radiotron U.V. 202, the 5-watt transmitting tube. Filament requires 7.5 volts at 2.35 amperes. The A. C. input is 550 volts. The output of this rectifier tube is 20 watts at 350 volts D. C.

Kenotron Model U.V. 217 is designed to operate with Radiotron U.V. 203, the 50-watt tube. The Filament requires 20 volts at 6.5. The A. C. input is 1250 volts. The output of this rectifier tube is 150 watts at 1000 volts D. C.

Our Standard Porcelain Socket, Model U. R. 542 at \$1.00 will fit Kenotron U.V. 216, while a larger socket of the same type, Model U. R. 541, price \$2.50, is required for Kenotron U.V. 217.

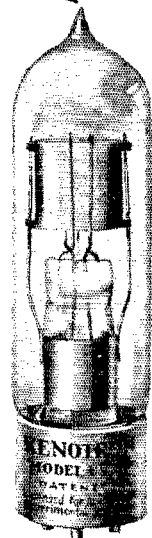

**KENOTRON
U.V. 217**
150-Watt Output
PRICE, \$26.50

The Radio Corporation's tubes are covered by patents dated November 7th, 1905, January 15th, 1907, and February 18th, 1908, as well as by other patents issued and pending. Tubes licensed for amateur and experimental work only. Any other use will constitute an infringement.

A complete line of radio telegraph and telephone sets for amateur purposes will soon be on the market.

For detailed data see your nearest dealer or write direct to

Radio Corporation
of America
WORLD WIDE WIRELESS

Sales Division, Commercial Department, Suite 1803
233 Broadway, New York City

J-RAY VARIOMETERS

We regret that cut of our IMPROVED Variometer is not available for this issue. Faultlessly and accurately turned out of non-shrinking MAHOGANY wood, this new variometer fully upholds the J-Ray standard of perfection. Inductance ample for 600 meters. Offered in both complete and knocked down form at the following prices:

| | |
|---|-------------|
| Complete Variometer, Unwound | Each \$1.90 |
| Same wound, but unassembled (grid or plate) | 3.80 |
| Variocoupler, primary tube (Formica) wound and tapped | 1.75 |
| Variocoupler, secondary ball, unwound | .75 |
| Same wound | 1.30 |

Complete Variometer, \$5.00. Variocoupler, \$4.75

You can save 75% of the cost of your receiver by winding your own variometers. Full winding directions with each set. Dealers write for exceptionally attractive proposition.

SPECIAL OFFER OF AERIAL WIRE

While it lasts, No. 14 pure Copper Antenna Wire, 80 ft. per lb. per lb. \$0.38.

We will appreciate your order for Radio Supplies—Prompt Service.

J-RAY MFG. CO. 2131 De Kalb St. St. Louis, Mo.

Manufacturers of Improved Radio Apparatus.

Write for Rotary Spark Gap Bulletin 1, Illustrating 4 types of Improved Rotary Gaps.

OMAHA

Now has a good Up-to-Date stock of

WIRELESS

Apparatus and Supplies.

We are AMRAD stock dealers

also a good line of Aerial Equipment, A.A. Transformers, Brandes, Baldwin, DeForest, Federal, Firth, G. A., Murdock, Radio Corp., Remler and Thordarson Apparatus and parts.

Genuine Bakelite Panels cut to any size, in $\frac{1}{8}$ ", $\frac{3}{16}$ " and $\frac{1}{4}$ " thickness at 2c, 3c and 4c per square inch.

WOLFE ELECTRIC CO.

313-S. 17th St.

Phone Atlantic 1414

ANNOUNCING

Opening of the New Salesroom
and Laboratory

of

RAY-DI-CO

the

"HOUSE OF BETTER RADIO"

Saturday, August 20th., 1921

where a complete line of standard apparatus, parts and materials will be carried.

To the amateurs we extend a hearty invitation to call and "get acquainted."

Mail Orders Given Prompt Attention.

RAY-DI-CO

(Ray-Dee-Ko)

1547-D N. Wells St. Radio 9AG Chicago, Ill.

"We'll look for you at the First National Convention, Aug. 30-Sept. 3rd., Chicago."



**EASTERN
RADIO**

TEL.
BACK BAY
5 9 6 4

899 BOYLSTON ST.
BOSTON, MASS.

INSTITUTE



SUMMER CLASSES !

This year the EASTERN RADIO INSTITUTE will conduct their SUMMER CLASSES as usual. New students may begin to advantage in the DAY or EVENING school on any Monday. Special effort will be made to give every possible assistance to those desiring to accomplish the work during the Summer months and in this respect our DAY school offers unusual advantages.

For the last few months we have been telling you of the "RESULTS" accomplished by the EASTERN RADIO INSTITUTE. This month we want to tell you of its "ADVANTAGES."

"RELIABILITY"

Founded in 1913. Ninth Successful Year.

"FACULTY"

All Experienced Radio Men.
Each Instructor a Specialist in His Department.

"EQUIPMENT"

Latest Spark, Arc, and Wireless Telephone Sets.
Only School in New England with "Federal Arc Transmitter."

"INSTRUCTION"

The most Systematic, Comprehensive and BEST Radio Course of Any School in the East.
Only School in New England giving "Arc" Instruction upon Actual Apparatus.

"POSITIONS"

Successful graduates of the EASTERN RADIO INSTITUTE are found in responsible radio positions all over the World—Radio Inspectors, Superintendents, Shipping Board Radio Supervisors, Engineers, etc.

"SERVICE"

Remember—Our Organization with over EIGHT years of Continued RESULTS and SUCCESS is behind every student who enrolls. If you want to become a Commercial Radio Operator let us train you. Just join our SUMMER CLASSES!

Our latest illustrated prospectus is free. If you cannot visit the Institute send for one.
F. D. PITTS, Director.

THE THING THAT APPEALS TO EVERYONE IS SERVICE

WE ARE PLEASED TO ANNOUNCE THE OPENING OF
A NEW SALESROOM IN LOS ANGELES

Leo J. Meyberg Co.

We issue a 200-page
Wireless Catalog. It's
yours for 35c in stamps
which will be refunded
with your first \$1.50
purchase from us.

THE LARGEST AND
MOST COMPLETE
STOCK OF RADIO
APPARATUS ON THE
PACIFIC COAST.

752 SOUTH LOS ANGELES ST.
LOS ANGELES, CAL.

428 MARKET ST.
SAN FRANCISCO

LONG LIFE—CLEAR RECEIVING

are the features of

BURGESS "B" BATTERIES

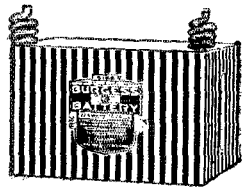

All sizes from the Navy type down to the
Baby "B." With and without taps

Send for catalogue

BURGESS BATTERY COMPANY

Harris Trust Bldg.

::

::

CHICAGO

\$12.00

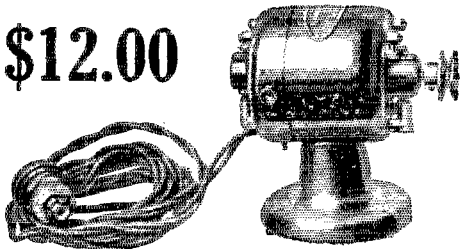

"Satisfaction Guaranteed."

Empyrean Radio Company

We have a limited number of
SPECIAL SPARK GAP MOTORS

Complete as Illustrated.

110 volts
1-12 H. P.
1/4" shaft.

Specify
A. C. or D. C.

\$12.00

Post-
paid
U. S. A.

Laminated field
and Armature—
Heavy bronze
bearings—Quiet
running.

Send us your order at once before these
remarkable motors have all been sold.

159 N. State St.

Chicago, Ill.

Next month—something you'll eventually need—watch for it.

RADIO APPARATUS

Distributors of Reliable Radio Apparatus to Schools, Colleges,
Radio Clubs and Experimenters All Over the World!

"PITTSKO"

The Sign of Service!
All We Ask is a Chance
to Prove It!



"PITTSKO"

Service Reaches All
Over the World! Why
Not Let It Reach You?

RECEIVING APPARATUS AMPLIFYING TRANSFORMERS

No. UV-712 Radio Corporation, new type
..just out, very efficient..... \$7.00
No. 231-A General Radio, new type..... 5.00
No. 226-W Federal, mounted..... 7.00

AMPLIFIERS

No. BORK Grebe two step with automatic
filament control..... 55.00
No. BORD Grebe Det. and two step with
automatic filament control..... 75.00
No. Y-2 Acme in cabinet..... 13.00

AUDION CONTROL PANELS

No. BORB Grebe in cabinet, with tickler
connections..... 17.00
No. Y-1 Acme in cabinet..... 10.00
No. P-1 Paragon, moulded type, small
and compact..... 6.00

"B" BATTERIES

No. 7623 Standard, 22.5 V. small.... 1.80
No. 7625 Standard, 22.5 V. large..... 2.85
No. 7650 Standard, 22.5 V. variable.... 3.50
No. 763 Everready, 22.5 V. small..... 2.25
No. 766 Everready, 22.5 V. large..... 3.50
No. 766 Everready, new type 22.5 V.
variable..... 3.00

CONDENSERS (Fixed mica type)

No. ROCC Grebe .0002 MF..... 1.00
No. ROCD Grebe .0005 MF..... 1.20
No. ROCE Grebe .001 MF..... 1.60
No. ROCF Grebe .005 MF..... 3.80
No. ROCA Grebe .0002 MF and .5 meg.
leak..... 1.20
No. ROCB Grebe .002 MF and 2 meg.
leak..... 1.20

DIALS

No. 41 Chelsea bakelite dial, 1/4" or 3/8"
shaft..... 1.00
No. F-800-H Clapp Eastham, new type,
just out, bakelite finish..... .75
No. T-1 Tuska, 4" dia. Bakelite, new
type, just out..... 1.50

DETECTORS, (Crystal)

No. D-101 DeForest, dustproof..... 2.80
No. RPDA Grebe, dustproof..... 2.75
No. 8854 Jove..... 1.80

GRID LEAKS

No. MW-1 Radio Corporation 1/2, 1, 1.5, 2
3 and 5 megohms, complete each.... 1.25
Grid leaks only..... .75
Bases only..... .50

REGENERATIVE RECEIVERS

No. CR-3 Grebe "Relay Special" 175-680
meters..... 85.00
No. CR-3A Grebe 175-875 meters with
tube control, complete set..... 45.50
No. CR-5 Grebe "Super-special" 150-3000
meters, complete set, ideal for jewelers
for time signals..... 80.00
No. CR-6 Grebe 175-680 meters, Det. and
two step amp. self contained complete
set..... 200.00
No. CR-7 Grebe 500-20,000 meters "Long
Wave Special" complete set..... 210.00

"Let 'PITTSKO' products, super-service and delivery solve your Radio problems"

SEND US YOUR ORDERS TODAY!

Send ten cents in stamps for Catalog No. 22. Over 100 pages, over 150 illustrations, over 600 items
"PITTSKO" SERVICE REACHES ALL OVER THE WORLD! WHY NOT LET IT REACH YOU!

F. D. PITTS CO., INC.

12 PARK SQUARE

DEPT. A.

BOSTON, MASS., U. S. A.

(New England distributors of Grebe apparatus.
Always in stock.)

ANTENNA WIRE

"Pittsco" No. 14 Hard drawn copper, per
lb. (80 ft. per lb.)..... .50
1000 ft..... 5.00
"Pittsco" 7 strand No. 22 tinned copper,
stranded (65 ft. per lb.) per ft..... .01
1000 ft..... 8.50
"Pittsco" 7 strand No. 20 phos. bronze,
per ft..... .02
500 ft..... 8.50

RADIOPHONE AND C.W. APPARATUS

C.W. POWER TRANSFORMERS

Acme 50 Watt 350 Volts, mounted..... \$15.00
Acme 50 Watt 350 Volts, unmounted..... 12.00
Acme 200 Watt 350-550 Volts, mounted..... 20.00
Acme 200 Watt 350-550 Volts, unmounted..... 15.00
Acme 500 W 1000-1500 V. mounted..... 25.00
Acme 500 W 1000-1500 V. unmounted..... 20.00

CHOKO COILS

Acme single coil 150 M. A. capacity.... 4.00
Acme single coil 500 M. A. capacity.... 6.00
Acme double coil 150 M. A. capacity.... 6.00
Acme double coil 500 M. A. capacity.... 8.00

CONDENSERS (Variable)

No. 3 Chelsea .0011 Mfd. unmounted.... 4.75
No. 4 Chelsea .0006 Mfd. unmounted.... 4.25
No. 182-G General Radio .001 Mfd. un-
mounted..... 9.75
No. 366-Int. Murdock .001 Mfd. unmtd. 4.25

FILAMENT HEATING TRANSFORMERS

Acme 75 Watt, latest type, mounted.... 12.00
Acme 75 Watt, latest type, unmounted 9.00
Acme 150 Watt, latest type, mounted.... 16.00
Acme 150 Watt, latest type, unmounted 13.00

FILTERS

No. 170 Tuska type..... 16.00

INDUCTANCES, C.W.

No. 181 Tuska Cap. feed-back circuit... 7.50
No. 182 Tuska, split filament..... 10.00
No. 183 Tuska Grid tickler..... 12.50

METERS

No. 127 General Radio, Hot wire, flush,
.5, 1, 2.5, 5, and 10 Amps..... 7.75
Model 301 Weston, D. C. meters, flush,
0-100, 300, 500 and 800 milli-amps.... 8.50
0-1, 2, 3, 5 and 10 Amperes..... 8.50

MICROPHONE TRANSMITTERS

No. 323-W Western Electric..... 3.95
No. 323-W Western Electric, with bracket 4.50
No. 5176-A Connecticut, with Adj. arm... 4.00
No. HM-100 DeForest, hand type..... 6.00

MODULATION TRANSFORMER

Acme A-3 semi-mounted..... 5.00
Acme A-3 fully mounted..... 7.00
No. 231 General Radio, new type..... 5.00

MOTOR GENERATORS

International 100 W. 500 V. A.C. Drive 99.00
International 100 W. 500 V. D.C. Drive.. 110.00

RESISTANCES

Type HS Ward Leonard 5,000 ohms..... 2.25
Type HS Ward Leonard 10,000 ohms..... 3.50

A WELCOME MESSAGE TO MANUFACTURERS AND DEALERS "The Leader" Prices Again Reduced

Effective Aug. 1, 1921.

Recent reductions in raw materials and the increasing demands from the trade have so materially reduced our manufacturing costs, that we are able at this time to make another attractive reduction, affecting both styles of these unique posts.

News of this reduction will not only be welcomed by the large number of manufacturers who have already adopted "THE LEADER" as standard equipment, but will be of special interest to other manufacturers who are now considering their adoption.

A SPECIAL AND TIMELY NOTICE!



Corporal



Sergeant

Mr. Manufacturer: To Manufacturers who are now considering "THE LEADER'S" adoption and who expect to exhibit at the CHICAGO RADIO CONVENTION here is your chance to equip your display apparatus with these novel posts.

Mr. Dealer: We want you to exhibit "THE LEADER" at the Chicago Convention. Kindly write us immediately for our special introductory Sales Proposition, also for pamphlets for distribution.

Mr. Amateur: When you attend the Convention do not fail to ask any dealer to show you these novel posts. One look at them will convince you that they are the only post for your set.

Manufacturers and Dealers write us now for our latest prices—then place your orders covering **YOUR FALL REQUIREMENTS**

DESIGNED RIGHT STAY TIGHT SELL ON SIGHT

THE H. H. EBY MFG. CO., 1302 Wallace St., Philadelphia, Pa.



"ENSIGN"
1/2" size. With plain neck.



"COMMANDER"
3/4" size. Hole to take #12 wire

Audiotrons

Genuine Two Filament Audiotrons

\$6.00

We have been able to obtain a last and final supply of Genuine Two Filament Audiotrons which we are offering for \$6.00. As the last demand was so great we would advise those desiring them to order at once.

We carry a full supply of the following makes:—Radio Corporation, Cunningham, Remler, Murdock, Acme, Federal, Clapp-Eastham, DeForest, Moorhead, Baldwin, Audiotron Mfg. Co., Bowman, Chelsea, Grebe, Amrad and others.

QUALITY plus SERVICE gives SATISFACTION—Try us and See.

**WHITALL ELECTRIC CO.
WESTERLY, RHODE ISLAND**

Sound Method for Memorizing the Code

New Method Better Results

Easiest, quickest and most thorough ever devised for learning without instruments.

If you want to learn the code—
If you want to "cinch" the signals you can't remember easily—
If you want to help some one else learn the code—

GET ONE OF THESE CARDS.

Don't try to teach the Ears through the Eyes. This system teaches the signals as they come through the Head Phones.

Contain both Continental and American Morse—Printed on Celluloid—

Price 50c.

**WIRELESS PRESS, Inc.
326-Q BROADWAY NEW YORK**

"Chi-Rad" Variometers & Couplers

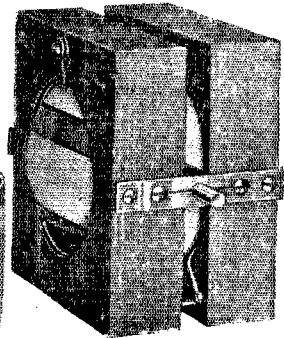
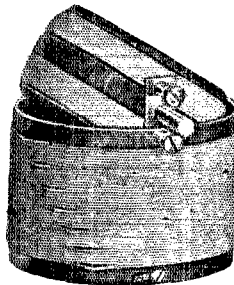
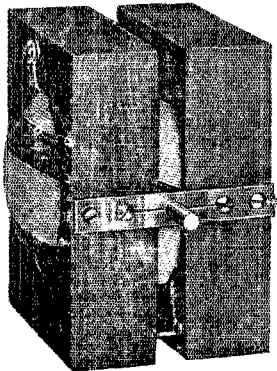

PLATE VARIOMETER

\$5.00 (3 lbs.)

COUPLER

\$4.00 (2 lbs.)

GRID VARIOMETER

\$5.00 (3 lbs.)

Prices, completely assembled as shown. Include P.P. on weight given.

SPECIAL KNOCKED DOWN PARTS

The knocked down set includes all the parts to make up two variometers and one coupler exactly as shown above. All windings in place, nothing to do but screw on bearings and connect up. Set can be assembled in 30 minutes. Price complete, only \$10.00. Add PP on 6 lbs.

READ THESE SPECIFICATIONS:

Variometer forms $4\frac{3}{4}$ " square, 3" wide when assembled.

Coupler primary $3\frac{3}{8}$ " diameter, $3\frac{3}{4}$ " high.

All shafts $\frac{1}{4}$ " diameter.

Made specially for panel mounting—all screws covered by dials when assembled.

Range 175-450 meters. Special condenser to shunt across secondary and increase range to 650 meters supplied for 35c extra.

Accessories to complete your Receiver

| | | | |
|--|---------|--------------------------------|--------|
| Bakelite Panel 7"x18"x $\frac{1}{8}$ " thick | \$1.75. | $\frac{1}{8}$ " in. thick..... | \$2.75 |
| "Chi-Rad" special panel switch, nicked bushing..... | | | .60 |
| Hard Rubber Binding Posts, each 12c., per doz..... | | | 1.25 |
| Nicked Switch Contacts $\frac{1}{4}$ "x $\frac{1}{8}$ ", per doz..... | | | .40 |
| "Chi-Rad" Mica Grid Condensers each 35c., 3 for..... | | | 1.00 |
| #16 bare tinned copper wire, 2 feet for..... | | | .01 |
| Empire tubing (spagetti), per ft. | | | .08 |
| "Chi-Rad" Universal Pointer with bushing..... | | | 1.25 |
| Chelsea Indicating Dials $\frac{1}{4}$ " or $\frac{1}{8}$ " shaft..... | | | 1.00 |

These Variometer & Coupler parts are fully guaranteed as to material, workmanship and operating characteristics. On both the assembled and knocked down instruments all windings are in place, the wire being secured in the variometer stators by a special process so the winding will never become loose.

Order a set of these instruments, assemble and test them on spark, phone or C.W. signals. If after ten days you are not more than pleased by their performance return them and we will immediately refund your money. **IMMEDIATE DELIVERY**—order your set today! *Dealers:* Write for discounts.

We carry a complete stock of all standard makes of Radio Apparatus and every order is shipped immediately. Try our "Chi-Rad" Service. Don't fail to see our big exhibit at the big A.R.R.L. Convention and First National Radio Show—we'll have several surprises for you.

Chicago Radio Apparatus Co., Inc.

Phone Harrison 1716

508 SO. DEARBORN ST.,

CHICAGO, ILL.

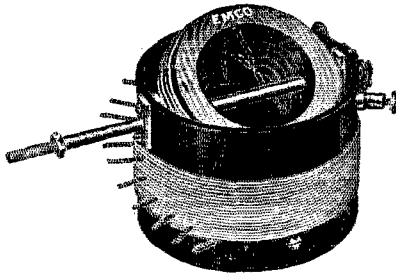

\$7.00

EACH

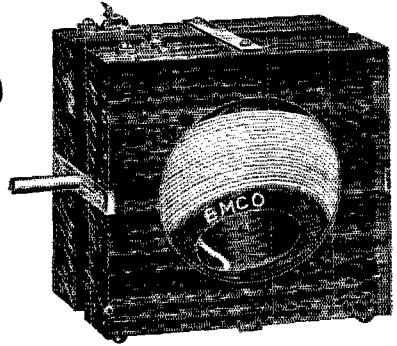

E. M. C. O. VARIOCOUPLER

This Variocoupler is an instrument combining the best operating efficiency with the highest quality of workmanship. The Primary is wound on a Bakelite tube grade X X and is so tapped that by means of two sets of switches a one turn variation of inductance may be obtained. The shaft is hollow through which flexible leads are run which connect to the rotor. This is a decided advantage as the contact does not depend upon the bearings. The shaft is provided with stops which allow a 90° adjustment of coupling.

E. M. C. O. VARIOMETER

This Variometer is made from the best materials obtainable. The stator forms are solid mahogany which will not shrink. The windings are specially treated to prevent their loosening while at the same time keep their distributed capacity at a minimum. The shafts are 1/4" brass rod and the bearings are split brass. Fahenstock clips are provided for connection.

Two E. M. C. O. variometers and one E. M. C. O. Variocoupler constitute a short wave set that is unexcelled for long distance work on wave lengths of between 150 and 500 meters.

DAVID KILLOCH CO.,

57 Murray Street, New York, N.Y.

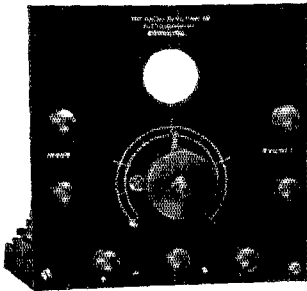

THE RADIO ELECTRIC COMPANY AUDION CONTROL

Detector Panel **\$9.50**

Amplifier Panel **\$13.50**

Send for circular describing our audion apparatus.

THE RADIO ELECTRIC COMPANY
3807 Fifth Ave., S. Pittsburgh, Pa.

Get a Copy of Our Wireless Manual H-12

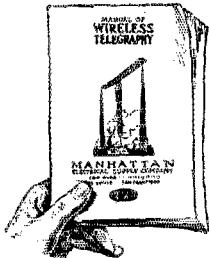

It contains 200 pages, fully illustrating and describing the many instruments used in Radio service. Forty-five pages are devoted to general instructions, diagrams, station calls, tables, codes and other information identified with the art. The book is printed on highly finished paper with a two-color cover; size 9x5 1/2 inches.

We ask 25 cents for it, give a coupon receipt for the amount which coupon when returned with an order will be credited at 25 cents.

With a large and varied supply of wireless instruments and accessories carried in stock, we are in position to fill any order or meet any condition promptly and accurately.

We have experts in charge of our wireless departments, so do not hesitate to consult us about your wireless problems. Proper attention and accurate information is yours for the asking.

MANHATTAN ELECTRICAL SUPPLY CO., Inc.

17 Park Place, New York; 114 So. Wells St., Chicago; 1106 Pine St., St. Louis; 604 Mission St., Frisco

Something Concise:

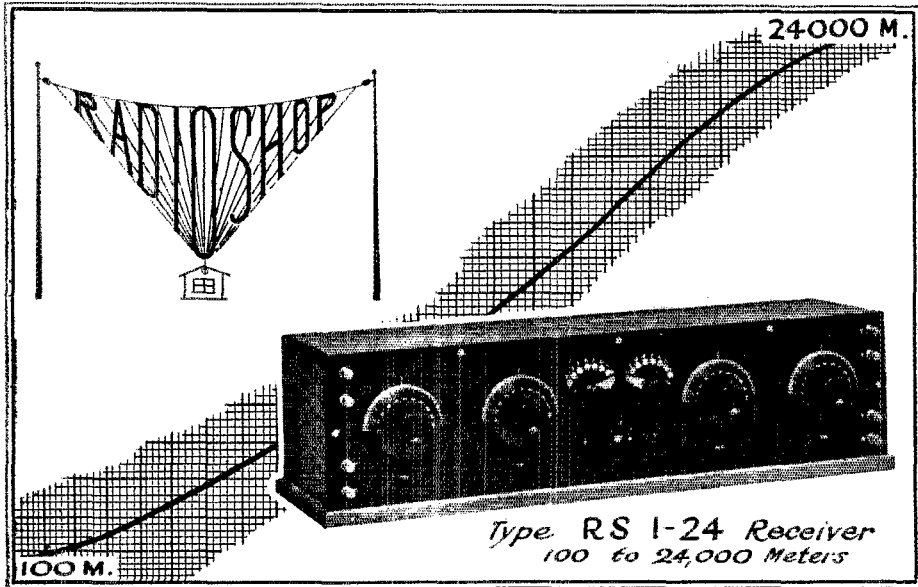

Concentrated essence of efficiency, the new RADIO SHOP type RS 1-24 receiver. The latest application of regenerative tuning to a range spanning every wavelength used in radio communication throughout the World.

Haven't you ever tired of the "QRM" on amateur wave-lengths and wished for a receiver that would bring in the commercial ships and long wave damped and undamped stations, without the trouble of changing wires and plugging in and out of numerous coils?

This is it! 100 to 24,000 meters, without a "dead spot," all in one cabinet! Variometer tuning applied to the entire scale with the resultant ease of control of regeneration and oscillation. Circuits so synchronized that troublesome "combinations" of tuning are entirely eliminated, making definite adjustments and reliable reception an assured thing and the RS 1-24 the ideal receiver for all wavelengths, with absolutely no sacrifice of efficiency on any particular wavelength. A "stand-by" arrangement is also incorporated that will broaden tuning, when so desired, for general "listening in" work.

The very popular RADIO SHOP short wave receiver construction applied to wavelengths below 1,000 meters assures maximum selectivity and efficiency for amateur and short wave commercial spark and C.W. reception. Wavelengths from 1,000 to 24,000 meters are taken care of by an entirely new application of the variometer principle which has already been employed in the RADIO SHOP long wave receiver, described in previous advertisements. The result:—SATISFACTION.

A few mechanical features that will appeal to the most exacting:—Banked windings. Dials that run true. Heavy bus-bar wiring. Non-shorting variable condensers. Grained, engraved, Formica panel. Interior as well as exterior workmanship of the highest possible order. NO SEALS. We are as proud of our interior as of the outward appearance and want the purchaser to know just as much about the apparatus as we do.

The "RS 1-24" carries the same "money back if not satisfied" guarantee that applies to all RADIO SHOP products. So far we have never had to live up to this guarantee, an enviable record to say the least.

"THE SET THAT YOU WILL EVENTUALLY BUY"

Licensed under Armstrong's Regenerative Patent and applying this unapproachable circuit to its maximum effectiveness.

THE RADIO SHOP type RS 1-24 Receiver is the most efficient and effective radio tuning device ever built.

PRICE, F.O.B. SAN JOSE, \$100.00

In ordering please specify whether Oak or Mahogany cabinet is desired.

Bulletins are now available describing this set in detail. We will gladly mail you a copy upon request.

DEALERS: We have an interesting proposition to offer you. Write us.

THE RADIO SHOP, San Jose, California

Variometers, \$5.75.

Vario-couplers, \$4.75.

A few still are left

Your Local Dealer probably carries WILCOX products in stock. IF NOT

Order by mail from us and your order will be shipped POSTPAID

Our new catalog is being mailed to our old customers. Others should send 5c for it.

The Wilcox Laboratories
Lansing, Michigan

It's easy—

to build your own variometers and regenerative sets with WILCOX parts and you'll save a heap of money too.

Type 1C Variocoupler Parts

A few minutes of pleasant work and you will have this efficient variocoupler assembled on your panel. Please note that our offer includes dial, switches, binding posts, etc.



- No. ICPI contains all parts as illustrated.....\$5.00
 No. 1CP2 Contains all parts illustrated, wound and assembled ready to mount on panel 7.00
 No. 1C1 Wooden Variocoupler Rotor, only 1.00

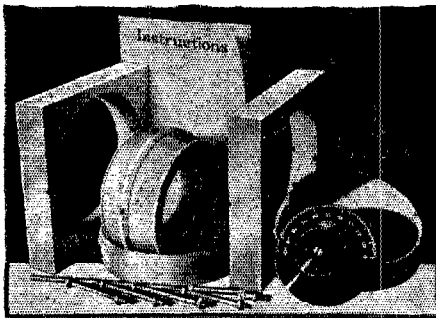

TYPE 5A VARIOMETER PARTS

With a few improvements these are the same high grade parts that have helped thousands of amateurs make their own variometers and regenerative receivers. The wooden parts are accurately turned from clear kiln-dried hardwood and all necessary holes are drilled. With the complete parts a special arrangement is provided which gives positive connection to the rotor winding without undue friction.

- No. 5AP2 Complete parts as illustrated\$4.25
 No. 5AP3 Complete parts less dial 3.00
 No. 5AP1 Wooden parts including winding form 2.00
 No. 5A Variometer completely assembled with dial 6.50
 without dial 5.25

Antenna Insulators

Will stand 500,000 volts after immersion in water for 48 hours. Tensile strength 2,000 pounds.

Longer Than the Insulator Sold as 10"
 Stronger Than the Insulator Sold as 10"

AND ONLY 90c APIECE

This price for August and September only.
 Buy 'em now for your new aerial.

Burgess #4156 22½ Volt "B" Batteries
\$1.75 Each
 While they last—Limited Supply.

- "73" Puncture Proof C.W. Condensers
- | | |
|-----------------------|--------|
| 1 Mfd 1500 Volts..... | \$4.00 |
| 2 Mfd 1500 Volts..... | 5.00 |
| 5 Mfd 1500 Volts..... | 10.00 |
| 2 Mfd 2500 Volts..... | 15.00 |
| 2 Mfd 4000 Volts..... | 23.00 |
| 5 Mfd 2500 Volts..... | 30.00 |

Write for descriptive Circular.

The Radioelectric Shop Co., Dept. Q.9.
 919 Huron Road Cleveland, Ohio

Back To Old Prices

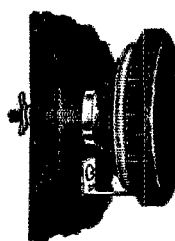

Parkin Rheostat

1000 Sold Last Year at \$1.00

NOW REDUCED TO

75 Cents

Due to the general drop in the prices of raw material and to our large production, we have been able to reduce all our prices to their pre-war level, and in some cases even lower. New catalog, No. 4, listing our complete line sent free.

Here are a few of the items:

- | | |
|--------|---|
| No. | Postpaid |
| 31 | Audion panel with rheostat and B Bat. Switch \$2.00 |
| 43 | 45 Volt Large B Battery 5.00 |
| 50 | Parkin .001mf Variable Condenser, unit only 1.50 |
| 51 | Parkin .001mf V.C. with knob and pointer 2.00 |
| 52 | Parkin .001mf V.C. with knob and 3" dial 2.50 |
| 53 | Parkin Molded Bakelite Fixed Condenser... .75 |
| UV-200 | New Radiotron Vacuum Tube..... 5.00 |

DEALERS—If you are not on our mailing list, write for new catalog and discounts.

PARKIN MFG. CO.

San Rafael,

Calif.

We Originate

Others Imitate

Knock 'Em Dead Get a Benwood Gap

Regardless of the many claims of our imitators we still manufacture the

FINEST ROTARY QUENCHED SPARK GAP

that has ever been made:—

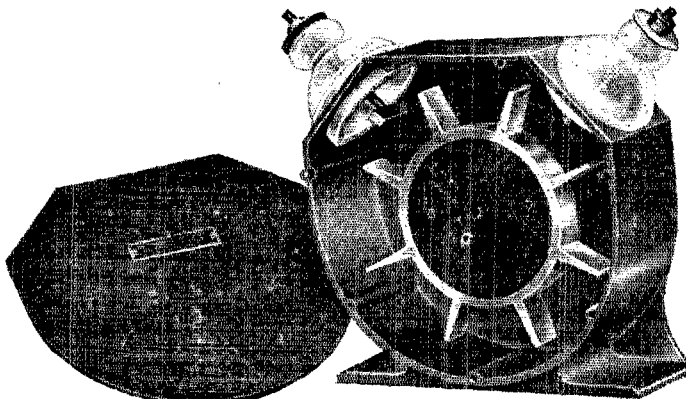

Note the many features:

- REMOVABLE POINT ROTOR
- GRAPHITE BEARING MACHINE STAMPED DISC
- GLASS INSULATORS
- VISIBLE SPARK
- DISC ONE INCH WIDE

PRICES REDUCED

This NEW BENWOOD SUPER gap is the Acme of perfection and has met with such great favor that we were hard put to keep up with the demand. They are now being produced on a quantity basis and IMMEDIATE DELIVERIES can be made.

WHY DO ALL REAL "DX" MEN USE THE BENWOOD GAP?
Because it is ABSOLUTELY the finest gap for real long distance work that has ever been made. We have just sold

800 BENWOODS

And they are all giving the utmost in service and efficiency. At the new low prices YOU can afford a BENWOOD GAP. The fall "distance season" has started so order your gap at once while IMMEDIATE deliveries can still be made.

Bakelite type, glass insulation \$22.00

Aluminum type, glass insulation \$28.00

VISIBLE SPARK INCREASED RADIATION ANY NOTE

Send for data on the NEW BENWOOD "SINK" GAP, \$60.00 complete

The Benwood Company, Inc.

Cor. 13th & Olive Streets,

ST. LOUIS., MO.

Using An Inefficient Condenser Is Like Carrying Water In A Sieve

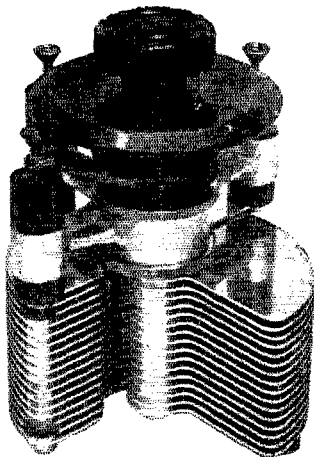

The same judgment used in the purchase of radio equipment that you use unconsciously in everyday affairs will invariably lead you to select COTOCO condensers. Users are unanimous in proclaiming them "the best."

This condenser used in conjunction with our inductance units will enable you to build a set that you will be proud to own.

If your dealer cannot supply you with our products, advise us, and send us his name

COTO-COIL CO. 87 Willard Ave., Providence, R. I.

10c. Charges Your Battery AT HOME WITH AN F-F Battery Booster

and your station will never be closed because of a discharged battery.

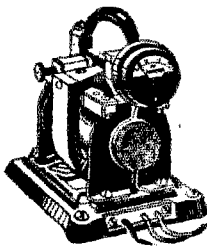

Is it not gratifying to feel that your filament battery will always be ready when you want it and that you will never have to give up in disgust when working a distant station?

F-F Battery Boosters are automatic and operate unattended. Screw plug in lamp socket, snap clips on battery terminals and see the gravity come up.

The ammeter shows you just the amount of current flowing. The full wave of current is rectified thru adjustable and easily renewable carbon electrodes which maintain a constant efficiency and last for thousands of hours. Everything complete on one compact, self-contained unit.

The F-F Booster is a Magnetic Rectifier for 105-125 Volt 60 Cycle Alternating Current. Bantam Type 6 charges 6 Volt Battery at 6 Amps. \$15 Type 16 charges 6 Volt Battery at 8 Amperes \$24 Type 166 charges 6 Volt Battery at 12 Amperes \$32 Also Boosters for 12 Volt Batteries at same prices Shipping weights 10, 12 and 15 lbs.

Order from your dealer or send check for prompt Express Shipment. If via Parcel Post have remittance include Postage and Insurance Charges. Will also Ship C. O. D. Also F-F Battery Boosters for charging batteries from Farm Lighting Plants, Direct Current Circuits and D.C. Generators. For Group Charging use the Full Wave Automatic F-F Rotary Rectifiers of 100 Volt, 36 cell capacity. Order now or write today for descriptive Bulletin No. 31 or Rotary 31A

The France Mfg. Co. Offices & Works CLEVELAND, OHIO

Canadian Representative: Battery Service & Sales Co. Hamilton, Ontario

SIMPLEX VARIOCOUPLER

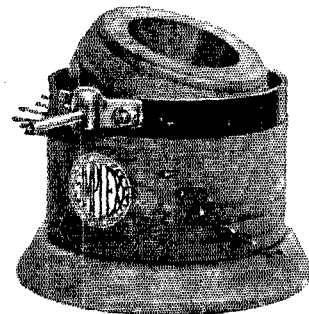

Price as illustrated \$6.00

Simplex Variometer \$6.00

This instrument is designed along the same lines as the Simplex Variometer. The Primary Tube is of black polished formica, 4 inches in diameter, the secondary ball and base is of thoroughly seasoned natural finished wood. The windings are of the same size wire as furnished on the Variometer No. 19 cotton covered, and the Primary is tapped in two groups, one of single turns and the other of seven turns each, making it possible to secure any combination up to 49 turns.

These taps are all tinned ready for soldering to leads. Bearings are similar in construction to those furnished on the Variometer having the same contact springs. Furnished with $\frac{1}{8}$ Shaft long enough for panel mounting.

The Simplex Variocoupler when used with two Simplex Variometers, makes a combination above the average Regenerative Set.

The Quaker Light Supply Co.
728 ARCH St., Philadelphia, Pa.
Attention: H. J. Dunbar.

A Super-Sensitive Crystal Detector

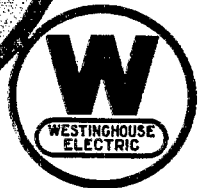
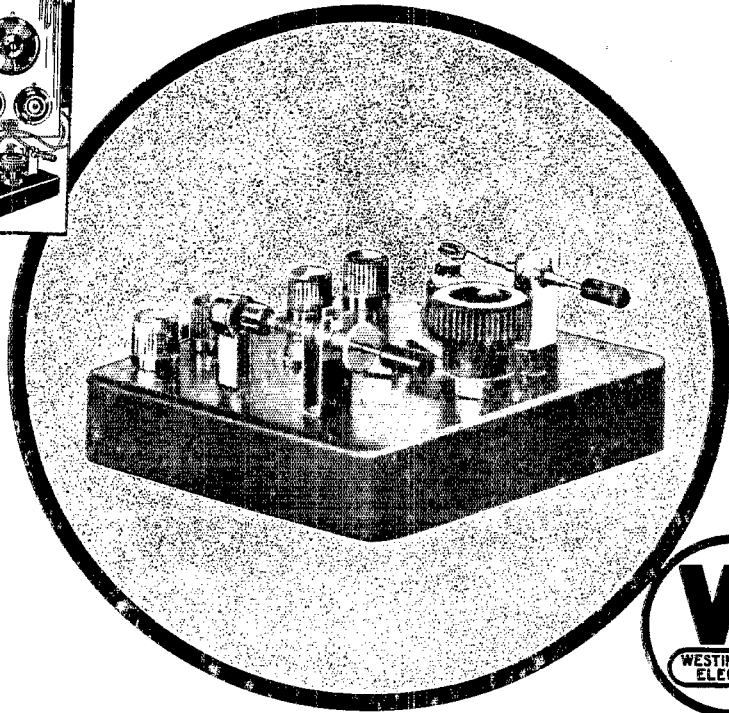
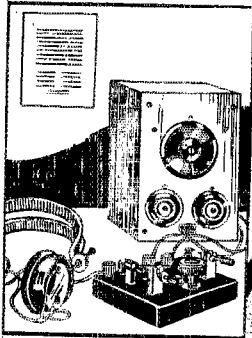

The new Westinghouse Type DB Crystal Detector.
Always ready for operation.
Does not require the use of a buzzer.
A throw-over switch connects in either of the two
crystals, one always being in reserve.

\$5.00

WESTINGHOUSE ELECTRIC & MANUFACTURING CO.
EAST PITTSBURGH, PA.

Westinghouse

ALWAYS MENTION Q S T WHEN WRITING TO ADVERTISERS



Clear as a Bell
**The New Bell Rotary
 Quenched Spark Gap**

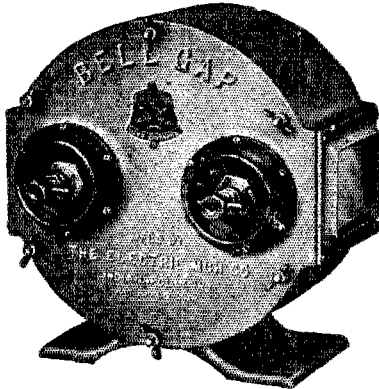

PRICE \$55.00

Place your order through your dealer

**THE NEW BELL ROTARY
 QUENCHED SPARK GAP**

RETAILS FOR \$55.00

More money cannot buy greater efficiency!

Less money cannot purchase equal quality!

Buy the Gap That Has No Upkeep

The Electric Machine Co.,

Indianapolis, Ind.

The original tested crystals



**NOW
 25c**

Be Sure of Results! Insist Upon Getting

N. A. A. TESTED CRYSTALS

These exquisitely sensitive minerals are the best that money can buy for radio detector and wave meter work. Each crystal is individually tested, wrapped in foil and packed in a convenient lithographed tin container. N. A. A. (Arlington) Tested minerals are the original tested crystals. To avoid their many imitation, look for the signature of J. S. NEWMAN on each box. Formerly 35c per crystal

At good Radio Dealers everywhere, or shipped direct post-paid on receipt of price.

**Now
 25c**

(Galena or Silicon)

THE NEWMAN-STERN CO.
 Newman-Stern Bldg., Cleveland, Ohio

**3000
 OHMS**



\$8

Post-Paid

"RED HEADS"

The Accepted Standard in Radio Receivers

At the new price of \$8.00 (formerly \$12.50) "Red Heads" are unquestionably the best wireless 'phone value in the world. Increased production, decreased costs and a sincere desire to promote lower prices prompt this remarkable saving.

SPECIFICATIONS: Aluminum back type with genuine bakelite ear caps, government type head band, extra fine 6 ft. cord with strain loops. Each receiver 1500 ohms (3000 ohms per pair). Sold on a money back guarantee basis and shipped repair anywhere on receipt of price. Dealers: Write for complete information.

THE NEWMAN-STERN CO.
 Newman-Stern Bldg., Cleveland, Ohio

Portable Set For Camping

Complete with 1000 ohm Murdock Phones, Head band, 100 feet of aerial wire and insulators. Price \$11.75 plus postage. Unequaled buy. Order quickly.

DREYFUSS SALES CORP.

179 Greenwich St., New York City

Do You Know

Doctor Mu?

A COLOSSAL EVENT

The new RASCO catalog just off the press is one of the greatest events in amateur radio. There are many radio catalogs, but the RASCO catalog is an event by itself for the simple reason that it

Contains 50 Vacuum Tube Hook-Ups

This is the one and only radio catalog containing such wonderful free information. Complete hook ups of all important vacuum tube circuits are given in clear diagrams with complete explanation. Just to name a few—The V.T. as a detector; detector and one-step amplifier; regenerative circuit; De Forest Ultraudion; V.T. to receive undamped and spark signals; Armstrong circuits; one step radio frequency amplifier and detector; three stage audio-frequency amplifier; short wave regenerative circuits; V.T. radio telephone; six-stage radio frequency amplifiers; radio and audio frequency amplifier; inductively coupled amplifier; Armstrong superheterodyne; radio frequency amplifier and crystal detector; C.W. transmitters; self-modulating 2 tube C.W. transmitter; V.T. transmitter with 6 volt battery; radiophone using plate and grid modulation; one tube radio transmitter and receiver, experimental radiophone; radiophone using Couplet oscillator circuit.

This list is only a partial one. You must positively see this wonderful book to appreciate it. It is made to fit the pocket—has heavy covers to withstand the wear and tear which it is sure to have at your hands because it will be your constant companion.

And, Oh yes! Before we forget it. If you are in need of the following remember "Rasco has it." These are only a few things contained in this catalog: Leags, Nuts, Dials, Knobs, Washers, Crystals, Litz Wire, Selenium, Cord Taps, Cap Nuts, Tin Foils, Name Plates, Spring Posts, Switch Parts, Metal Ribbon, Carbon Balls, Binding Posts, Switch Points, Switch Levers, Carbon Springs, Metal Springs, Contact Points, Low Melting Metal, Carbon Diaphragms, Screws, Copper Strip, "Spazchetti," Name Plates, Solders, Mica, Switches, Resistance Wire, Varicooper Rotors, Test Clips, Condenser Plates, Condensers, Antenna Connectors, Threaded Brass Rod, Ground Clamps, Etc., Etc.

The catalog contains 185 illustrations. On account of its great cost, this catalog cannot be distributed free of charge. It will only be mailed upon receipt of

15c in stamps.



185 Illustrations

The Rasco "Baby"

Here it is boys! The smallest and most efficient detector in the world—as well as the cheapest. Our illustration is full size, and while the various details can be seen at a glance, we feel so enthusiastic about it that we must tell you all of its good points. First, there is a solid hard rubber composition base, size 1 1/2" x 1 1/2". We have not forgotten two holes to screw down the detector.

Then we have the nickel holder and binding post combined which holds the sliding, knurled, hard rubber composition knob. As you see, this knob not only revolves in its holder, but can also be moved back and forward in order to explore each point of the detector crystal. Next we see the patent nickel detector cup and binding post combined. This is a little marvel all by itself and will not fail to evoke your admiration. No clamps, no soft metal to fuse with. You

THE RASCO "BABY"

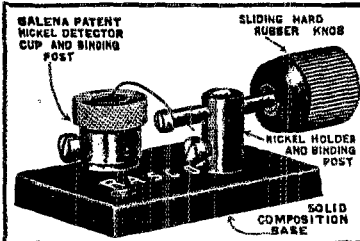

simply unscrew the knurled cap and insert your crystal into the stand, screw home the cap which leaves a goodly portion of the crystal exposed. The contact is perfect, while the crystal can be exchanged quickly in less than three seconds. By slightly unscrewing the cap, the crystal can be changed in position, in order to explore other sensitive spots. The cathinizer is of phosphor bronze and is attached to the horizontal bar by means of a slotted head screw. Can be readily exchanged in less than two seconds. Wires can be connected to the binding post in a jiffy. All metal parts are nickel plated, and you will be proud of this little masterpiece.

No. 1898 Rasco Baby Detector complete with green crystal, prepaid..... 50c

No. 1899. The same but furnished with an additional piece of tested radiocite crystal, prepaid..... 75c

Ready for distribution June 30th.

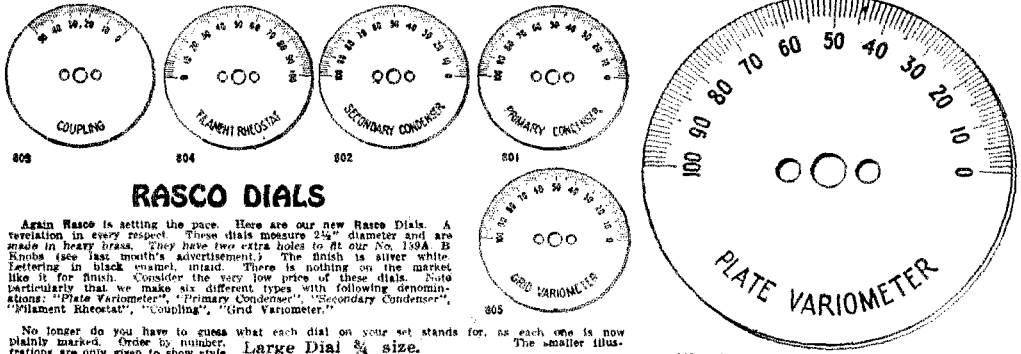

RASCO DIALS

Again Rasco is setting the pace. Here are our new Rasco Dials. A revelation in every respect. These dials measure 2 1/2" diameter and are made in heavy brass. They have two extra holes to fit our No. 1898 B Knobs (see last month's advertisement.) The finish is silver white lettering in black enamel, inside. There is nothing on the market like it for finish. Consider the very low price of these dials. Note particularly that we make six different types with following denominations: "Plate Variometer", "Primary Condenser", "Secondary Condenser", "Flameh Resistor", "Coupling", "Grid Variometer".

No longer do you have to guess what each dial on your set stands for, as each one is now plainly marked. Order by number. Large Dial 2 1/2" size. The smaller illustrations are only given to show style.

Prices all styles prepaid ea. 30c

A series of 6 dials complete prepaid, \$1.70

Do not compare these dials with some other makes as there is possibly no comparison between them. Must be seen to be appreciated. Money back if not satisfied.

800 Designs Copyright 1921 by R. E. Co.

Did you see our full page ad in the May issue? We expected a good deal of business, but we were amazed to show you! It shows that Rasco goods are wanted. In one week we filled over 100 orders and each and every order was shipped within 24 hours! Surely a record. We even filled orders for articles not listed. Our prices are low—our service is the quickest—and your small order is never side-tracked as all our orders are small. One trial order will make you a life customer. Try us with a 50c order. We can only "thank" you once!



DEALERS' GET OUR SPECIAL PROPOSITION.

Radio Specialty Co.

98-100 PARK PLACE, NEW YORK CITY

Factories: Brooklyn, N. Y.—Elkridge, Md.

WE GUARANTEE EVERY ORDER SHIPPED WITHIN 24 HOURS.

AMRAD

The Recognized Symbol of Superior Performance

Reduced Prices

Every article in the Amrad Line is guaranteed to meet advertised claims and deliver satisfaction. In reducing prices Amrad Quality has been maintained and even improved in some instances. Your nearest reliable dealer as listed on the back cover of this issue QST will fill your order promptly at the following prices established July 15th.

| | |
|---|---------|
| Crystal Receiver 180-750 meters..... | \$20.00 |
| Long Wave Tuner, 2000-20000 meters..... | 30.00 |
| VT Detector Control in Cabinet..... | 12.00 |
| VT 1 Stage Amplifier in cabinet..... | 17.50 |
| VT 2 Stage Amplifier in 10x5 Cabinet..... | 32.50 |
| VT Detector Amplifier..... | 27.50 |
| B Battery Box with Potentiometer..... | 8.50 |
| Variometer, short wave, in Cabinet..... | 11.00 |
| Variometer, short wave, unmounted..... | 6.75 |
| Variometer, medium wave, in Cabinet..... | 12.00 |
| Variometer, medium wave, unmounted..... | 7.75 |
| Coupler, short wave, in cabinet..... | 13.50 |
| Coupler, short wave, unmounted..... | 7.50 |
| Coupler, medium wave, in Cabinet..... | 14.50 |
| Coupler, medium wave, unmounted..... | 8.50 |
| Variable Condenser, .001 mfd. in Cabinet..... | 9.50 |
| Cabinet—Panel only, 5x5x6 1/4"..... | 2.25 |
| Cabinet—Panel, 10x5x6 1/4"..... | 4.00 |
| Cabinet only, 10x10x10" inside..... | 7.50 |
| Quenched Gap, 1 K.W. Type G-1..... | 30.00 |
| Adjustable Resistance for 1 K.W. Gap..... | 5.00 |
| Quenched Gap, 1/2 K.W. Type G-2..... | 17.50 |
| Adjustable Resistance for 1/2 K.W. Gap..... | 3.75 |
| Quenched Gap, 1/4 K.W. Type G-3..... | 10.00 |
| Adjustable Resistance for 1/4 K.W. Gap..... | 2.50 |
| Induction Coil, 6 volt or 32 volt..... | 17.50 |
| Wavemeter, 175-340 meters..... | 13.50 |
| Ampliformer, mounted..... | 4.50 |
| Ampliformer, unmounted..... | 3.75 |
| Filament Rheostat, porcelain..... | 1.00 |
| Tube Base, high insulation..... | .75 |
| Detector Stand, duplex type..... | 3.00 |
| Detector Stand, single type..... | 2.00 |
| Knob with Dial 180° or 90°..... | .65 |
| Dial only, 180° or 90°..... | .25 |
| Panel Switch accurately machined..... | .25 |
| Switch Points, fluted shank, per pair..... | .05 |

Improvements include new dark finish cabinets, smoother running controls and more rugged construction. Complete Price list or any descriptive bulletin desired sent free from nearest office; complete catalog 10c stamps.

AMERICAN RADIO AND RESEARCH CORPORATION

205 College Avenue, Medford Hillside, Mass.
13 Park Row, New York City
608 South Dearborn Street, Chicago, Ill.

100

ALWAYS MENTION QST WHEN WRITING TO ADVERTISERS

-A--A

AUDIO

FREQUENCY

Amplifying Transformers

HIGHEST QUALITY
MOST EFFICIENT

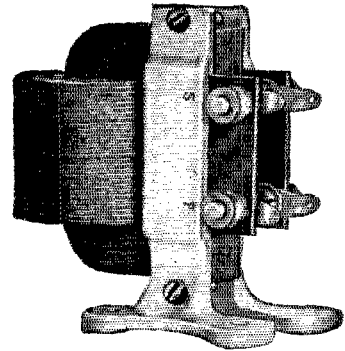

\$5.00

NOTE THE NEW (ONE PIECE)
PUNCHED LAMINATIONS

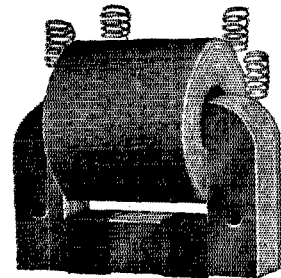

UNMOUNTED

\$4.00

SEMI-MOUNTED\$4.50

—DEALERS WANTED—

Shipments Made From Stock Prepaid.

Note Change of Address

All American Elecl. Mfrs.
1516 NORTH LOREL AVE.,
CHICAGO, ILL.

A WONDERFUL VALUE
MURDOCK No. 56
RADIO RECEIVERS

(Patented—Other Patents Pending)

Exceptionally
 well built.

Remarkable
 Durability.

Maximum of
 Sensitiveness

Uniformity
 in Tone.

Encased in
 Murdock-Moulded
 Insulation.

The last word
 in efficiency.

Unique in
 design.



2000 Ohms

\$5.00

3000 Ohms

\$6.00

MURDOCK VARIABLE CONDENSERS

We are producing in large quantities, tried and true variable air condensers. Our manufacturing processes and large volume production make possible the sale of these instruments at prices lower than any other condenser of equal merit and in some instances, at prices considerably below those asked for inferior instruments. The dependability and general goodness of the MURDOCK Variable Condensers is a matter of universal knowledge. Inquiry of those who have bought and used them will confirm our claim that they are the best buy in the market.

PRICES:

- No. 3660, panel type, 43 plates, .001 mfd, without knob, pointer or scale **\$4.00** each.
- No. 3661, panel type, 43 plates, .001 mfd, (with knob, extension handle, pointer and scale) **\$4.25** each.
- No. 3662, panel type, 43 plates, .001 mfd. (with special knob, extension handle and dial) **\$5.00** each.
- No. 3680, panel type, 23 plates, .0005 mfd. (without knob, pointer or scale), **\$3.25** each.
- No. 3681, panel type, 23 plates, .0005 mfd, with standing knob, scale and extension handle, **\$3.50** each.
- No. 3682, panel type, 23 plates, .0005 mfd. with special knob, dial and extension handle, **\$4.25** each.
- No. 366, Variable Condenser, 43 plates, .001 mfd. with case, **\$4.75** each.
- No. 367, complete condenser, 43 plates, .001 mfd, **\$4.50** each.
- No. 368, Variable Condenser, 23 plates, .0005 mfd. **\$4.00** each.

(Send for Bulletin No. 21)

Wm. J. Murdock Co.

65 CARTER ST., CHELSEA, 50, MASS.

509 Mission St.,

San Francisco, Cal.

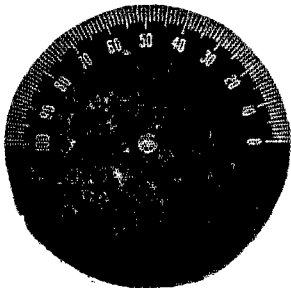

One Empire Dial FREE

With every \$2.00 order!

During the month of August, one regular stock Empire Dial will be included with every order for \$2.00 worth of apparatus. Don't miss this opportunity to get one of these serviceable dials for nothing!

Look over these August Specials carefully, ---save money

| | | | | | |
|--|--------|---|--------|------------------------------------|--------|
| Radio Service sockets | \$0.90 | Radiotron, detector. | 5.00 | JACKS AND PLUGS | |
| Turney short wave regenerative sets | 5.50 | Radiotron, amplifier, 6.50 | | Jack and Plug, complete | \$1.50 |
| Cabinets, high grade, hand polished to take 6"x9"x3/4" panel | 2.00 | V.T. CONTROL SETS | | Jack only | .85 |
| | | Remler | \$8.00 | Plug only | .75 |
| VACUUM TUBES | | Paragon | 6.00 | DIALS | |
| Audiotron, two filament | \$6.00 | Radisco new Vario-Coupler | \$7.00 | Chelsea, 3" dia-meter | \$1.00 |
| | | Radisco Variometer. | 6.50 | Empire, 2 1/4" dia-meter | .25 |
| | | Acme amplifying Transformers, mounted | \$5.00 | | |

EMPIRE RADIO EQUIPMENT CO., 271 W. 125 St., New York
Manufacturers and Distributors of Radio Apparatus.

THE SORSINC

"B" BATTERY

"The Largest B-Known"



22 1/2 Volt
 Size: 8" long
 4 7/8" wide
 5 1/8" high
 Cells: 4" x 1 1/2" diam.
 Rope Handle
 Moisture Proof
 Quiet

Capacity: 6400 Milliampere Hours.
 For Tube Transmission and Reception.
 Send Postal for Descriptive Folder.

Net 12 lbs. \$4.00 F. O. B. our U. S. Offices. Add P. P. Charge
 Packed 14 lbs.

Ship Owners Radio Service Inc.

New York
 Boston
 Philadelphia
 Baltimore
 Norfolk
 Savannah
 New Orleans

Galveston
 San Pedro
 San Francisco
 Portland, Ore.
 Seattle
 Honolulu
 London

Attractive proposition for dealers.

As The Sole Philadelphia

Distributors

for the

DE FOREST Radio Apparatus

we have in stock for immediate delivery practically every need in

Complete Radio Telephone Transmitting and Receiving Sets for the Amateur.

See the New Interpanel Sets
 Receiving 125 to 25000 meters

Free On Request Catalog E.

**CENTRAL ELECTRIC
 AND LOCK COMPANY**

1309 Arch St., Philadelphia

The Benwood Rotary Quenched "Sink" Gap

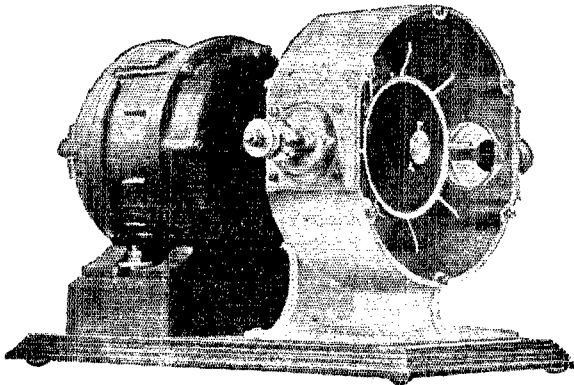

The finest synchronous spark gap made.

The lowest priced enclosed synchronous rotary quenched gap ever manufactured.

A REAL GAP AT A REAL PRICE.

The Outstanding features are:—

A REMOVABLE AND RENEWABLE POINT ROTOR

AN OIL-LESS BEARING (Graphite, no lubrication needed.)

CLEAR GLASS INSULATORS (Exclusive feature).

SILENT IN OPERATION (Aluminum or Bakelite housing).

A VISIBLE SPARK.

Furnished with a machined brass flexible coupling that makes slippage impossible. Gaps can be adjusted for synchronism at any time, but are properly set at factory before being shipped.

Complete mounted as shown with the **FINEST BALL BEARING 1800 RPM MOTOR.**

\$65.00 (Aluminum housing)

\$60.00 (Bakelite housing)

Synchronous motors are adaptable to any **BENWOOD GAP** now in use

Motors separate \$32.50

THE BENWOOD COMPANY, Inc.

1300 Olive Street,

St. Louis, Mo.

INDEPENDENT RADIO SUPPLY COMPANY

—ANNOUNCE—

A Complete Stock of Selected Radio Equipment.

3 Big Reasons Why You Will Benefit By Trading With Us:—

QUALITY—We have selected, for our line, only the best products of the leading Manufacturers.

SERVICE—We don't promise 24 hour service. No! We don't wait 24 hours!

ACCURACY—All items shipped exactly as you order them.

Our Catalog out in August. Get your name on our mailing list **NOW** and receive your copy **FREE**

INDEPENDENT RADIO SUPPLY COMPANY

"Better Results With Less Effort"

3716 W. Douglas Blvd.

Chicago, Ill.

Q S T

— G A N G —

WDNT U LIKE
TO HR SIGS

Q S A

ALL OVER
YR HOUSE

IT
IS BEING
DONE
WITH
THE

? \$45
AT YOUR
DEALERS

Radio Magnavox

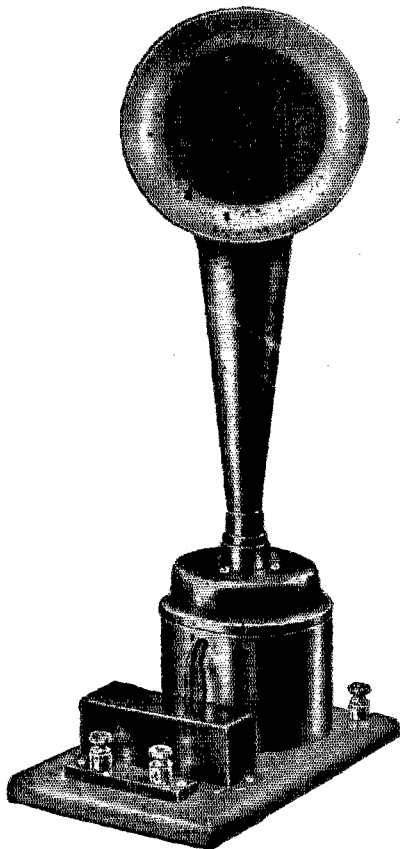

THE MAGNAVOX CO., Oakland, Calif.

NEW- THE FINEST DIAL ON THE MARKET

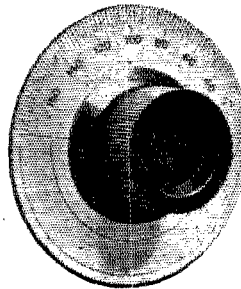

4" dia. 16 gauge Brass silver plated, and lacquered to prevent tarnishing. Clock wise Rotation. Two Calibration scales permit Rapid Adjustment. Polished Bakelite knob, 1 3/4" dia. and 2 1/4" at flange is just the right size. Has hole for 1/4" shaft and set screw.

SOMERVILLE DIAL INDICATOR.....\$2.00

SOMERVILLE FLANGED KNOB..... .90

Used for coupling or tickler control and also on Rheostats, where the Non-Melting feature is invaluable.

Anticapacity Contacts, 4c, 45c. per Dozen

Threaded shank and 1/4" Nut.

G-R Switch Stops 5c. each.

Insulated Binding Posts, Medium, 12c. each. 1 doz. \$1.25.

Large, 16c. each. 1 doz. \$1.65.

Empire Cloth Tubing, 10c. ft.

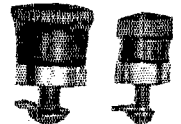

Northeastern Headquarters for Phone and C. W.

Accessories; Pioneers and still in the lead

1800V Grid Condenser .0005 MFD\$1.00.

\$2.25 Ward Leonard 5000 ohm Grid Leak \$1.88

PRICE REDUCTION

SORALA S10 VT SOCKETS—NOW—\$1.00 postpaid.

These have polished bakelite bases, polished aluminum shells, a new non-shorting feature, bronze contact springs and ample binding posts. Weight, 2 ozs. Built to Navy standards.

DURING AUGUST—

One of these sockets given free with each \$10 order.

NEW—NEW—NEW!

2000V test CW condensers, .001 or .002 mfd. 75c. Simplified design and a new development in a low cost dielectric, makes the low price possible.

General Radio 2 1/2 amp. 2 ohm rheostat...\$2.50

Shramco Reo, 6 amp. 1 1/2 ohm. for UV203...2.00

Fada rheostat (panel) 6 ohm. 1 1/2 amp....1.25

DeForest new type reversible rheostat.....1.65

DeForest Hand Microphone (with cord).....\$6.00

General Radio Modulation Transformer5.00

ANNOUNCEMENT

We are New England distributors for IDEAL

motor-generators, condensers, filters, and chokes.

We also carry a full stock of ACME CW transformers, filament heating transformers and chokes.

UV202 5 WATT \$8.00 Postpaid

RADIOTRONS UV203 50 WATT \$30.00 Postpaid

A NEW METER

TYPE JT RADIO FREQUENCY AMMETER \$12

Uses the same case (flush) as our famous Type

JX \$8 A.C. voltmeter, and is extremely accurate.

The Thermo-couple is contained within the case.

Type J Milliammeters 3 1/4" dia. flush. \$6.00

Ranges, 0-50, 0-100, 0-300, 0-500, 0-1500 m. a.

EACH METER GUARANTEED AND SENT POSTPAID

New Catalog and Treatise on Practical C. W. and

Phone Sets, Edition Limited, order now. 20c. postpaid

GREBE CR-5 RECEIVER..... 80.00

GREBE CR-3 RELAY TUNER..... 65.00

WESTINGHOUSE COMPLETE RECEIVER...125.00

WESTINGHOUSE TUNER..... 65.00

WESTINGHOUSE DETECTOR AMPLIFIER 65.00

SOMERVILLE RADIO LAB.

102 Heath Street, Winter Hill, 45, Mass.

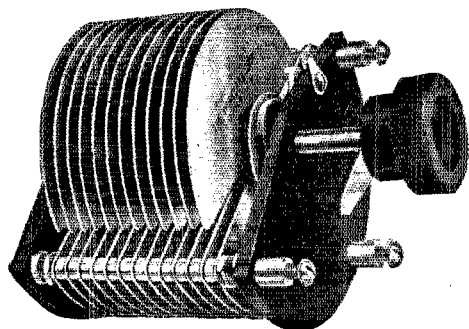

WANTED-- The Name of
Every Radio
Man Who Has
Had Trouble With His C.W.
Condenser.

*This One Won't Give
Trouble.*

**IF YOU ARE NOT ACQUAINTED
WITH "WIRELESS SHOP" CONDENSERS—LET'S SHAKE.**

We want every amateur who uses a variable condenser to know our product. Our new bulletin showing our entire line of variables will be mailed for the asking. Where shall we send your copy?

We build 14 different sizes of condensers, in three different types, and several special ones to order. The prices range from \$2.00 to \$10.00 for the standard instruments. Can any other manufacturer offer you anything like this in variables?

The NEW WIRELESS SHOP C.W. VARIABLE CONDENSER is designed to be used on CW sets where the plate voltage runs up to from 200 to 1000 or higher. You won't have makeshifts now. Get a condenser which is built especially for your C.W. set. The plates are widely spaced and the construction is rigid. Only the best of materials and workmanship throughout. Fully guaranteed to give satisfaction or your money back.

PRICES:

No. 1500 15 plate, approximately 0.0004 mfd. Max. capacity.. \$6.00

No. 2500 25 plate, approximately 0.0006 mfd. max. capacity.. 7.50

No. 3500 35 plate, approximately 0.0008 mfd. max. capacity.. 9.00

Regularly equipped with knob and pointer and mounting screws. A metal dial will be supplied instead of the pointer at 75c extra, or a high grade moulded bakelite knob and dial with graduations filled in white, will be furnished at \$1.00 extra.

Postal charges and insurance must accompany your remittance. Insurance on any CW condenser is only 5c. Isn't it worth it?



511 West Washington St.,

Los Angeles, Cal.

ANNOUNCING

THE SAYRE-LEVEL RADIO COMPANY

905 FILBERT STREET,

PHILADELPHIA, PA.

EVERYTHING IN RADIO

Do You Know

Doctor Mu?

AMATEURS!!!

Before buying your supplies get my prices on
KNOBS, BINDING POSTS, SWITCH POINTS,
CONDENSERS, AERIAL WIRE, INSULATED
CABLE, ETC. Send 4c for literature.

DEALERS:—Write for proposition

WILLIAM SCHICK

2723 Cooper Ave., Brooklyn, N. Y.

!!! ALL RECORDS BROKEN !!!

THE MASSACHUSETTS RADIO AND TELEGRAPH SCHOOL has broken all records for results during the past six months.

We have produced more First-Grade Commercial Operators during this period than any other school in New England. These men also obtained higher averages on their government examinations and were trained in a shorter period of time than students of other schools.

During the past eight months 16 graduates from the Evening School alone obtained First-Grade Licenses and averaged slightly over 80% out of a possible 90% with only six hours per week instruction. Their average attendance was six months and one week.

We produced more First-Grade Operators in any single month than were produced by any other school, 22 having successfully passed during the month of June. We believe this is a record for any school of the United States and invite comparison.

Formerly the Boston School of Telegraphy established in 1903, the home of Boston's first Wireless Station, when a complete DeForest Transmitter was installed at 18 Boylston Street, we are the oldest Wireless and Telegraph School in New England.

To produce the best results, we must be the best equipped.

Send for our new catalogue containing all the latest information desired by prospective wireless students—it is free. Your name and address will bring it.

G. R. Entwistle,
Director of Wireless.

We handle a full line of CW and Wireless Telephone Apparatus and Accessories. We would be pleased to advise you on your CW problems.

MASSACHUSETTS RADIO AND TELEGRAPH SCHOOL, INC.

18 Boylston St., Cor. Washington St., Boston, Mass.

Tel. Beach 7168. Call (1YS).

THE "ILLINOIS" VARIABLE CONDENSER

The Condenser with "Star Spring" Tension

MADE RIGHT - STAYS RIGHT

Hard Rolled Aluminum Plates

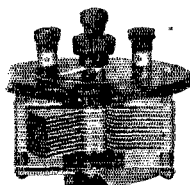
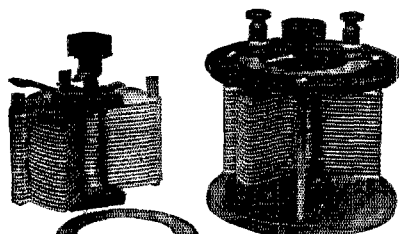

| | Style No. 1 | No. 2 | No. 3 |
|------------|-------------|--------|--------|
| 67 Plates, | \$7.00 | \$8.00 | \$8.50 |
| 43 Plates, | 3.50 | 4.50 | 4.75 |
| 23 Plates, | 2.75 | 3.75 | 4.00 |
| 13 Plates, | 2.25 | 3.25 | 3.50 |

Money back if not satisfied. Just return condenser within 10 days by insured Parcel Post.

VERNIER

Three Styles: No. 1. Panel; No. 2. Open Type as shown; No. 3. Fully Encased. Anti Profitteer. Less than pre-war prices. Fully assembled and tested. With Style No. 1, we will, if desired, furnish 3 inch metal Dial with large knob, instead of Scale and Pointer. Extra Price 75 cents. Or we will send Condenser with smooth $\frac{1}{4}$ " center staff, without Scale Knob and Pointer, at 15 cents off list, for those who prefer to furnish their own dial. Vernier with single movable plate applied to 18, 23, and 48, plate Condensers, \$3.00 extra.

Sent Prepaid on Receipt of Price.

Except: Pacific States, Alaska, Hawaii, Philippines and Canal Zone, add 10c. Canada add 25c.

G. F. JOHNSON, 625 Black Ave., Springfield, Ill.

MAIL ORDER LIST!

| | |
|--|--------|
| Clapp-Eastham Variometers..... | \$5.75 |
| Baldwin Variometers..... | 7.00 |
| Baldwin Variocouplers..... | 8.00 |
| Emco Variometers..... | 7.50 |
| Crystal Detectors, Ball Bearing..... | 1.75 |
| Variable Grid Leak $\frac{1}{2}$ to 3 Megohm | .75 |
| Murdo k 3000 Ohm Head Sets..... | 5.50 |
| Type F Baldwin Head Set Amplifier | 21.00 |
| Brandes Superior with new head band | 8.00 |
| 600 Meter, Slider Type Couplers.... | 6.00 |
| Small unmounted Phone Condensers | .35 |
| Grid Condensers..... | .35 |
| Combination with Leak..... | .50 |
| Portable Receiving Set for 600 meters, Is a Set complete without Phones for..... | 7.00 |
| CW Inductance with 3 Clips..... | 8.00 |
| Pancake Helix good up to $\frac{1}{2}$ K.W. | 2.50 |
| Series Parallel Switches..... | .35 |

The goods listed above is only a partial list. We carry all Radio Parts for the Amateur to make his own set, including Aerial Wire, 45c. lb.
Orders promptly shipped the day received.
10% DISCOUNT ALLOWED

AMERICAN ELECTRIC & WIRELESS SUPPLY CO.

Mail Order Dept. 335 B'way, New York
Tel. Franklin 1900

Best of Everything in
Radio Apparatus and Parts.

Send Stamp for Catalog "Q"

J. H. BUNNELL & CO.

32 Park Place,

New York

If it's a **RADIOPHONE**--It's a DeFOREST Invention

RADIOPHONE

REG. U.S. PAT. OFF.

Be Sure It's The DeForest Design of Wireless

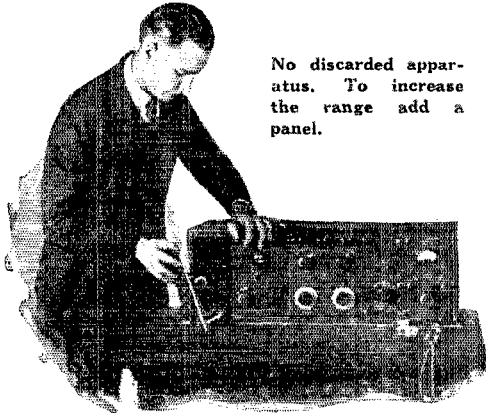

No discarded apparatus. To increase the range add a panel.

It is better to be sure first than sorry afterwards.

The DeForest "Interpanel" System is for amateur and commercial CW telegraph and telephone stations. It is the one design absolutely necessary to get full success of CW transmission, made possible by Dr. DeForest's invention of the audion.

Each panel is only 9 inches high. Each panel mounts a *complete* apparatus. Each panel gives the exact space best suited to all parts.

Panels may be combined in any relative positions.

FOUR PANEL STATION

Complete set of four units mounted vertically.

- (1) Complete radio "Midget" transmitter. Phone sending range 30 miles (OT-3)
- (2) Complete short wave tuner, 150 to 600 meters (MT-100)
- (3) Complete audion control, especially for gaseous tubes (MP-100)
- (4) Complete one-step amplifier (MP-200)
- (5) Any additional step of amplification may be added.

Get the "Interpanel Idea". Send for catalogue 89

DeForest Radio Tel. & Tel. Co., 1415 Sedgwick Ave., N. Y. City

Inventors, Licensers and Manufacturers of High Grade Radio Apparatus.

Sole Western Distributors:

Pacific Radio Supply Co.,

638 Mission St.,

San Francisco, Cal.

MAKE YOUR OWN REGENERATIVE SET From This COMBINATION

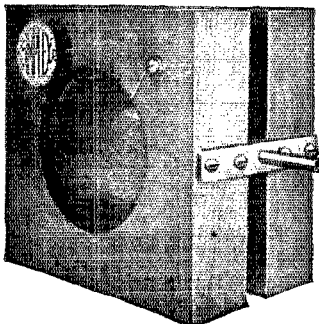

These instruments are wound with extra heavy wire to reduce the resistance, and have special long bearings with a spiral spring inserted to insure a perfect and self cleaning contact at all times. The taps on the Vario-Coupler are arranged in two groups.

PRICES PREPAID

Variometer as illustrated... \$6.00
Variometer mounted on formica panel & Dial complete 8.50
Vario-Coupler as illustrated 6.00
Vario-Coupler mounted on formica panel complete with two switches & Dial... \$10.00
Bulletin #10 sent on request.
Dealers furnished with trade discounts.

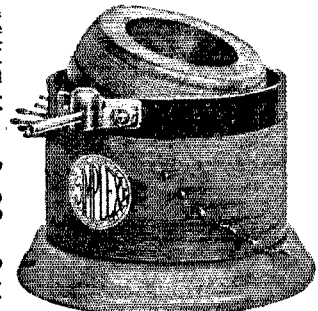

Simplex Radio Co. 1013-15 Ridge Ave. Phila. Pa.

Quality Radio Equipment

Ideal Vacation Outfit

New Grebe Portable
Radio Station Type KT-1

**Especially Adaptable and Efficient for Boy Scouts,
Campers and Tourists.**

Absolutely the newest and neatest combination
Transmitting and Receiving Portable Outfit on the
market. Complete with Grebe CR-5 Receiver,
Transmitter, Vacuum Tubes, Batteries and Head
Set in attractive and durable case. Weight 24 lbs.

\$175.00 COMPLETE

Full line of Radiotron Vacuum Tubes and Accessories, and other Highest Grade
Radio Supplies

Dealer's Special Proposition—Mail orders promptly filled.

DOUBLEDAY-HILL ELECTRIC CO.

715 12th St., N. W., Washington, D. C. Radio Dept.—Desk A 719-21 Liberty Ave., Pittsburgh, Pa.

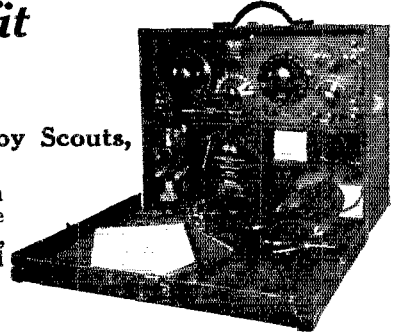

Our Tuners and Condensers

Brought in the Big-Fight Results in
Great Shape. They Made a Record.

C. W. CONDENSERS

Good for use up to 2000 volts. Now
ready for distribution. 24-page new
catalog now ready, brim-full—Hook-
ups and New Equipment. 10c brings
it to you.

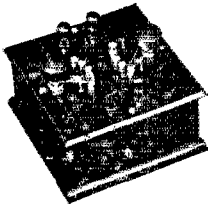

TUNERS

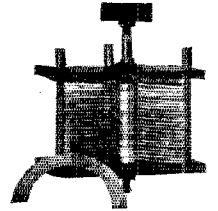

CONDENSERS

TRESCO

Davenport, Iowa

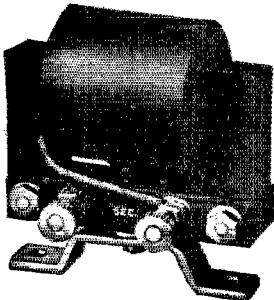

Rhamstine★ Radio Products

Audio Frequency
**AMPLIFYING
TRANSFORMER**

Mounted \$3.50
Postage & packing 10c

Made of the very
best materials,—lam-
inated core of sili-
con steel, bakelite
binding post sup-

ports, ratio of primary and secondary correctly
proportioned for the new tubes. The one-
piece base is swivel mounted. All brass parts
nickle plated and polished. Circular com-
pletely describing the transformer upon re-
quest.

Guaranteed Satisfaction.
Order yours today!

J. THOS. RHAMSTINE★

2152 Larned St., E.

Detroit, Mich.

Dealers write for discount

*Amplifying Transformers—Plugs and Jacks.

ATTENTION—ADVANCED AMATEURS

Introductory Offer of the

BRONX RADIO EQUIPMENT COMPANY

687 Courtlandt Ave., Bronx, New York

Combination Long and Short wave set. Size of
panel, 15" x 15". Range 150 to 20,000 meters.
Price \$125.

Real Telephone set. Four tubes. Range 50 to
250 miles. Panel 12" x 15". Price \$130.

Telephone panel 1 Tube. Range 50 miles. Panel
8" x 10". Price \$50.

Two step amplifiers. Size 7" x 8".
Built with:—Federal transformers, plugs and jacks,
Paragon rheostats and XX Bakelite. Price \$45.
Special—6 Volt—60 Ampere Storage Batteries
Price \$12.35.

Rectifier panel—500 Volt D.C.—Size of panel 15x12.
Price \$130.00.

Combination detector and two step and short
wave regenerative set. Special price \$100.00. Panel
size 17½x22.

Short wave regenerative sets. Panel size 6½x16.
Limited number of Audiotron Bulbs and Adapters
at \$5.00

ESTIMATES FURNISHED ON RECEIVING,
TRANSMITTING AND PHONE SETS BUILT TO
YOUR OWN IDEA AND SPECIFICATION.

FULL LINE OF ALL STANDARD MAKES OF
RADIO APPARATUS

Calling From The "Vasty Deep"

"Glen—I can call SPIRITS from the vasty deep.
 Hat—Why, so can I, or so can any man;
 But will they come when you do call them?"

King Henry IV.

From the wireless outfits on the ships that sail the seas and from the far places of the earth Brandes Receivers call the Spirits of Sound—and they COME!

The signals so weak and encountering such strong interference, that other receivers fail to get them, come "clear as a bell" through the Brandes Matched-Tone Headsets—the wonders of the wireless world.

"Superior" Type Headset Price \$8.00
 "Navy" Type Headset Price \$14.00

Sold on 10 days' trial. Money refunded if not satisfactory.
 Send 5c for Catalog F.

DEALERS—Write for Special Proposition.

C. BRANDES, INC.

Room 821, 32 Union Square, New York City

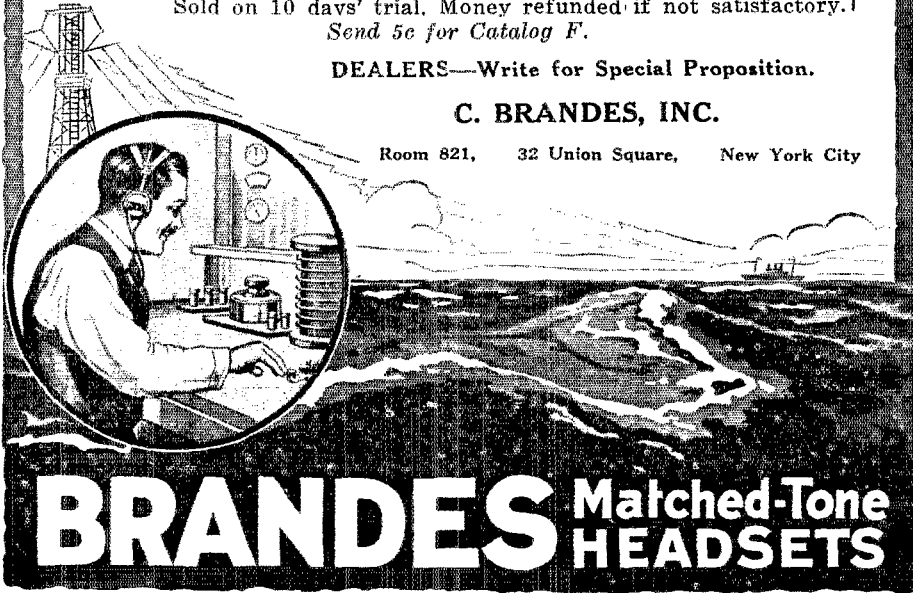

BRANDES Matched-Tone HEADSETS

MINNESOTA RADIO AMATEURS

AND OUR NEIGHBORS

We have a complete line of radio apparatus and represent over thirty radio manufacturers. Write us for prices.

POSTAGE PAID

Duluth's Oldest Electrical Store

BURGESS ELECTRIC CO.

310 W. FIRST ST., DULUTH, MINN.

RADIO SUPPLIES 4TH DISTRICT

We have a complete line of Radio Apparatus of standard makes. Acme, Amrad, Chelsea, Clapp-Eastham, Eveready, Federal, General Radio, Muddock, and Radio Corporation of America.

FORMICA PANELS

| | |
|-------------------|--------|
| 6 x 12 x 1/8 in. | \$1.35 |
| 6 x 18 x 1/8 in. | 2.00 |
| 9 x 12 x 1/8 in. | 2.00 |
| 12 x 18 x 1/8 in. | 3.85 |

RADIOTRON TUBES

| | |
|--------------------------------|--------|
| UV-200 Detector | \$5.00 |
| UV-201 Amplifier | 6.50 |
| UV-202 5-Watt Transmitting | 8.00 |
| UV-203 50-Watt Transmitting | 30.00 |
| UV-712 Amplifying Transformer | 7.00 |
| PR-536 A Bat. Potentiometer | 2.00 |
| 677 B Battery 22 1/2 V. 5 Taps | 3.00 |

Write for complete price list of material carried in stock.

CARTER ELECTRIC CO.

63 Peachtree St., RADIO DEPT. Atlanta, Ga.

Chelsea Variable Condensers (Die Cast Type)

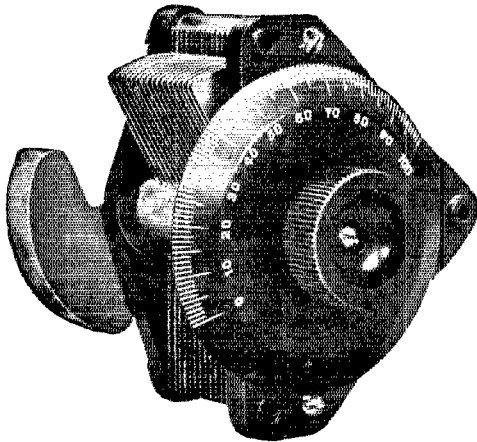

| No. | Capacity | Type | Size | Weight | Price |
|-----|-----------|--------------|-----------------------|------------|--------|
| 1 | .0011m.f. | Mounted | 4 1/4 x 4 1/2 x 3 1/4 | 1 3/4 lbs. | \$5.00 |
| 2 | .0006m.f. | Mounted | 4 1/4 x 4 1/2 x 2 3/4 | 1 1/4 lbs. | 4.50 |
| 3 | .0011m.f. | With Dial | 4 1/4 x 3 x 4 | 2 lbs. | 4.75 |
| 3 | .0011m.f. | Without Dial | 4 1/4 x 3 x 4 | 2 lbs. | 4.35 |
| 4 | .0006m.f. | With Dial | 4 1/4 x 3 x 3 1/2 | 1 1/4 lbs. | 4.25 |
| 4 | .0006m.f. | Without Dial | 4 1/4 x 3 x 3 1/2 | 1 1/4 lbs. | 3.85 |

Top, bottom and knob are genuine bakelite, shaft of steel running in bronze bearings, adjustable tension on movable plates, large bakelite dial reading in hundredths, high capacity, amply separated and accurately spaced plates.

Unmounted types will fit any panel and are equipped with counter-weight.

Purchase from your dealer; if he does not carry it, send to us. Bulletin sent upon request.

Chelsea Radio Co., 15 Fifth St., Chelsea, Mass.

Manufacturers of Radio Apparatus and Moulders of Bakelite.

RTS

* AMATEURS *

RTS

MANUFACTURERS—DEALERS & JOBBERS

We are the originators of the RTS Condensers. We do not hesitate to say that our Condensers will surpass all other makes, regardless of price.

SIMPLICITY IS THE SECRET OF THEIR SUCCESS COMBINED WITH THE BEST GRADE MATERIALS OBTAINABLE.

IF YOU HAVE NOT PURCHASED YOUR CONDENSERS

DO IT AT ONCE

| | | |
|--|------|--------|
| RTS—GRID CONDENSER, .0005 M.F. | Each | \$0.35 |
| RTS—GRID CONDENSER AND GRID LEAK .0005 MF. | Each | .50 |
| RTS—FIXED PHONE CONDENSER .0013 M.F. | Each | .40 |
| —NOW READY— | | |
| RTS—CONDENSER FOR RADIOTRON TUBES. | Each | .40 |

SEND FOR CATALOGUE

RADIO TESTING STATION,

BINGHAMTON 25, N. Y.

Canadian Radio Experimenters --- Special Radio Storage Batteries

| | |
|------------------------------|---------|
| 40 Ampere hours | \$22.00 |
| 60 Ampere hour | 25.00 |
| Baldwin Telephones Type C | 24.75 |
| Brandes Telephones Superior | 12.00 |
| Transatlantic Telephones | 18.00 |
| Navy Telephones | 21.00 |
| Murdocks Telephones 2000 ohm | 6.00 |
| “ “ 3000 ohm | 7.20 |

Lateral Coils to order
Inductances for Wireless Telephone
Milliammeter and Hot Wire Meters
Vario-Couplers & Variometers... \$4.25
Transmitters for Radio purposes... 3.50

LOOK! LOOK!! LOOK!!!

| | |
|--|---------|
| 1/4 H.P. 110 Volt 25 cycle Menominee Motors | \$30.00 |
| 1/5 H.P. 110 volt 25 cycle Menominee Motors | 25.00 |
| 1/10 H.P. 110 volt 25 cycle Menominee Motors | 20.00 |

Send 5c for 30 page catalogue

J. M. PAQUIN

The Electrical Shop, 787 Queen St., W. Toronto, Ont.

“Praco Cabinets Lead Again”

We have especially designed a Praco Cabinet for the new Remler Detector Panel.

QUALITY—The same high-grade materials and workmanship characteristic in all Praco apparatus.

FINISH—Same as our standard Cabinets, stained, filled, shellacked, varnished two coats, hand rubbed.

WOOD—Genuine African Mahogany, 3/8 inch thick.
SIZE—The exact size for a Remler Detector Panel—just slide panel into Cabinet.

PRICE—Within the reach of all—\$4.00 postpaid.

We would like you to see this little cabinet, may we send you one today? Don't send any money; just pay the postman when it arrives. Your money back if not delighted.

We carry the Remler Detector Panel in stock, and will be glad to mount same in one of our Cabinets free of charge, and send you the complete outfit, postpaid for \$12.00.

If you don't have one of our Cabinet catalogs—write us.



**Penn Radio Apparatus
Company, Inc.**

Dept. RC2. Reading, Pa.

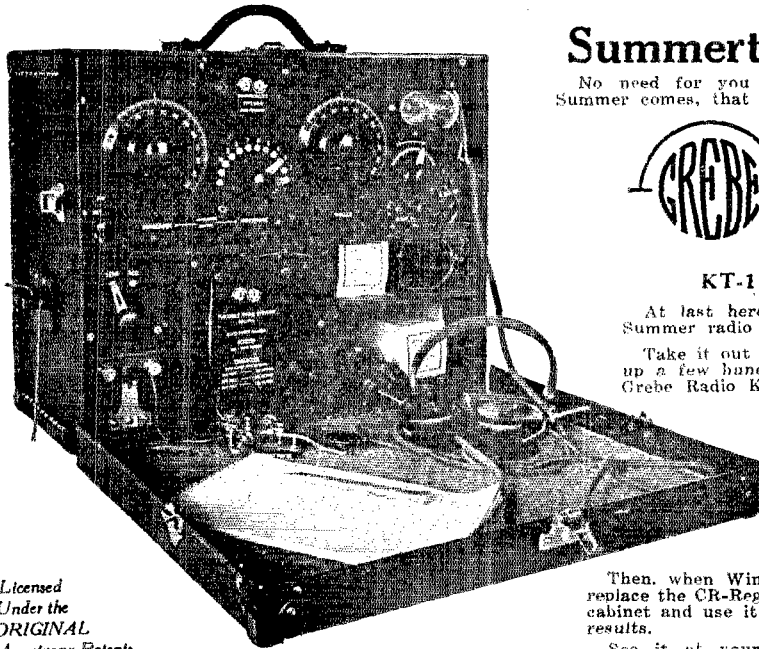

Licensed
Under the
ORIGINAL
Armstrong Patents.

Summertime Radio

No need for you to shut up shop when Summer comes, that is, if you own a



KT-1 Portable

At last here's the outfit that makes Summer radio work a pleasure.

Take it out into the country and send up a few hundred feet of antenna on a Grebe Radio Kite, and surprise yourself at its range.

Find out the range of your home station.

If you live near a body of water, procure a canoe or row boat and you have a ship station that sails under power of your kite.

Then, when Winter comes again, merely replace the CR-Regenerative Receiver in its cabinet and use it in your station for real results.

See it at your Dealer's today!

A. H. GREBE & CO., INC., 74 Van Wyck Blvd., Richmond Hill, N. Y.

A SMASHING HIT!

The Crosley V-T Socket 60c

"BETTER—COSTS LESS"

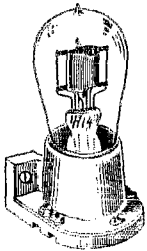

This Socket is made of porcelain—the ideal material for the purpose. Our own special design makes possible the use of this material. Has many advantages over other types of sockets, in addition to moderate price. Suitable for either panel or base mounting. If your dealer does not handle them, order direct and send us his name.

Watch for our announcement of new \$1.00 Variable Condenser. We are also manufacturers of cabinets, CROSLY MAG-FON, and other radio apparatus. Write for circular matter.

DEALERS: *it will pay you to handle our line. Write for full particulars.*

Crosley Manufacturing Co.
Dept. Q.S.T. #2, Cincinnati, Ohio

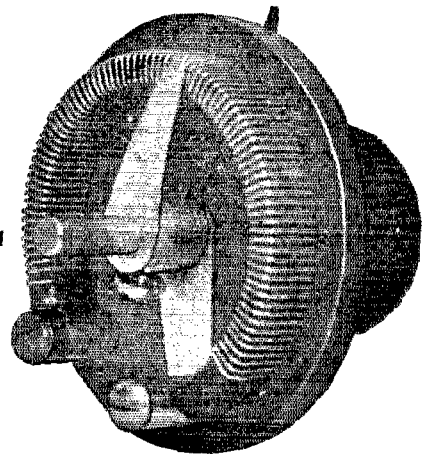

FADA RHEOSTAT

The very best panel-mounting rheostat you can obtain from your radio dealer or postpaid for

\$1.25 each

F. A. D. ANDREA

Manufacturer of FADA Radio Products
1882-B Jerome Ave., New York City

Do You Know

Doctor Mu?

A. R. R. L. MEN!

150 TO 25,000 METER REGENERATIVE RECEIVER IS
HERE—THE "REGENIFIER"

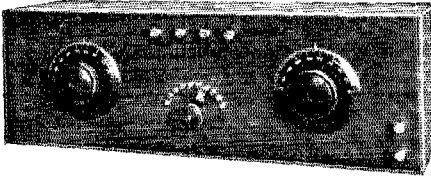

The most remarkable, as well as welcome, piece of radio apparatus has been developed! No longer is it necessary to change wires and connections or plug in numerous coils, to get all the stations. The Regenifier is the latest innovator of the popular regenerative circuit and applies this unapproachable circuit to a wavelength range covering every wavelength used, without the sacrifice of sensitivity or efficiency on any of the wavelengths covered. It is a marvel for C.W. reception.

THE REGENIFIER THREE MODELS

- 150 to 475 meter Regenifier Only \$48
 - 150 to 4000 meter Regenifier Only \$68
 - 150 to 25,000 meter Regenifier Only \$98
- DEALERS WRITE.

In operation it is the last word in simplicity. Has only three controls each being variable over entire wavelength scale, there being no change-over from short to long waves. Its super positive control of oscillations and amplification together with its remarkable flexibility of operation has destined it to become the property of every exacting radioman. Encased in genuine Oak Cabinet 7x7x21 inches; panel Bakelite, four inch dials used, all metal parts highly nickelled.

No matter what model you buy, for any wavelengths you desire, the Regenifier will prove superior to any other receiver of similar nature. This instrument guaranteed for two years. Order YOUR Regenifier at once.

Send For Circular

Glenhurst Research Laboratories, Omaha

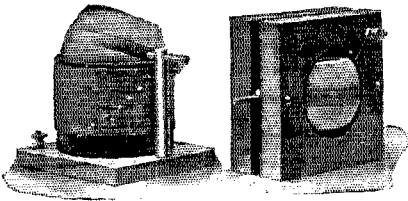

Variometers
Couplers **\$3.75**
EACH

These instruments embody finest workmanship and best materials, all wooden parts genuine mahogany, coupler primary wound on formica tubing. Metal parts of brass. Wound for maximum results on short wave work. Money back if they fail. With Chelsea Dial \$1 Extra. Send for bulletin describing unwired regenerators.

FREDERICK WINKLER, Jr.
304 COLUMBUS AVENUE
New York City, N. Y.

A Full Line of Radio Apparatus

We have everything you need. Below are a few items from our large stock. Watch this space for a complete stock list.

POWER TUBES

- A-P 5 watt..... \$7.50
- Cunningham C302 5 watt..... 8.00
- Cunningham C303 50 watt..... 30.00
- Cunningham C304 250 watt..... 110.00
- DeForest Singer Type 37 watt.... 24.00
- DeForest Oscillion 250 watt..... 60.00
- DeForest Oscillion 500 watt..... 75.00
- DeForest Oscillion 1000 watt.... 150.00

We have all the necessary material for CW outfits.

- 350 volt generators..... \$20.00
- 6" diam. 1/8" wall Formica Tubing
Per ft. 2.75

Send for bargain list.

The above prices are F.O.B. St. Paul.

PIONEER ELECTRIC CO.

137 East Fifth St., St. Paul, Minn.

"PENN C" VARIABLE GRID LEAK FOR "CW" SETS

Any resistance up to 10,000 Ohms. Special Large Graphite Sector, Nickel Switch Arm, and Hard Rubber Knob. Complete for Panel Mounting \$2.50. Sector only \$1.25.
Everything in wireless. Complete line of "CW". Specialists on rectified A.C.

"Service is a hobby with us"

PENNSYLVANIA WIRELESS MFG. CO.

507 Florence Ave.,

New Castle, Penna.

The McTighe Storage "B" Battery

Patents Pending.

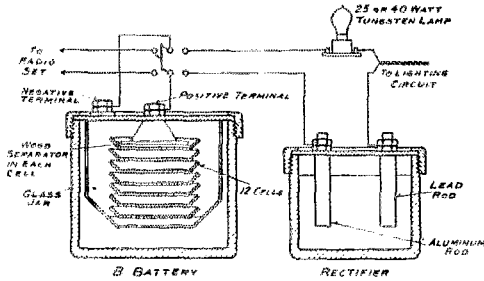

The McTighe storage "B" battery is the most satisfactory source of plate voltage for radio receiving apparatus. It is absolutely noiseless and eliminates troubles often attributed to static but which are really due to defective "B" batteries. It consists of twelve cells of the lead-acid type, giving 24 volts, in one unit. The capacity is 10 milliamperes for 8 hours, or 50 milliamperes for one hour. It will furnish 300 milli-amperes for a short time, which makes its use possible for C. W. and radio-phone transmission. The tone produced is exceptionally clear.

It will hold a charge for several days and when run down it is only necessary to throw the switch to the charging side for few hours. The charging current is from 25 to 50 milliamperes, thus cost of charging is negligible.

The assembled battery is shipped ready for use, except that the small quantity of electrolyte must be added to each cell either with a medicine dropper, or by dipping the whole battery unit into a vessel of electrolyte. The electrolyte can be obtained at a garage or battery service station. After the first filling the battery needs only a few drops of distilled water in each cell every week or two.

The chemical rectifier operates on the well known principle of lead and aluminum rod in a solution of baking soda or borax.

The battery set of parts can be easily and quickly assembled by following the instructions, and only about 48 hours of electrical forming are required.

PRICES:

| | |
|--------------------------------|--------|
| BATTERY COMPLETE | \$5.00 |
| RECTIFIER | 2.00 |
| SET OF PARTS FOR BATTERY | 3.50 |

McTIGHE BATTERY CO., Wilkinsburg, Pa.

ACE

*Efficient
Equipment
at a
Reasonable
Price*

ACE Radio Apparatus will give your station that clean-cut, dignified and business-like appearance so characteristic of the modern Radio Amateur's Installation. We offer below several suggestions:

| | |
|---|---------|
| Ace Type AVA Variometer Tuner .. | \$32.00 |
| Ace Type AVB Variometer Tuner .. | 45.00 |
| Ace Type ATC Audion Control Cabinet | 12.00 |
| Ace Type A-2 Two Step Amplifier Cabinet | 40.00 |

We also carry in stock a complete line of high grade, reliable radio accessories.

Send 3 cent stamp for Bulletin No. 102.

Mail orders will receive our prompt attention.

SEE OUR DISPLAY AT THE A. R. R. L. NATIONAL CONVENTION, AT CHICAGO, AUGUST 30th to SEPTEMBER 3rd.

The Precision Equipment Co., Inc.
2437-2439 Gilbert Ave. Cincinnati, O.

"You May Pay More But You Can't Buy Better"

Member A. R. R. L. Radio Call 8 X B

KEYSTONE WIRE

Wire for every Wireless Purpose

MAGNET WIRE

We are prepared to furnish best grade magnet wire on $\frac{1}{8}$ and $\frac{1}{2}$ lb. spools at the following prices:

| Size B & S Ga. | PRICE PER $\frac{1}{2}$ LB. SPOOL | | | |
|-------------------|-----------------------------------|---------------|----------------------|----------------------|
| | Single Cotton | Double Cotton | Single Silk Enameled | Double Silk Enameled |
| No. 22 | \$0.56 | \$0.68 | \$0.62 | \$0.45 |
| No. 24 | .60 | .77 | .67 | .47 |
| No. 26 | .60 | .88 | .71 | .49 |
| No. 28 | .75 | 1.10 | .85 | .52 |
| No. 30 | .85 | 1.24 | .97 | .53 |
| No. 32 | | | 1.15 | .55 |
| No. 34 | | | 1.52 | .59 |
| No. 36 | | | 1.77 | .69 |

Price of $\frac{1}{2}$ lb. spools double above list.

All prices are net and include cost of spool and delivery charges via Parcel Post to any Post Office address in the United States; safe delivery guaranteed.

Send for Circular 21-A giving prices on other sizes, insulations and quantities of Magnet Wire. This circular lists "WIRE FOR EVERY WIRELESS PURPOSE."

KEYSTONE WIRE COMPANY

P.O. BOX 120 SCRANTON, PA.





It's a matter of pride with us to keep up our record of good service.

Our service means that every order and inquiry receives the same prompt, careful and courteous attention that is given to customers who deal with us over the counter.—satisfaction guaranteed.

A trial will convince you.

*Anything and everything
in radio advertised
in this magazine.*

Radio Department

Kelly & Phillips

312 Flatbush Ave. Brooklyn, N. Y.

NEW ORLEANS RADIO

APPARATUS AND SUPPLIES

ROSE RADIO SUPPLY

604 GRAVIER STREET

NEW OLEANS, LA.

Send 10c for Latest Catalogue

ACME Amplifying Transformer

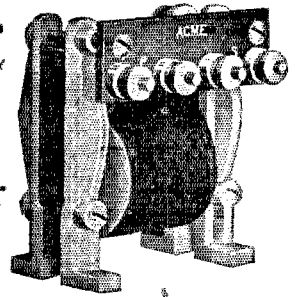

THE PROPER ratio of turns and impedance, exactly suited to the new VT's is an important feature of the transformer shown above.

Our coils are of the paper wound type, thoroughly impregnated. They are provided with strong flexible leads, and contain no solder or flux of any description. Get an ACME amplifying Transformer and your transformer needs are cared for perpetually!

Electrically, mechanically, and artistically,— from every viewpoint an Acme is as good a transformer as can be made. And every instrument is backed by the ACME guarantee.

ACME APPARATUS CO.

194 Massachusetts Ave.

Cambridge, 39, Mass.

Transformer and radio engineers and manufacturers

1/4 H. P., 110 volts,
A. C., 60 cycle,
single phase,
1750 R. P. M.

MOTORS

LARGE QUANTITIES NEW WASHING MACHINE MOTORS

These are of standard manufacture and carry the full factory guarantee. Shipped in original boxes. Complete as set. Suitable for operating Coffee Grinders, Cream Separators, Bottle Washers, Air Compressors, Small Lathes, Etc.

\$22.75

Each \$22.00 each or money order. We will send C.O.D. subject to full examination. Money Back Guarantee.

Separate Small Motors and Condensers Write for Catalogue Special Quantity Prices-Value \$12.50

MANUFACTURER'S DISTRIBUTOR
CHAS. H. JOHNSTON - Box 14 W. E., Pittsburgh, Pa.



BUZZERS

for all radio work. External tone adjustments. Satisfaction guaranteed "RADIO'S BEST BUY"

60c POSTPAID 60c

AJAX ELECTRIC CO.

Palmer St.,

Cambridge 38 Mass.

A C.W. and Radio Phone Chemical Rectifier guaranteed for use with Acme or similar transformers. Suitable for two five Watt tubes. Set consists of ten jars, plates, chemicals and full directions for use. Introductory Price Only \$6.00

EDWARDS-NOBLE COMPANY

441 North Broadway,

Yonkers, N. Y.

**Complete New Line
of**

**Jewell
Instruments
FOR C.W.**

Available as voltmeters, ammeters or milliammeters for direct current, alternating current and high frequency current, the latter being of the thermo-couple type.

Case diameter, 3". Flange diameter, 3 3/4" The logical radiation ammeter for C.W. sets, combining accuracy, durability and of good appearance.

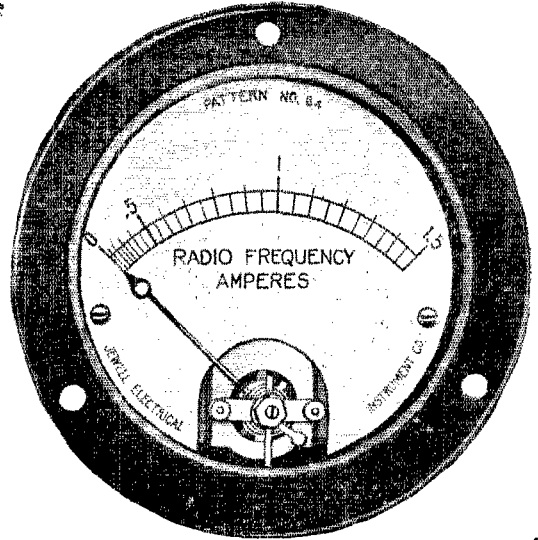

**SOLD BY ALL RADIO DEALERS
JEWELL ELECTRICAL INSTRUMENT CO.
1640-50 WALNUT ST., CHICAGO**

**A Brand New Storage Battery.
More Capacity for Less Money**

A battery with twice as many plates per cell as the standard battery. The most powerful and longest life battery ever built. Guaranteed 2 years.

Price, F.O.B. Cleveland:—
6 Volt 80 Ampere hour.....\$28.00
8 Volt 80 Ampere hour..... 36.00

Colebrook - Hamilton Battery Co.
1940 E 82nd. 1941 E 81st
CLEVELAND, OHIO.

THE BARRIETTE RADIO SHOP

Amateur Stations installed. Instructions given to Amateurs Free of Charge Saturday Evening 7 to 8 p. m.

Receiving Sets Built to Order.

Come in and look around.

473 Sumner Ave., Brooklyn, N. Y.
Near Fulton St. Decatur 7660

QST de 8AFO all NRH and Vicinity

We sell Radiotrons, DeForest, Acme Apparatus, Burgess B Batteries, Brandes and Baldwin Fones, Eldridge meters, Remier, Tuska, Clapp-Eastham, Magnavox, Genuine Willard 6-80 batteries \$30.00. Consult us before you buy. Ask for information and latest bulletins.

KRAUS BATTERY CO.
3425 W. 25. CLEVELAND, O.

RADIO CONSTRUCTION CO.

Manufacturers of all kinds of Wireless Telephone and Telegraph apparatus. Panel drilling and engraving a specialty. Binding Posts, stops, switch points, nuts and screws of all sizes.

42 Maverick Square
Winthrop Block East Boston, Mass.

CANADIAN AMATEURS

Deal in Canada and Save \$\$\$\$

The Leading Amateur Supply House for
WIRELESS
Apparatus and Parts.

Send 5 cents for our list.

THE VIMY SUPPLY CO.

567 COLLEGE ST., TORONTO

WANTED!

Entrants for the Second Transatlantic Tests
in November.

WRITE THE TRAFFIC MANAGER

CLASSIFIED ADVERTISEMENTS

Five cents per word per insertion, in advance. Name and address must be counted. Copy must be received by the 10th of month for succeeding month's issue.

FOR SALE: All of my apparatus both Spark and CW cheap, write for list. Walter Taylor, 9CA, Minonk, Illinois.

EDISON B Battery elements. Make your own. Can be recharged and lasts for years. Harry Morrell, 52 Goffe St., New Haven, Conn.

FOR SALE: Any back nos. Q S T, some Experimenter, Radio News. Step-down transformer for spark coils \$2.50. Two new Clapp-Eastham Variometers each \$3.50. Barrett, 3150 Central Ave., Indianapolis.

AUTO MOTORS SUPPLIES: Buick—Michigan—Stoddard-Dayton—E. M. F.—Cadillac—Overland—Continental and Buda Motors. All types, \$50.00 each and up. New Dixie Magnetos \$20.00. Splittorf High Tension Magnetos \$10.00. Kellogg Pumps \$3.50. Auto-Lite generators, new \$10.00. Air gauges \$0.65. Remy Ignition Coils, new \$3.00. Electric and gas headlamps, coils, distributor heads, air compressors, etc. Write for catalog. Motor Sales Dept. 19, West End, Pittsburgh, Pa.

SELL: Heavy duty rotary gap induction motor, 1-3 H.P., speed 1800, for \$20. Drives SJE's big Hyrad disc at 5000 RPM with belt. Quick start and stop. Ideal for big disc with few teeth. Edward C. Jones, Jr., Fairmont, W. Va.

FOR SALE: Half K. W. Acme never used \$18.00. Murdock 17 and 43 plate condenser \$2.00 and \$3.00. Clapp-Eastham variometer \$5.00. Remler panel and radiotron \$12.00. Navy coupler \$13.00. Rotary gap complete \$10.00. Everything listed same as new. Samuel Crow, 410 Buchanan St., Topeka, Kansas.

FOR SALE: Complete receiver and two step, exact copy of Grebe CR-6. No home stuff in it, merely assembled in fine portable cabinet. DX record reception. At cost of parts \$85. Barrett, 3150 Central Ave., Indianapolis, Ind.

FOR SALE: Hy-Rad rotor with electrodes \$3.00. Thordarson oil immersed condenser \$15.00. Joe Hill, 1572 Virginia St., Charleston, W. Va.

SPECIAL GARAGE MOTORS: Manufactured by the General Electric Co. 1 H.P. \$78.50—2 H.P. \$110.00—3 H.P. \$128.50—5 H.P. \$166.50. All sizes both single and Polyphase Motors for immediate delivery. Special charging generators all voltages. Write for catalog. Motor Sales Dept. 19, West End, Pittsburgh, Pa.

GENERATOR, 300 Volt, 300 Watt, Motor 1-6 H.P. Westinghouse MAKE OFFER—2000 ohm phones \$2.50. Benwood Rotor \$4.00. J. M. Simons, 2318 N. 19th St., Phila. Pa.

9BQ MUST GO. Have 1 K.W. Type R; oil and glass condenser; new, mounted Benwood disc; large O.T.; all on marble panel 20" x 24". Price \$70.00, or will trade for CW stuff in good shape. Bernard Hansen, care of Radio 9BQ, Logan, Iowa.

REGENERATIVE TUNER \$6.00. Wanted—ground switch. Winthrop Packard, Canton, Mass.

FOR SALE: A real bargain, never been used—one Grebe long wave regenerative receiver. One Grebe two stage amplifier. Baldwin Headset and four Vacuum Tubes. Price \$125.00. A. E. Laskin, 145 W. 28th St., New York City.

FOR SALE: Type H-1 Acme Transformer \$35, new; Benwood Quenched gap with 8000 RPM Motor mounted \$30, outfit cost \$90; Bargain, Boissonault Loud Speaker with transmitter attached, cord and plugs, new \$17; Grebe Regenerative Coupler type RKAB cost \$25, new \$18. E. C. Espy, Vandergrift, Pa. 8PN.

CLUB MEMBERS: We are giving special discounts on standard apparatus, write us. Stratfield Radio Laboratory, R. F. D. No. 1, Bridgeport, Conn.

WANTED: Genuine RA-6 Paragon \$25 spot cash. Sell Radiotron 201 new \$4.50. Barrett, 3150 Central Ave., Indianapolis.

BOTTLES 1 1/2" square 2 1/2" high 1 1/2" opening. Fine for storage B bats, 2c each plus shipping 16¢ per 100. Victor Andrew, Wooster, Ohio.

Crofts Library of Practical Electricity brand new \$20. Hawkins' Guides, good condition \$7.00; D.C. fan motor will generate 50V \$5.00; 2 1RD 750-3 Radisco coils, never used \$1.50 each; 2LRD 1200-3 Radisco coils, never used \$2.00 each; 3000 ohm Murdock head set, good condition \$4.00; 1500 ohm Murdock phone new \$2.00; Set of Marconi-Victor records never used \$5.00;

1/4 HP Racine AC-DC motor needs rewinding \$2.00. Ira F. Coon, Box 333, Lockport, Ill.

FOR SALE: Complete CW set of SZG with record of 1000 miles, including motor-generator, 2 VT-2 tubes, meters, etc., except storage battery. Price \$125. Complete rotary spark set 1 K. W. price \$65.00. Complete 1/2 K.W. Quenched Gap set \$55.00. A. J. Manning, 252 McKinley Ave., Salem, O.

FOR SALE: 1/2 K.W. transmitter, omnigraph and other apparatus. Harry Maule, Rawson Ave., Fremont, O.

FOR SALE: 50 Watt CW transmitter and Grebe Regenerative Receiver and Amplifier in use at 8DE—used 2 months—bargains—Roland Palmer, 470 E. Buchtel Ave., Akron, Ohio.

NEW SYNCHRONOUS MOTORS: \$27.50—1-5 HP. 220 Volt, 1800 RPM. Also new and slightly used 1/2 and 1/4 HP, 110 and 220 volt synchronous motors at very low prices. Stock limited—order at once. Stahl Rectifier Company, 1401 W. Jackson Blvd., Chicago, Ill.

SALE: Two new Radisco variometers and coupler, with dials, \$15.00. Wm. H. Kandel, St. Davids, Pa.

SELLING OUT used but not abused receiving apparatus, variable condensers, rheostats, sockets, honeycomb coils, etc. Write me for bargains. Ralph G. Roesch, 2924 Portmann Ave., Cleveland, Ohio.

One hundred dollars cash or certified check buys my spark transmitter as is, FOB 294 Ashmont St., Dorchester, Mass, 1AE.

SELL: Regenerative receiving set with Audion Control Cabinet \$18. 1" Spark Coil \$5. Murdock Transmitting Condenser \$1. Key \$1. Murdock 2000 ohm Receivers \$3. E. Schuessler, 2209 Wheeler St., Cincinnati, Ohio.

FOR SALE: 9A1X Transmitter. Mounted Acme 1KW. Dubilier condenser, .007; Kriowa Gap. High speed motor, Heavy OT, Large Key, etc., Cost \$149 Sell for \$90. cash. Short Wave Regenerative \$15. Seven honey comb coils \$10. Francis Schmitz, 429 No. Central Ave., Chicago.

SPECIAL GREBE OFFER. For a limited time we are supplying free of charge with each Grebe Type CR-3 Short Wave Regenerative Receiver the recognized standard among most all professional amateurs, your choice of a Paragon Vacuum Tube Control, a pair of 2000 ohm Murdock phones, a Radiotron UV-200, VT Detector, or a Moorhead A-P VT Detector. Type CR-3, \$65.00. Only new and high-grade apparatus carried in stock. Orders filled within 12 hours. Unsatisfactory goods subject to return in five days. The Kehler Radio Laboratories, Department 3, Abilene, Kansas.

FOR SALE: 2BG's Spark Transmitter, 1/4 KW Thordarson, latest type Dubilier Condenser 1 KW 25,000 Volt .007, Latest Super-Benwood Gap, Oscillation Transformer 0-5 H.W.A., Dubilier Kickback Preventer, Cost \$130.00, Sell \$70.00. George Gaede, Pompton Rd., Paterson, N. J.

FOR SALE: Complete station equipment; Thordarson transmitter, Grebe receiver. For particulars write, R. French, 1675 Pilgrim Pl., Akron, O.

450-Volt 200-Watt DC Generator \$25. 6-80 new storage battery \$12. Want regenerative. Arthur Thiesen, Oceanport, N. J.

"YOU TELL 'EM Baldwin, you Amplify." Baldwin phones used the world over. Baldwin phones, Brownlie phones, Vocalouds, Eldredge Meters, Amplifying Transformers, etc. All apparatus sent prepaid to southeastern amateurs. Write G. C. Coleman, Iron- dal, Ala.

RECEIVING CABINET 600-20,000 meters, including audion \$35.00. Murdock variable \$2.75. Perikon Detector \$1.00 Wireless books and magazines cheap. John Smith, 4416 Market, Philadelphia.

NOTICE—Turney Spider-Web Regenerative Unit \$5.50 postpaid. We carry a complete line of radio supplies. Send stamp for price list. Florman Radio Laboratory, 213 Fisher Ave., McPherson, Kansas.

DO WE? "Yes." We supply free of charge with each Radiotron UV-202 5 watt power tube (\$8.00) a special 5000 ohm size "M" grid leak (\$1.10), with midtap at 3500 ohms, and with each 50 watt Radiotron UV-203 power tube (\$30.00), a special 5000 ohm size "B" grid leak (\$1.65) with midtap at 2500 ohms. These grid leaks are designed and manufactured by the General Electric Co., for use with the Radiotron Power Tubes. Only new and high-grade apparatus carried in stock. Unsatisfactory tubes subject to return in five days. Orders are filled within twelve hours, and are shipped postpaid and insured. "Remember us." The Kehler Radio Laboratories, Department 3, Abilene, Kan.

RADIO APPARATUS built to order. If you haven't the time or equipment to make what you want write me for estimate R. Pringle, 1096 Ryde St., St. Paul, Minn.

FORD SPARK COILS, primary, secondary and core complete \$0.50. Eugene Grossman, 14 E. Read St., Baltimore, Md.

NEW DUBILIER Condenser type D101, 1/2 KW, .007 mid, 14,000 volts. Never used. \$22.50. Express collect. J. D. Bohannan, 228 16th Ave., Columbus, Ohio.

NEW MAGNAVONES \$36.50 postpaid. Carl Furburg, Fargo, N. Dak. R. #1.

1AA SELLING Murdock receiving transformer #344, \$7.00; Duck's Type C Sayville rotary gap \$10; E. I. Co., Loading Inductance #8487, \$1.50; Marconi Condenser Jar .001 mid., \$1.50.

FOR SALE: New Tresco Arlington Tuner \$8.00, Turney Spider Web \$5. R. M. Ireton, Saginaw, Mich.

A REAL SET, range 150 to 3000 meters. The most efficient and inexpensive set manufactured. It uses one bulb and vario-coupling. It eclipses all other sets of its wave length in sensitiveness. This set is sold complete for \$50.00 by Scott R. Coppins, Princeton, Ill.

BARGAIN—J-Ray noiseless enclosed rotary quenched gap in excellent condition, practically new, very efficient. Harry S. Weber, 1113 Walnut St., Dover, Ohio.

OAK CABINETS 7"x18"x6" finished light or dark oak, \$3.50. Other sizes in proportion. Litz. One and one half cents foot. Bakelite dials complete. #90. No. 22 DCC. 30 cts quarter pound. Meade Bakelite Radio Apparatus, 522 Central Ave., Brooklyn, N. Y.

FOR SALE: Amrad induction coil (6 volt primary) with quenched gap \$35. Radionron detector, \$4. Marconi transmitting tube, \$8. Clarence Kelley, 374 Beach St., Saco, Maine.

FOR SALE: Regenerative Receiver and detector control \$45.00, 1-10 HP 3400 RPM induction motor also 1/2 HP, 1750 RPM induction motor \$20.00 each—burned out UV-202 Radionron \$1. 1/2 KW Packard transformer \$10.00. Thomas A. Reid, 1219 N. Limestone St., Springfield, Ohio.

FOR SALE: Motor-generator 110 volt DC to 80 volt AC. 250 watt \$30.00. DC Generator 550 volt 200 watt \$40.00. Fine Western Electric VT II \$12.00 each. Five VT II Tube Sockets \$1.00 each. Chicago Radio Lab. Hyrad Gap \$20.00. 1/2 KW trans. for operation with 80 volt AC generator \$10. All apparatus in excellent condition. All letters answered. Alvin North, Jr., Troy, Ohio.

SYNCHRONOUS GAP MOTORS 1/2 HP 1,800 RPM, \$35. Guaranteed Satisfaction. Sent C.O.D. upon receipt of 1-3 of price. R. M. Carson, Colfax Ave., Springdale, Pa., Dealer, R.D. 8RQ.

FOR SALE: Grebe detector type RORH, brand new \$11. Acme modulation transformer completely mounted, new \$4.50. New Roller-Smith, H.W. Amp.—\$5.00. Money order only. Elmer G. Baier 253 Ninth St., Brooklyn, N. Y.

FOR SALE: Acme 500 watt CW transformer mounted 1000-1500 volts new \$21.00; 50 watt Radiotron used two hours good as new \$25.00; 0-5 Ilush General Radio radiation meter \$6.00. Postage extra. D. A. Hoffman, 50 S. Balch St., Akron, Ohio.

SELL: CRL Paragon \$40 Amplifigon AGN 1 \$40 Both \$75 like new. J. Paul Weirick, Loudonville, Ohio. 8AQZ.

SELL: Century Buzzer 75c, Murdock condenser 40c, Murdock detector 40c, 43 plate mounted variable \$3, Navy coupler \$9, \$55 CRL 2 step \$29, like new, RJ4 DeForest audion \$4, DeForest 1 to 1 amplifier \$1.50, porcelain DPDT switches 25c, Sears detector 75c, bell buzzer 25c, nicked VT socket 85c; others. Satisfaction or refund. H. J. Burhop, Manitowoc, Wisc., 92L.

SELLING OUT: Complete receiving outfit. Suitable for school or college \$200. Can hear all over world. For particulars, address R. F. Adams, 160 Cypress St., Providence, R. I.

FOR SALE: Dubilier .004 Transmitting Condenser; Single Circuit Long wave set; Grebe CR-2 two step Detector-Amplifier; WE phones and J tubes; 90 AH Battery—Plug Box. B-Batteries, Audiotron, Variables, Etc. All letters answered. R. B. Green, 1004 Hamilton Boulevard, Hagerstown, Md.

FOR SALE: Paragon RA Ten, New, \$70.00; Synchronous Motor, 1800 RPM, 1/2 HP, 220 Volt, new, \$40.00; Hyrad disc, \$7.00; 1/2 HP 3600 Motor, New, \$25.00. Home-made Paragon, \$30.00 Detector tube new, \$4.00; 2 Amplifying tubes, nearly new \$4.00 each; 1 pair

ALWAYS MENTION QST WHEN WRITING TO ADVERTISERS

LEARN WIRELESS AT HOME

The Demand for Good Wireless Operators Far Exceeds the Supply

The New York Wireless Institute will make you an operator—AT HOME—in your spare time—quickly, easily and thoroughly. No previous training or experience required. Our Home Study Course has been prepared by our Radio Expert, L. R. Krumm, formerly Chief Radio Inspector, Bureau Navigation, N. Y. Experts able to impart their practical and technical knowledge to YOU in an easy to understand way. The graded lessons mailed you will prove so fascinating that you will be eager for the next one. The instruments furnished free, will make it as easy to learn the Code as it was to learn to talk. All you will have to do, is to listen.

Travel the World Over A Wireless Operator can visit all parts of the world and receive fine pay and maintenance at the same time. Do you prefer a steady position without travel? There are many opportunities at the numerous land stations or with the Commercial Wireless or Steamship Companies.

BIG SALARIES Wireless operators receive salaries from \$125 to \$200 a month and it is only a stepping stone to better positions. There is practically no limit to your earning power. Men who but yesterday were Wireless Operators are now holding positions as Radio Engineers, Radio Inspectors, Radio Salesmen at salaries up to \$5000 a year.

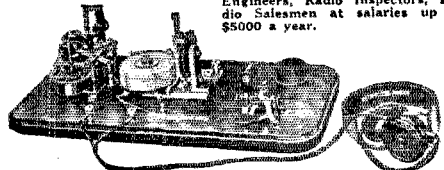

This wonderful Set for learning the code furnished free with our course

FREE Instruments and Text Books We furnish free to all students, during the course, the wonderful receiving and sending set exactly as reproduced in the illustration. This set is not loaned but GIVEN to all students completing the course.

The Transmitter shown is the celebrated Omnicograph used by several Departments of the U. S. Government and by the leading Universities, Colleges, Technical and Telegraph Schools throughout the U. S. and Canada. Start the Omnicograph, place the phone to your ear and this remarkable invention will send you Wireless Messages the same as though you were receiving them, through the air from a Wireless Station hundreds of miles away. When you apply for your license, the U. S. Government will test you with the Omnicograph—the same model Omnicograph as we furnish to our students. Ask any U. S. Radio Inspector to verify this.

FREE Post-Graduate Course A one month's Post-Graduate Course, if you desire at one of the largest Wireless Schools in N. Y. City, New York—the Wonder City—the largest port in the World and the Headquarters of every leading Wireless and Steamship Co.

NEW YORK WIRELESS INSTITUTE
Dept. 263 258 Broadway New York City

NEW YORK WIRELESS INSTITUTE
Dept. 263 258 Broadway New York City

Send me, free of charge, your booklet "How to Become an Expert Wireless Operator", containing full particulars of your Course, including your Free Instrument Offer.

Name
Address
City or Town State

Do You Know

Doctor Mu?

Murdock 3000 ohms fones, \$4.00; Detector and 2-step amplifier perfect condition, \$40.00; Paragon detector unit, new, \$4.50; W. E. Co. "E" tube \$9.00; 2 Remler rheostats, New \$1.00 each. 2 Amrad sockets, New, \$0.75 each; Wall type microphone, new \$3.00; Hand type microphone, \$5.00; Roller-Smith, 0-5 Amp. \$5.00; New Emerson, 400 volt generator DC, \$25.00; 2 Murdock, 43 plate condensers, in cases, \$3.50 each; 40 AH Storage Battery, \$6.00. Above apparatus guaranteed perfect condition when shipped. Twin City Radio Laboratory 185 W. 6th Street, St. Paul, Minn.

What are You Putting Out?
 General Radio Hot-Wire Ammeters
 and Milli-Ammeters

| | |
|--------------|--------|
| 0-1 AMP | \$7.75 |
| 0-2 1/2 " | 7.75 |
| 0-3 " | 7.75 |
| 0-5 " | 7.75 |
| 0-10 " | 7.75 |
| 100 Milli A. | 9.00 |
| 150 " " | 10.00 |
| 200 " " | 10.00 |

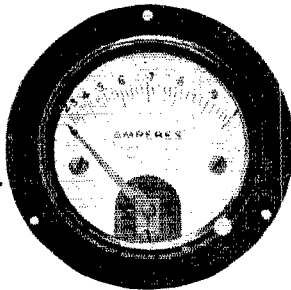

500-600V DONGAN METERS 17.50
BAKELITE PANELS

(BLACK OR BROWN)
 CUT THE SIZE YOU WANT THEM.
 1/8 in.....02 per sq. inch
 3/16 in.....03 per sq. inch
 1/4 in.....04 per sq. inch

SEND FOR LATEST CATALOG
 ESTAB. 1886.
DETROIT ELECTRIC CO.
 434 SHELBY ST., DETROIT, MICH.

Special Price Reductions

| | |
|-----------------------------------|---------|
| Paragon Control Panel with Ra- | \$10.50 |
| diotron Tube..... | |
| Audiotron Tube, two filaments.. | 5.50 |
| Radiotron Detector Tubes with a | |
| Combination Grid Leak Con- | |
| denser | 5.00 |
| Murdock 2000 Ohm Wireless Head | |
| Sets | 4.00 |
| Murdock 3000 Ohm Wireless Head | |
| Sets | 5.00 |
| Nickel Plated Binding Posts, Doz. | .80 |
| Rubber Cap Binding Posts, Doz. | 1.00 |
| #766 Eveready Large B Battery | 2.75 |
| 10 #703 Eveready 4.5 Volt | |
| Batteries | 3.25 |
| Chelsea Dial and Knob with Par- | |
| agon Rheostat..... | 2.50 |
| Ace 22.5 Volt small B Battery.. | .98 |
| Ace 22.5 Volt large B Battery.. | 1.75 |

Marko Storage Batteries
 6 Volt 20 to 40 Amp.....\$10.95
 6 Volt 40 to 60 Amp. Ford Type 15.00
 6 Volt 40 to 60 Amp. Large Type 16.00
 6 Volt 60 to 80 Amp. Ford Type 18.50
 6 Volt 60 to 80 Amp. Large Type 20.00
Prompt Attention Given to Mail Orders.
 The Above Prices are F. O. B. New York
Hygrade Electrical Novelty Co.
 41 West 125th St. New York

Real Radio Copy!

A ham since 1910, an advertising man all my life, I know radio, and I know copy! Lots of men know one—few know both. Am an ex-Marconi operator; at present copy chief of large agency.
 If you want your copy written by a man who knows YOUR business and his OWN, let me hear from you! This is purely a personal proposition; let us work together for bigger returns.
 Let me submit plans for your Fall campaign!
MR. MANUFACTURER
 Write "Copy Chief," % Q.S.T.

THE BEST IN WIRELESS TELEPHONE AND TELEGRAPH APPARATUS

Wholesale and Retail
VIRGINIA RADIO CO.
 Charlottesville, Virginia
3ATF

BUILD YOUR OWN SET

High quality, seamless paper tubing, in just the right sizes for constructing
Variometer 3 7/8" x 2" 25c
 4 1/4" x 2 1/2"
Vario-Coupler 3 7/8" x 2" 35c
 4 1/4" x 4 1/4"
3500 Meter Loose Coupler 45c
 3 1/4" x 7" 3 7/8" x 7"
6000 Meter Loose Coupler 65c
 3 7/8" x 7" 4 1/4" x 7"
 Postpaid to you—order to-day.
THE TAYLOR COMPANY
 Box 1043C Lowell, Mass.

DO YOU KNOW THAT:

1. BI-LATTICE COILS (duo-lateral) are the best type of inductances for long wave reception?
 2. SINGLE LAYER COILS for short wave reception can be approached only by the best re-generators?
 3. UNIT RECEIVING INDUCTANCES is our specialty?
 4. OUR BULLETIN will be mailed to you for 3c?
- P. J. STOCKWELL
 Box 157-A Reading, Mass.

ALKALINE STORAGE "B" BATTERIES

In oak cabinets, give years of service without expert attention. Are not harmed from overcharging, short circuiting or standing idle. Plain with clips, for single cell control, including rectifier, chemicals and directions. Thirty-two volts \$8.00; fifty volts \$10.00; sixty-eight volts \$12.00. Add 25% for batteries with control switches mounted in neatly engraved hard rubber panels. Pictures upon request.
KIMLEY ELECTRIC COMPANY
 290 Winslow Ave., Buffalo, N. Y.

-FOR YOUR CONVENIENCE-

QST'S INDEX OF ADVERTISERS IN THIS ISSUE

| | | | |
|---|------------------|--|-----|
| A. R. R. L. Convention..... | 70-71 | Magnavox Co., The..... | 104 |
| Acme Apparatus Co..... | 114 | Manhattan Elec'l Supply Co., Inc..... | 92 |
| Ajax Electric Co..... | 114 | Marshall-Gerken Co., The..... | 82 |
| All-American Electrical Mfrs..... | 100 | Massachusetts Radio & Tel. School..... | 106 |
| American Electric & Wireless Supply Co..... | 106 | McTighe Battery Co..... | 113 |
| American Radio & Research Corp..... | 100-Fourth Cover | Meyberg Co., Leo J..... | 88 |
| American Radio Sales & Service Co..... | 74 | Murdock Co., Wm. J..... | 101 |
| Andrea, F. A. D..... | 111 | Mutual Purchasers Assn..... | 82 |
| Atlantic Radio Co..... | Second Cover | | |
| Atlantic Radio Supplies Co..... | 81 | | |
| Audiotron Mfg. Co..... | 8 | | |
| | | New York Wireless Institute..... | 117 |
| | | Newman-Stern Co..... | 98 |
| Barriette Radio Shop..... | 115 | | |
| Benwood Co., The..... | 95-103 | Pacent Electric Co., Inc..... | 4 |
| Brandes, C. Inc..... | 109 | Pacific Radio Supplies Co..... | 81 |
| Bronx Radio Equipment Co..... | 108 | Paquin, J. M..... | 110 |
| Brown, Landone..... | 64-65 | Parkin Mfg. Co..... | 94 |
| Bunnell & Co., J. H..... | 106 | Penn. Radio Apparatus Co..... | 110 |
| Burgess Battery Co..... | 38 | Penn. Wireless Mfg. Co..... | 112 |
| Burgess Electric Co..... | 109 | Philadelphia School of Wireless Tel..... | 77 |
| | | Pitts Co., F. D..... | 39 |
| Carter Electric Co..... | 109 | Pioneer Electric Co..... | 112 |
| Central Electric & Lock Co..... | 102 | Precision Equipment Co., The..... | 113 |
| Chelsea Radio Co..... | 110 | | |
| Chicago Radio Apparatus Co..... | 91 | Quaker Light Supply Co..... | 96 |
| Chicago Radio Laboratory..... | 75 | | |
| Cino Radio Mfg. Co..... | 84 | | |
| Clapp-Eastham Co..... | 80 | Radio Audion Co..... | 69 |
| Colebrook-Hamilton Battery Co..... | 115 | Radio Construction Co..... | 115 |
| Connecticut Tel. & Elec. Co..... | 68 | Radio Corporation of America..... | 85 |
| "Copy Chief"..... | 118 | Radio Distributing Co..... | 1 |
| Continental Radio & Elec. Corpn..... | Third Cover | Radio Electric Co..... | 92 |
| Corwin & Co., A. H..... | 120 | Radio Equipment Co., Boston..... | 79 |
| Coto-Coil Co..... | 96 | Radio Shop The..... | 93 |
| Crosley Mfg. Co..... | 111 | Radioelectric Shop..... | 94 |
| | | Radio Specialty Co., N. Y. C..... | 99 |
| DeForest Radio Tel. & Tel. Co..... | 107 | Radio Testing Station..... | 110 |
| Detroit Electric Co..... | 118 | Ray-Di-Co..... | 86 |
| Doubleday-Hill Electric Co..... | 108 | Remler Radio Mfg. Co..... | 2 |
| Dreyfuss Sales Corpn..... | 98 | Rhamstine, J. Thos..... | 108 |
| | | Rose Radio Supply..... | 114 |
| Eastern Radio Institute..... | 87 | | |
| Eby Mfg. Co., The H. H..... | 90 | Saginaw Radio Electric Co..... | 72 |
| Edwards-Noble Co..... | 114 | Sayre-Level Radio Co..... | 105 |
| Electric Machine Co..... | 98 | Schick, William..... | 105 |
| Electric Specialty Co..... | 66 | Ship Owners Radio Service, Inc..... | 102 |
| Electrical Specialty Co..... | 78 | Shotton Radio Mfg. Co., The..... | 67 |
| Empire Radio Equipment Co..... | 102 | Simplex Radio Co..... | 107 |
| Empyrean Radio Co..... | 88 | Somerville Radio Laboratory..... | 104 |
| | | Stockwell, P. J..... | 118 |
| Federal Tel. & Tel. Co..... | 68 | | |
| Firth & Co., John..... | 88 | Taylor Co., The..... | 118 |
| Formica Insulation Co..... | 76 | Telephone Maintenance Co..... | 62 |
| France Mfg. Co., The..... | 96 | Thordarson Elec. Mfg. Co..... | 73 |
| | | Tresco..... | 108 |
| General Radio Co..... | 84 | Tuska Co., The C. D..... | 65 |
| Glenhurst Radio Laboratories..... | 112 | Twin City Radio Laboratory..... | 107 |
| Grebe & Co., A. H..... | 111 | | |
| | | Vimy Supply Co., The..... | 115 |
| Hygrade Electric Novelty Co..... | 118 | Virginia Radio Co..... | 118 |
| Independent Radio Supply Co..... | 103 | | |
| J-Ray Mfg. Co..... | 86 | Westinghouse Elec. & Mfg. Co..... | 97 |
| Jewell Electrical Instrument Co..... | 115 | Weston Elec'l Instrument Co..... | 72 |
| Johnson, G. F..... | 106 | Whitall Electric Co..... | 90 |
| Johnston, Charles H..... | 114 | Winkler, Frederick Jr..... | 112 |
| | | Wilcox Laboratories, Inc., The..... | 94 |
| Karlowa Radio Corpn., The..... | 76 | Wireless Equipment Co..... | 63 |
| Kelly & Phillips..... | 114 | Wireless Improvement Co..... | 70 |
| Kennedy Co., The Colin B..... | 78 | Wireless Press, Inc..... | 90 |
| Keystone Wire Co..... | 113 | Wireless Mfg. Co..... | 80 |
| Killoch Co., David..... | 92 | Wireless Shop, The..... | 105 |
| Kimley Electric Co..... | 118 | Wolfe Electric Co..... | 86 |
| Kraus Battery Co..... | 115 | | |

ALWAYS MENTION QST WHEN WRITING TO ADVERTISERS

STATION TYPE
(In handsome mahogany cabinet as shown.)

\$30.00

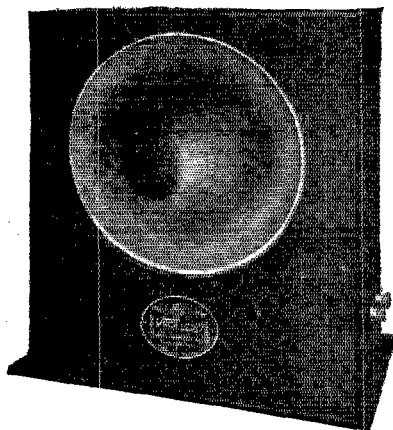

Laboratory Type
(Mounted on metal base, adjustable height.)

\$25.00

THE

VOCALLOUD

THE IDEAL loud-speaker. Requires no batteries, no adjustments, no extra equipment whatever! Just hook VOCALLOUD right on to your receiving apparatus and

listen to your signals,—QSA *all over your house!* Uses genuine Baldwin reproducer,—equally good for telephone and telegraph. Your order shipped at once!

CORWIN'S improved SWITCH LEVER

Sure contacts, smooth operation, handsome appearance,—all are characteristics of this improved switch. Many switches give their manufacturers more profit,—none give their users more satisfaction. Try a Corwin Switch. *As good as it looks!*

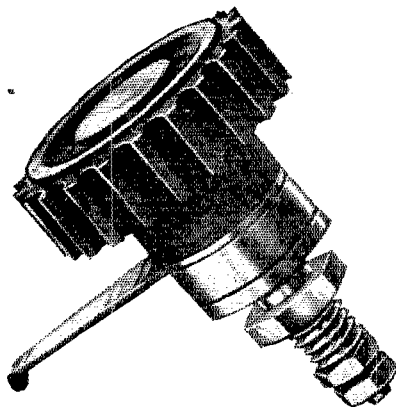

PRICE:
90 cents
Postage,
5 cents.

Composition knob, identical with knobs used on standard #67 Corwin Dial. Brass shaft is moulded right into knob,—*it can never come loose.* Blade, bushings, etc. nickel-plated brass. Contact radius, 1 3/4".

UNIVERSAL-COIL MOUNTING PLUGS

For Radisco and all hand wound coils. No bending, no filing, they fit exactly in the first place.

80 cents, postpaid

All orders for apparatus not listed as postpaid must be accompanied by postage charges.

Send your order today.

**CORWIN'S
1921
CATALOG
10c**

Send for your copy today!

NEW RADISCO VARIO-COUPLER

"Accurate to the .002 part of an inch. Moulded base, Formica tube, all metal parts brass.

\$7.50 postpaid

Remember Corwin's reputation for shipping mail orders promptly and in perfect condition.

A. H. CORWIN & CO.
Dept. D4.4 W. Park St., Newark, N.J.

PARAGON R.A.TEN

Protection Against Regrets Absolutely Guaranteed by Originator's Name

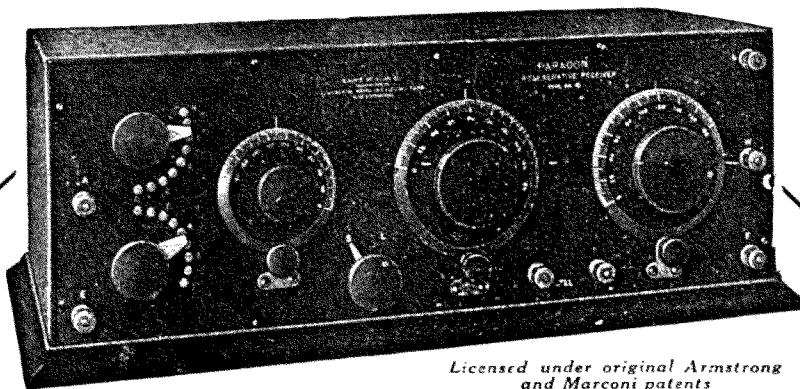

*Licensed under original Armstrong
and Marconi patents*

SEALS BROKEN-- *by popular request!*

NO MORE SEALS ON PARAGON R.A. TEN receivers,—take the panel off before you buy,—see for yourself the splendid workmanship behind the handsome cabinet,—and you will better understand the reasons for PARAGON'S unequalled selectivity and amplification. *Ask your radio dealer to show you the inside construction of a Paragon. If he hasn't one in stock, he will gladly get one if you ask for it.*

PARAGON R.A. TEN is endorsed by leading amateurs. Scores of letters on file at our office, testify to its marvellous results. The latest one as we go to press is from J. O. Smith, of Valley Stream, L. I. He says, "The PARAGON R.A. TEN receiving set... has proved entirely satisfactory and has done everything you claimed it would do. It is remarkably efficient and selective on all wave lengths. It has proved to be especially satisfactory in C.W. work, because of the complete absence of capacity effects."

Such endorsement is ample evidence that PARAGON R.A. TEN is well worth its \$85.00 price.

SPECIAL OPPORTUNITY TO RADIO CLUBS
For a short time only, radio clubs in good standing will have the opportunity of securing a genuine PARAGON R.A. TEN receiver for the club house absolutely FREE. Have your President or Secretary write on the club's letterhead for particulars at once.

CONTINENTAL RADIO and ELECTRIC CORPORATION

J. DiBlasi,
Sec.

Dep't. B27, 6 Warren St., New York

J. Stanley,
Treas.

EXCLUSIVE WHOLESALE DISTRIBUTORS FOR PARAGON AND PHONETRON



The Recognized Symbol of Superior Performance

SO that all radiomen may know their nearest dependable source of supply when in need of equipment we publish this list of reliable dealers who stock leading brands of apparatus, **including Amrad**: Give the dealer nearest you an opportunity to demonstrate his ability to serve you promptly and accurately.

FIRST DISTRICT

C. B. Chase, 94 Railroad street, St. Johnsbury, Vt.
Francis L. Stanley Company, 302 Essex St., Salem, Mass.
George A. Hill Co., 338 Middlesex Avenue, Lowell, Mass.
Wood Electrical Construction Co., 72 Exchange St., Lynn, Mass.
F. D. Pitts Company, 12 Park Square, Boston, Mass.
DeLancey, Felch & Co., 12 Meeting St., Pawtucket, R. I.
Whittall Electric Co., 336 Bridge St., Springfield, Mass.
W. D. Kendall Company, 268 Main Street, Worcester, Mass.
Crown Light Supply Company, 110 Crown St., New Haven, Conn.
"Ark" Radio Supply, Shelton, Conn.
Spafford's, 211 Trumbull St., Hartford, Conn.
Berkshire Electric Co., 77 Eagle St., Pittsfield, Mass.

SECOND DISTRICT

Shotton Radio Manufacturing Co., 8 Market St., Albany, N. Y.
American Electric Technical Appliance Co., 235 Fulton St., New York City.
Continental Radio & Electric Corp., 6 Warren St., New York City.
Westchester Electric Appliance Co., 253 South Broadway, Yonkers, N. Y.

THIRD DISTRICT

Joseph M. Zamoiski Co., 19 North Liberty St., Baltimore, Md.
Jere Woodring & Co., Hazelton, Penna.
Phil. School of Wireless Telegraphy, 1533 Pine St., Philadelphia, Pa.
Shotton Radio Mfg. Co., Box #3, Scranton, Pa.
White & Boyer Co., 812 13th St., N. W., Washington, D. C.
Howell Brothers, 602 East Broad St., Richmond, Va.
Lancaster Elec. Supply & Constr. Co., Lancaster, Pa.

FOURTH DISTRICT

Carter Electric Co., 63 Peachtree St., Atlanta, Ga.

FIFTH DISTRICT

Southwest Radio Supply Co., 217 North St., Paul St., Dallas, Tex.
Hurlburt-Still Elec. Co., Capitol Ave. & Fannin St., Houston, Tex.
Union Elec. Co., 42 North Second St., Memphis, Tenn.
Herbrick & Lawrence, 607 Church St., Nashville, Tenn.
Nola Radio Company, 134 Chartes St., New Orleans, La.

SIXTH DISTRICT

Western Radio Electric Co., 550 South Flower St., Los Angeles, Calif.
California Electric Supply Co., 643 Mission St., San Francisco, Cal.
Southern Electrical Co., 3d & E Sts., San Diego, Calif.
Noon's Electric Shop, 188 Grand Ave., Nogales, Arizona.

SEVENTH DISTRICT

Glasgow Electric Shop, Orpheum Bldg., Glagsow, Montana.
Northwest Radio Service Co., 609 Fourth Ave., Seattle, Wash.

CANADA

Scientific Experimenter, Ltd., 11 St. Sacramento St., 33 McGill College Ave., Montreal (and all branches.)

EIGHTH DISTRICT

Rudolph Schmidt & Co., 51 Mair St., East, Rochester, N. Y.
Bear-Cat Battery Service, Lemoyne, Pa.
Radio Electric Company 3807 Fifth Ave., Pittsburgh, Pa.
Radioelectric Shop, 919 Huron Road, Cleveland, Ohio.
Newman-Stern Company, East 12th St. & Walnut Ave., Cleveland, Ohio.
Precision Equipment Co., 2487 Gilbert Ave., Cincinnati, Ohio.
Kramer Hardware Company, 138 East Third St., Dayton, Ohio.
Henry L. Walker Co., 27 Jefferson Ave., East, Detroit, Mich.
Barker-Fowler Electric Co., 117 E. Michigan Ave., Lansing, Mich.

NINTH DISTRICT

The Alamo Sales Corporation, People's Bank Bldg., Indianapolis, Ind.
Chicago Radio Apparatus Co., 508 South Dearborn St., Ind., Chicago, Ill.
U. of I. Supply Store, Champaign, Illinois.
Klaus Radio Company, Eureka, Illinois.
Pioneer Electric Company, 187 East 5th St., St. Paul, Minn.
Sterling Electric Company, 29 Fifth St., South, Minneapolis, Minn.
Karlowa Radio Corporation, 611 Best Bldg., Rock Island, Ill.
Linze Electrical Supply Co., 1129 Olive St., St. Louis, Mo.
Central Radio Co., Inc., 316 East 19th St., Kansas City, Mo.
Wolfe Electric Company, 318 South 17th St., Omaha, Nebr.
Bullock's Sporting Goods, Nebraska.

(Send 10c stamps to our nearest office for complete catalog.)

See Important Announcement on Page 87

AMERICAN RADIO AND RESEARCH CORPORATION

13 Park Row
NEW YORK CITY

205 College Avenue
MEDFORD HILLSIDE, MASS.

608 Souh Dearborn St
CHICAGO, ILLINOIS